

## LM4562 Dual High-Performance, High-Fidelity Audio Operational Amplifier

Check for Samples: [LM4562](#)

### FEATURES

- Easily Drives 600Ω Loads
- Optimized for Superior Audio Signal Fidelity
- Output Short Circuit Protection
- PSRR and CMRR Exceed 120dB (Typ)
- SOIC, PDIP, and TO-99 Packages

### APPLICATIONS

- Ultra High-Quality Audio Amplification
- High-Fidelity Preamplifiers
- High-Fidelity Multimedia
- State-of-the-Art Phono Pre Amps
- High-Performance Professional Audio
- High-Fidelity Equalization and Crossover Networks
- High-Performance Line Drivers
- High-Performance Line Receivers
- High-Fidelity Active Filters

### KEY SPECIFICATIONS

- Power Supply Voltage Range:  $\pm 2.5\text{V}$  to  $\pm 17\text{V}$
- THD+N ( $A_V = 1$ ,  $V_{OUT} = 3V_{RMS}$ ,  $f_{IN} = 1\text{kHz}$ )
  - $R_L = 2\text{k}\Omega$ : 0.00003% (typ)
  - $R_L = 600\Omega$ : 0.00003% (typ)
- Input Noise Density:  $2.7\text{nV}/\sqrt{\text{Hz}}$  (typ)
- Slew Rate:  $\pm 20\text{V}/\mu\text{s}$  (typ)
- Gain Bandwidth Product: 55MHz (typ)
- Open Loop Gain ( $R_L = 600\Omega$ ): 140dB (typ)
- Input Bias Current: 10nA (typ)
- Input Offset Voltage: 0.1mV (typ)
- DC Gain Linearity Error: 0.000009%

### DESCRIPTION

The LM4562 is part of the ultra-low distortion, low-noise, high-slew-rate operational amplifier series optimized and fully specified for high-performance, high-fidelity applications. Combining advanced leading-edge process technology with state-of-the-art circuit design, the LM4562 audio operational amplifiers deliver superior audio signal amplification for outstanding audio performance. The LM4562 combines extremely low voltage noise density ( $2.7\text{nV}/\sqrt{\text{Hz}}$ ) with vanishingly low THD+N (0.00003%) to easily satisfy the most demanding audio applications. To ensure that the most challenging loads are driven without compromise, the LM4562 has a high slew rate of  $\pm 20\text{V}/\mu\text{s}$  and an output current capability of  $\pm 26\text{mA}$ . Further, dynamic range is maximized by an output stage that drives 2kΩ loads to within 1V of either power supply voltage and to within 1.4V when driving 600Ω loads.

The LM4562's outstanding CMRR (120dB), PSRR (120dB), and  $V_{OS}$  (0.1mV) give the amplifier excellent operational amplifier DC performance.

The LM4562 has a wide supply range of  $\pm 2.5\text{V}$  to  $\pm 17\text{V}$ . Over this supply range the LM4562's input circuitry maintains excellent common-mode and power supply rejection, as well as maintaining its low input bias current. The LM4562 is unity gain stable. This Audio Operational Amplifier achieves outstanding AC performance while driving complex loads with values as high as 100pF.

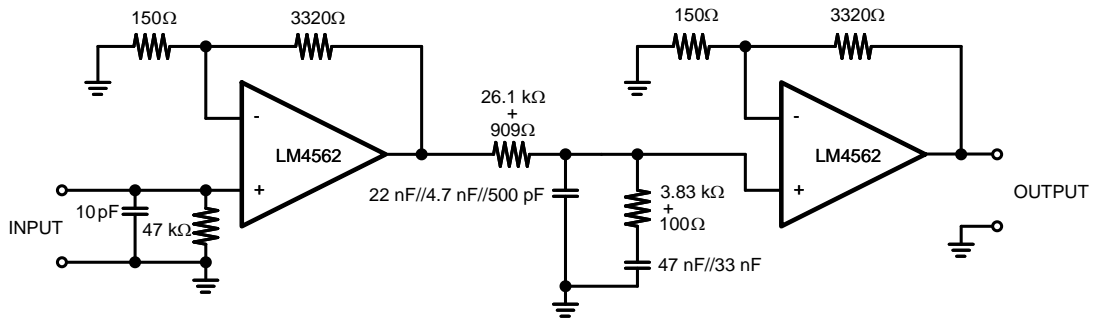
The LM4562 is available in an 8-lead narrow body SOIC, an 8-lead PDIP, and an 8-lead TO-99. Demonstration boards are available for each package.



Please be aware that an important notice concerning availability, standard warranty, and use in critical applications of Texas Instruments semiconductor products and disclaimers thereto appears at the end of this data sheet.

All trademarks are the property of their respective owners.

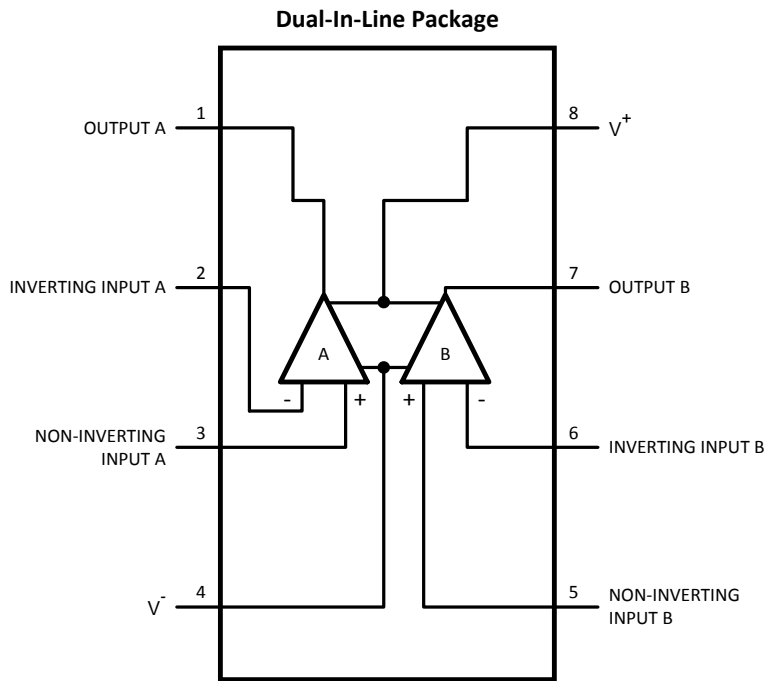
**TYPICAL APPLICATION**



A. 1% metal film resistors, 5% polypropylene capacitors

**Figure 1. Passively Equalized RIAA Phono Preamplifier**

**CONNECTION DIAGRAMS**



**Figure 2. 8-Lead SOIC (D Package)  
8-Lead PDIP (P Package)**

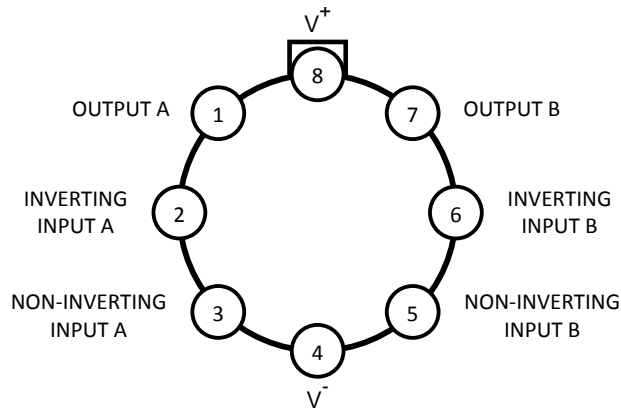


Figure 3. 8-Lead TO-99 (LMC Package)



These devices have limited built-in ESD protection. The leads should be shorted together or the device placed in conductive foam during storage or handling to prevent electrostatic damage to the MOS gates.

### ABSOLUTE MAXIMUM RATINGS<sup>(1)(2)(3)</sup>

Power Supply Voltage ( $V_S = V^+ - V^-$ )	36V
Storage Temperature	-65°C to 150°C
Input Voltage	(V-) - 0.7V to (V+) + 0.7V
Output Short Circuit <sup>(4)</sup>	Continuous
Power Dissipation	Internally Limited
ESD Susceptibility <sup>(5)</sup>	2000V
ESD Susceptibility <sup>(6)</sup>	
Pins 1, 4, 7 and 8	200V
Pins 2, 3, 5 and 6	100V
Junction Temperature	150°C
Thermal Resistance	
$\theta_{JA}$ (D)	145°C/W
$\theta_{JA}$ (P)	102°C/W
$\theta_{JA}$ (LMC)	150°C/W
$\theta_{JC}$ (LMC)	35°C/W
Temperature Range	
$T_{MIN} \leq T_A \leq T_{MAX}$	-40°C $\leq$ $T_A$ $\leq$ 85°C
Supply Voltage Range	$\pm 2.5V \leq V_S \leq \pm 17V$

- (1) *Absolute Maximum Ratings* indicate limits beyond which damage to the device may occur.
- (2) Operating Ratings indicate conditions for which the device is functional, but do not ensure specific performance limits. For ensured specifications and test conditions, see the Electrical Characteristics. The ensured specifications apply only for the test conditions listed. Some performance characteristics may degrade when the device is not operated under the listed test conditions.
- (3) If Military/Aerospace specified devices are required, please contact the Texas Instruments Sales Office/Distributors for availability and specifications.
- (4) Amplifier output connected to GND, any number of amplifiers within a package.
- (5) Human body model, 100pF discharged through a 1.5k $\Omega$  resistor.
- (6) Machine Model ESD test is covered by specification EIAJ IC-121-1981. A 200pF cap is charged to the specified voltage and then discharged directly into the IC with no external series resistor (resistance of discharge path must be under 50 $\Omega$ ).

## ELECTRICAL CHARACTERISTICS FOR THE LM4562<sup>(1)(2)</sup>

The specifications apply for  $V_S = \pm 15V$ ,  $R_L = 2k\Omega$ ,  $f_{IN} = 1kHz$ ,  $T_A = 25^\circ C$ , unless otherwise specified.

Symbol	Parameter	Conditions	LM4562		Units (Limits)
			Typical <sup>(3)</sup>	Limit <sup>(4)</sup>	
THD+N	Total Harmonic Distortion + Noise	$A_V = 1$ , $V_{OUT} = 3V_{rms}$ $R_L = 2k\Omega$ $R_L = 600\Omega$	0.00003 0.00003	0.00009	% (max)
IMD	Intermodulation Distortion	$A_V = 1$ , $V_{OUT} = 3V_{RMS}$ Two-tone, 60Hz & 7kHz 4:1	0.00005		%
GBWP	Gain Bandwidth Product		55	45	MHz (min)
SR	Slew Rate		$\pm 20$	$\pm 15$	V/ $\mu s$ (min)
FPBW	Full Power Bandwidth	$V_{OUT} = 1V_{P-P}$ , $-3dB$ referenced to output magnitude at $f = 1kHz$	10		MHz
$t_s$	Settling time	$A_V = -1$ , 10V step, $C_L = 100pF$ 0.1% error range	1.2		$\mu s$
$e_n$	Equivalent Input Noise Voltage	$f_{BW} = 20Hz$ to 20kHz	0.34	0.65	$\mu V_{RMS}$ (max)
	Equivalent Input Noise Density	$f = 1kHz$ $f = 10Hz$	2.7 6.4	4.7	$nV/\sqrt{Hz}$ (max)
$i_n$	Current Noise Density	$f = 1kHz$ $f = 10Hz$	1.6 3.1		$pA/\sqrt{Hz}$
$V_{OS}$	Offset Voltage		$\pm 0.1$	$\pm 0.7$	mV (max)
$\Delta V_{OS}/\Delta Temp$	Average Input Offset Voltage Drift vs Temperature	$-40^\circ C \leq T_A \leq 85^\circ C$	0.2		$\mu V/^\circ C$
PSRR	Average Input Offset Voltage Shift vs Power Supply Voltage	$\Delta V_S = 20V^{(5)}$	120	110	dB (min)
ISO <sub>CH-CH</sub>	Channel-to-Channel Isolation	$f_{IN} = 1kHz$ $f_{IN} = 20kHz$	118 112		dB
$I_B$	Input Bias Current	$V_{CM} = 0V$	10	72	nA (max)
$\Delta I_{OS}/\Delta Temp$	Input Bias Current Drift vs Temperature	$-40^\circ C \leq T_A \leq 85^\circ C$	0.1		nA/ $^\circ C$
$I_{OS}$	Input Offset Current	$V_{CM} = 0V$	11	65	nA (max)
$V_{IN-CM}$	Common-Mode Input Voltage Range		+14.1 -13.9	(V+) - 2.0 (V-) + 2.0	V (min)
CMRR	Common-Mode Rejection	$-10V < V_{cm} < 10V$	120	110	dB (min)
$Z_{IN}$	Differential Input Impedance		30		k $\Omega$
	Common Mode Input Impedance	$-10V < V_{cm} < 10V$	1000		M $\Omega$
$A_{VOL}$	Open Loop Voltage Gain	$-10V < V_{out} < 10V$ , $R_L = 600\Omega$	140	125	dB (min)
		$-10V < V_{out} < 10V$ , $R_L = 2k\Omega$	140		
		$-10V < V_{out} < 10V$ , $R_L = 10k\Omega$	140		
$V_{OUTMAX}$	Maximum Output Voltage Swing	$R_L = 600\Omega$	$\pm 13.6$	$\pm 12.5$	V (min)
		$R_L = 2k\Omega$	$\pm 14.0$		
		$R_L = 10k\Omega$	$\pm 14.1$		
$I_{OUT}$	Output Current	$R_L = 600\Omega$ , $V_S = \pm 17V$	$\pm 26$	$\pm 23$	mA (min)
$I_{OUT-CC}$	Instantaneous Short Circuit Current		+53 -42		mA
$R_{OUT}$	Output Impedance	$f_{IN} = 10kHz$ Closed-Loop Open-Loop	0.01 13		$\Omega$

(1) Absolute Maximum Ratings indicate limits beyond which damage to the device may occur.

(2) Operating Ratings indicate conditions for which the device is functional, but do not ensure specific performance limits. For ensured specifications and test conditions, see the Electrical Characteristics. The ensured specifications apply only for the test conditions listed. Some performance characteristics may degrade when the device is not operated under the listed test conditions.

(3) Typical specifications are specified at  $+25^\circ C$  and represent the most likely parametric norm.

(4) Tested limits are specified to National's AOQL (Average Outgoing Quality Level).

(5) PSRR is measured as follows:  $V_{OS}$  is measured at two supply voltages,  $\pm 5V$  and  $\pm 15V$ .  $PSRR = |20\log(\Delta V_{OS}/\Delta V_S)|$ .

**ELECTRICAL CHARACTERISTICS FOR THE LM4562<sup>(1)(2)</sup> (continued)**

The specifications apply for  $V_S = \pm 15V$ ,  $R_L = 2k\Omega$ ,  $f_{IN} = 1kHz$ ,  $T_A = 25^\circ C$ , unless otherwise specified.

Symbol	Parameter	Conditions	LM4562		Units (Limits)
			Typical <sup>(3)</sup>	Limit <sup>(4)</sup>	
$C_{LOAD}$	Capacitive Load Drive Overshoot	100pF	16		%
$I_S$	Total Quiescent Current	$I_{OUT} = 0mA$	10	12	mA (max)

**TYPICAL PERFORMANCE CHARACTERISTICS**

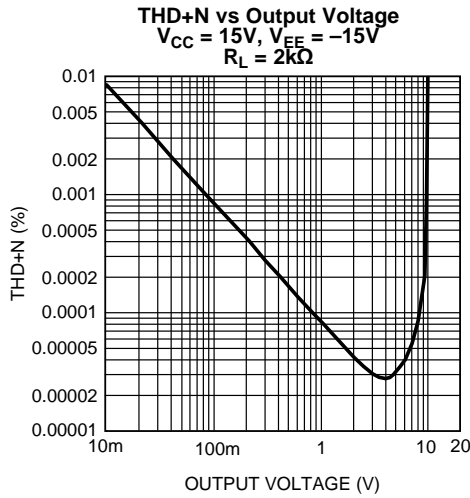


Figure 4.

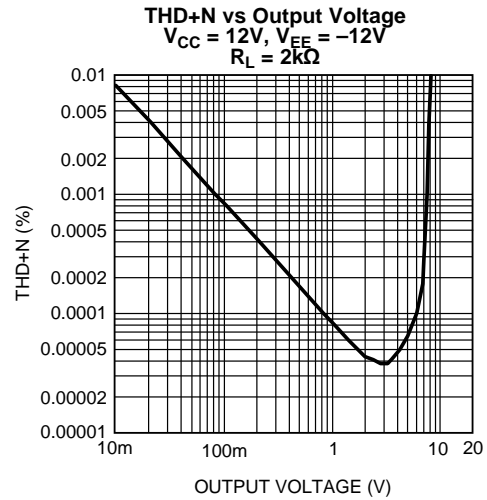


Figure 5.

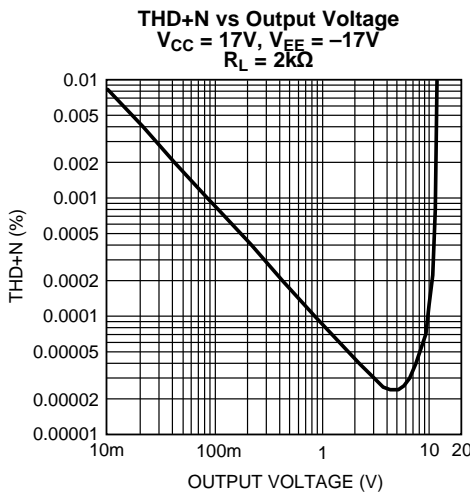


Figure 6.

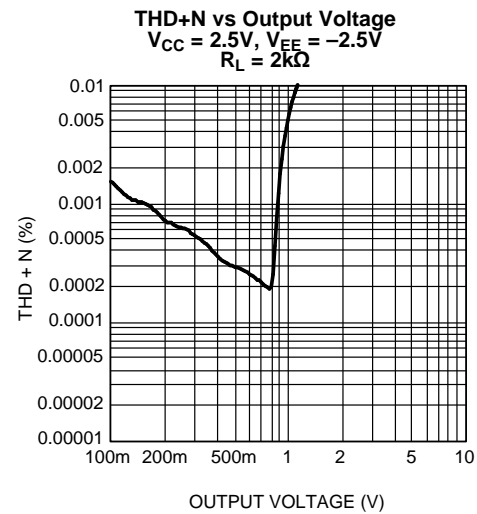


Figure 7.

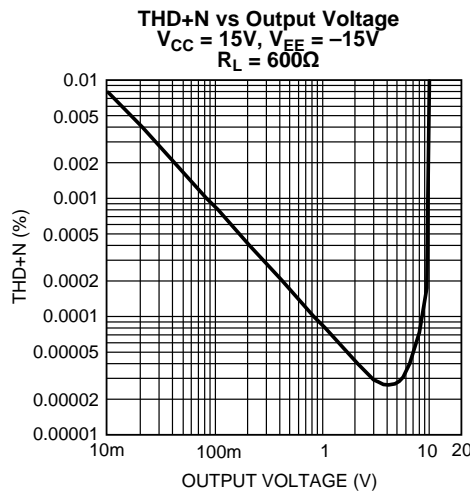


Figure 8.

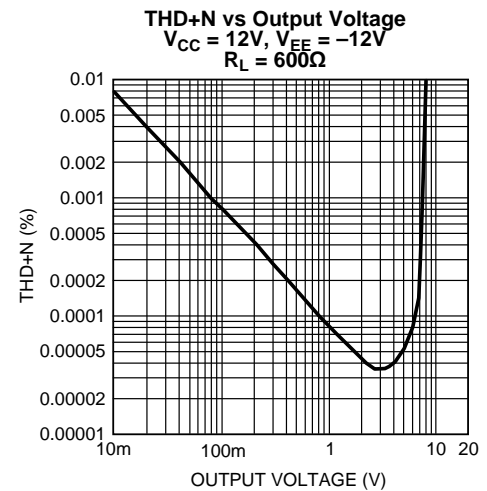


Figure 9.

**TYPICAL PERFORMANCE CHARACTERISTICS (continued)**

**THD+N vs Output Voltage**  
 $V_{CC} = 17V, V_{EE} = -17V$   
 $R_L = 600\Omega$

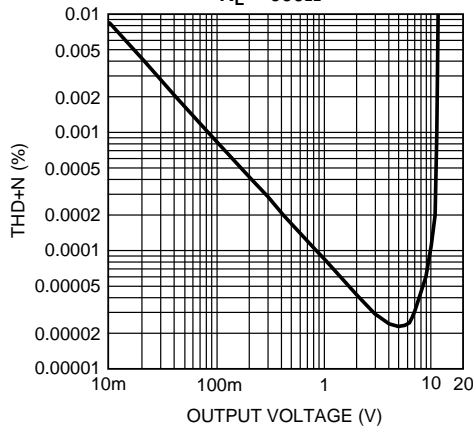


Figure 10.

**THD+N vs Output Voltage**  
 $V_{CC} = 2.5V, V_{EE} = -2.5V$   
 $R_L = 600\Omega$

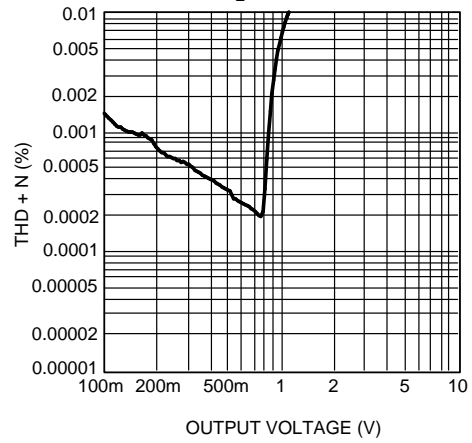


Figure 11.

**THD+N vs Output Voltage**  
 $V_{CC} = 15V, V_{EE} = -15V$   
 $R_L = 10k\Omega$

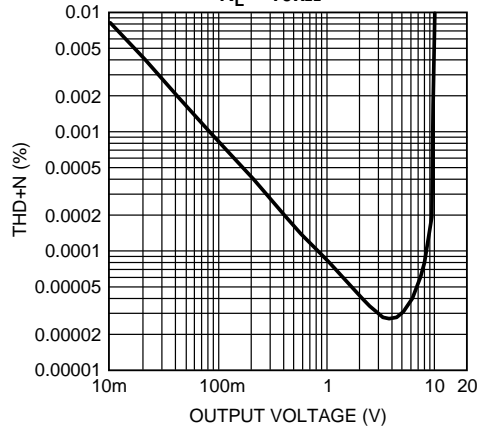


Figure 12.

**THD+N vs Output Voltage**  
 $V_{CC} = 12V, V_{EE} = -12V$   
 $R_L = 10k\Omega$

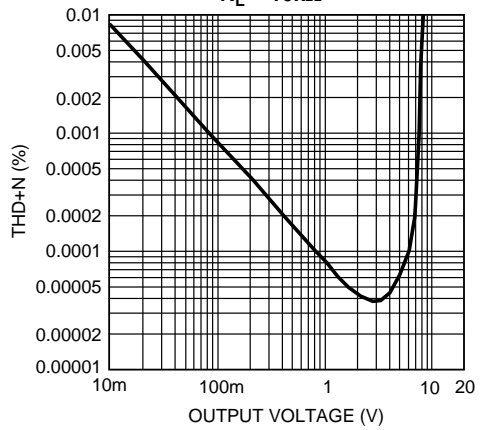


Figure 13.

**THD+N vs Output Voltage**  
 $V_{CC} = 17V, V_{EE} = -17V$   
 $R_L = 10k\Omega$

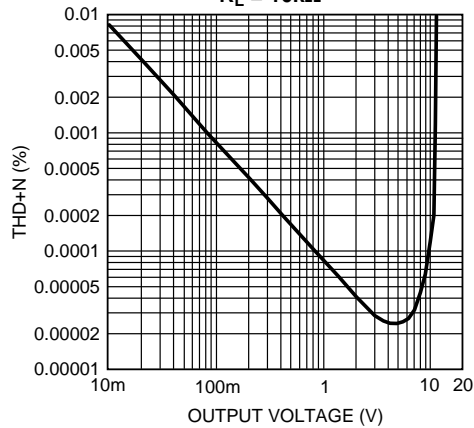


Figure 14.

**THD+N vs Output Voltage**  
 $V_{CC} = 2.5V, V_{EE} = -2.5V$   
 $R_L = 10k\Omega$

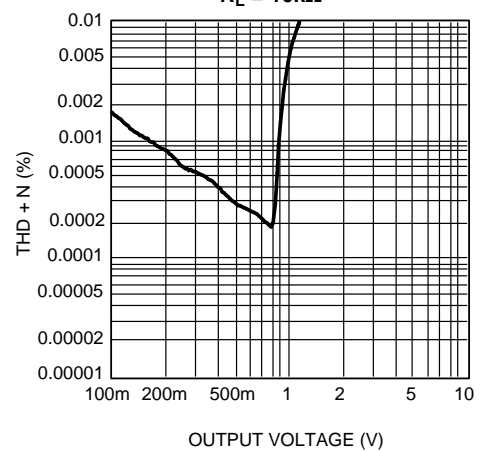


Figure 15.

**TYPICAL PERFORMANCE CHARACTERISTICS (continued)**

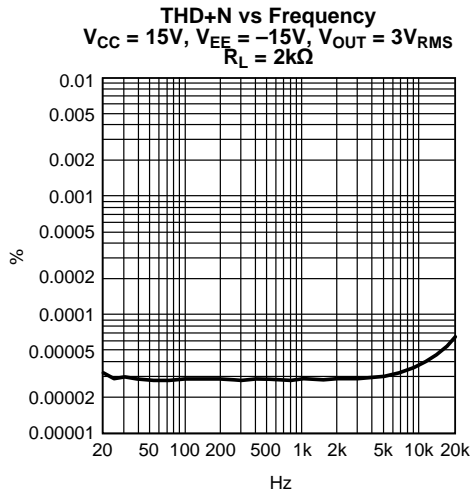


Figure 16.

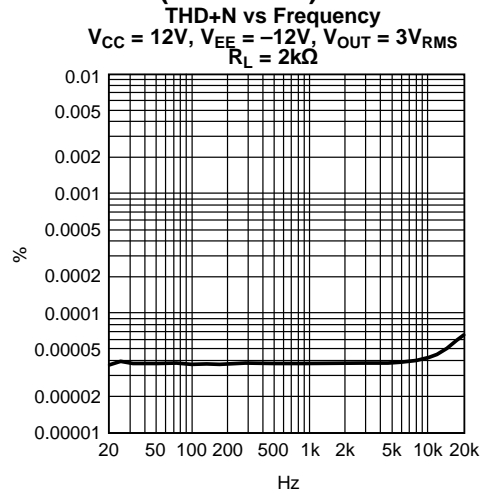


Figure 17.

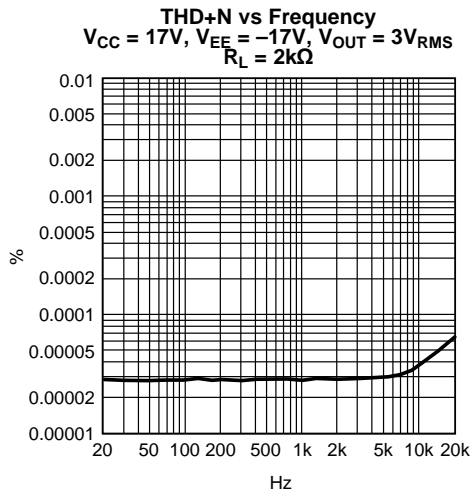


Figure 18.

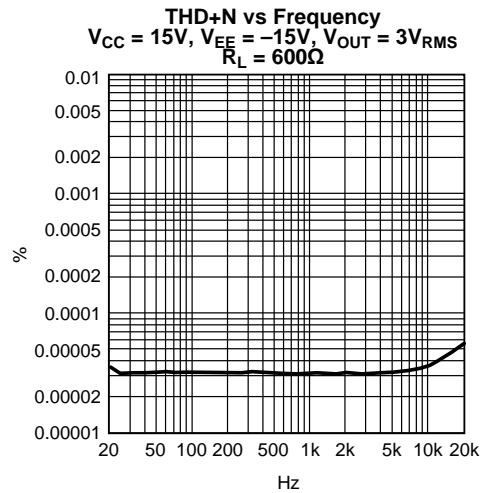


Figure 19.

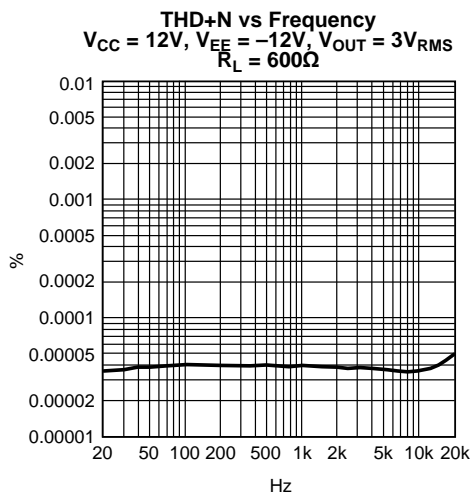


Figure 20.

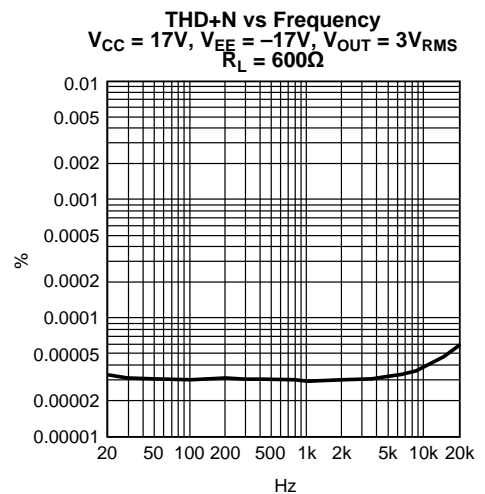


Figure 21.



**TYPICAL PERFORMANCE CHARACTERISTICS (continued)**

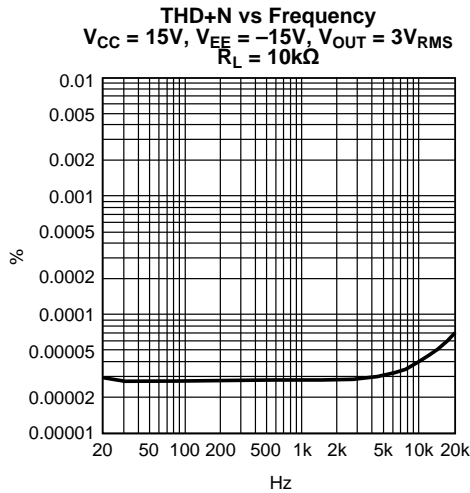


Figure 22.

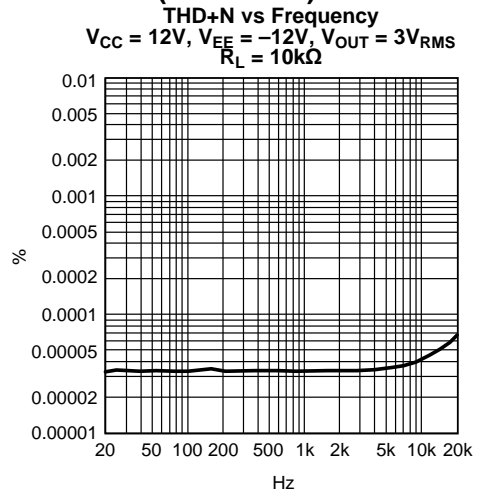


Figure 23.

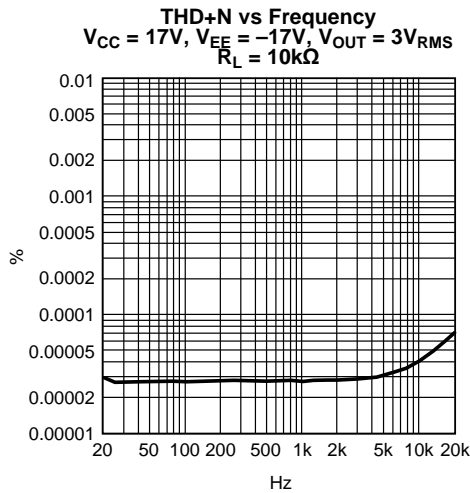


Figure 24.

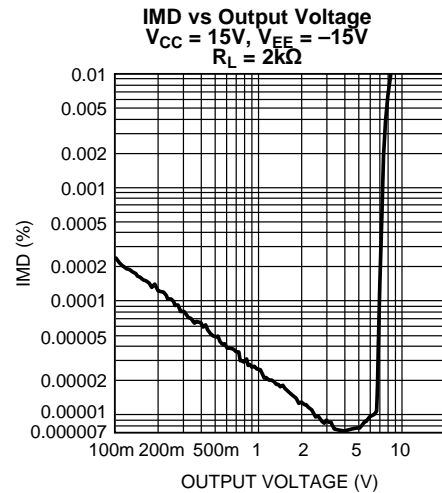


Figure 25.

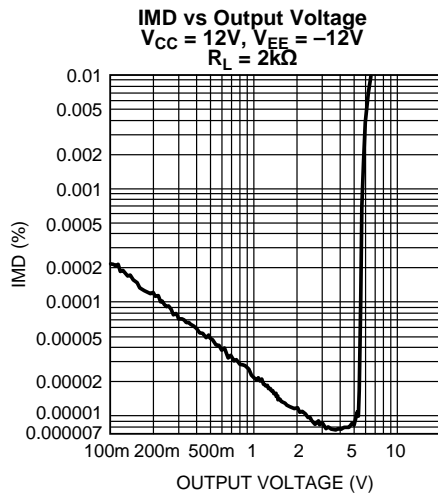


Figure 26.

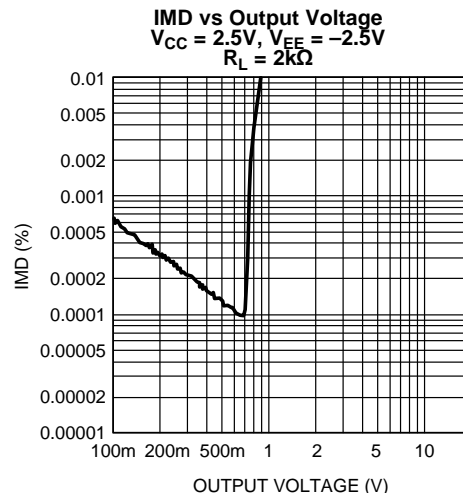


Figure 27.

**TYPICAL PERFORMANCE CHARACTERISTICS (continued)**

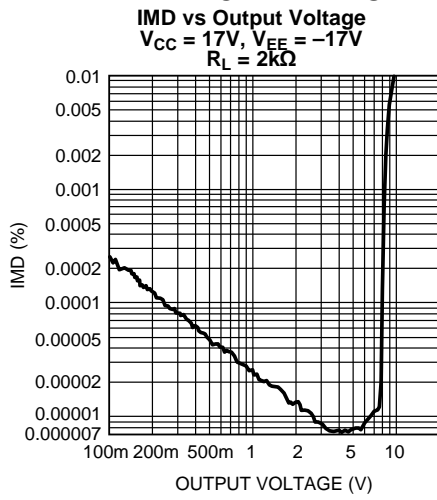


Figure 28.

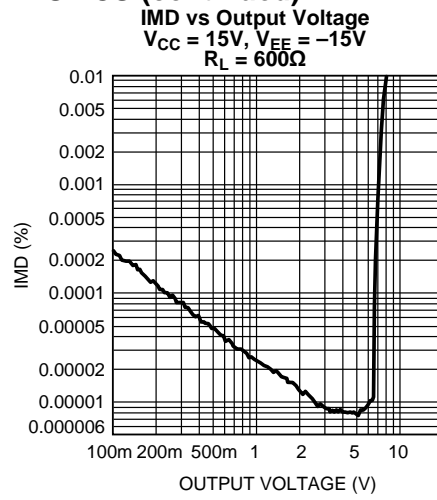


Figure 29.

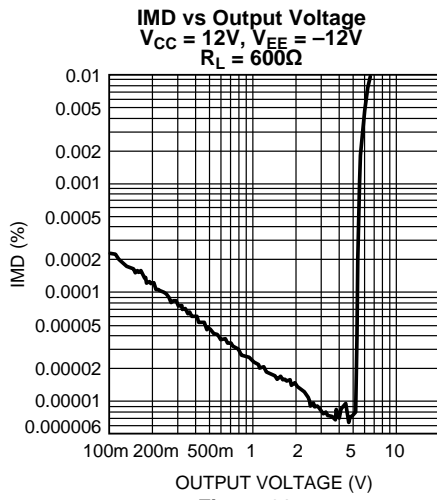


Figure 30.

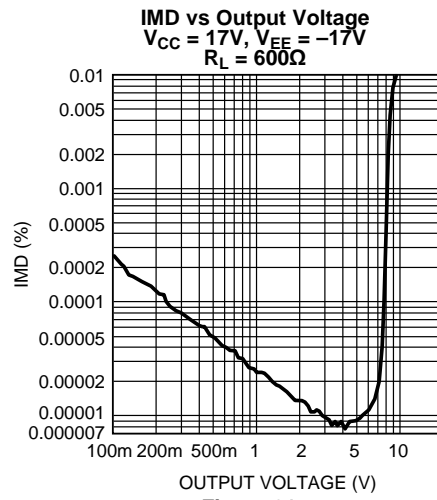


Figure 31.

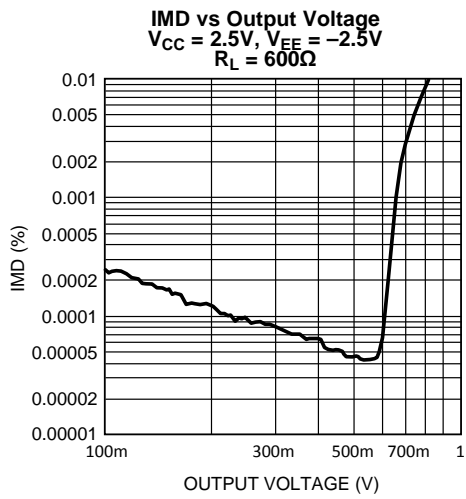


Figure 32.

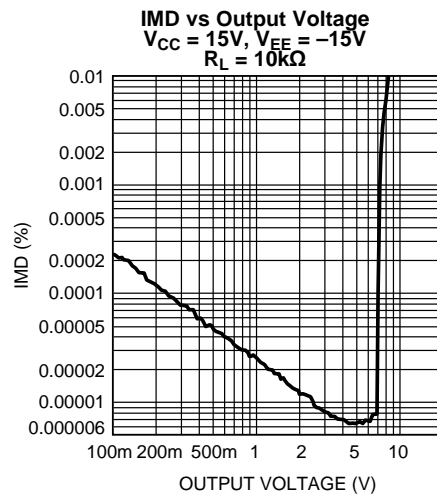


Figure 33.

**TYPICAL PERFORMANCE CHARACTERISTICS (continued)**

**IMD vs Output Voltage**  
 $V_{CC} = 12V, V_{EE} = -12V$   
 $R_L = 10k\Omega$

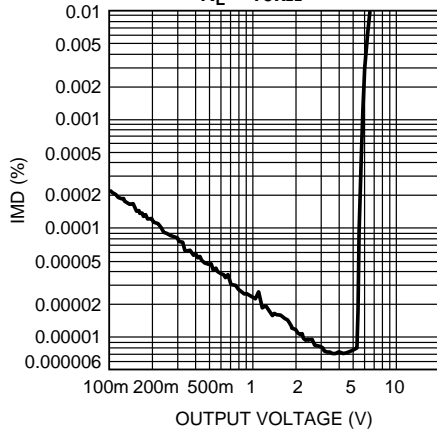


Figure 34.

**IMD vs Output Voltage**  
 $V_{CC} = 17V, V_{EE} = -17V$   
 $R_L = 10k\Omega$

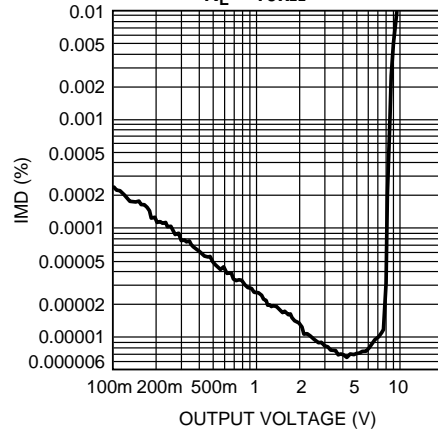


Figure 35.

**IMD vs Output Voltage**  
 $V_{CC} = 2.5V, V_{EE} = -2.5V$   
 $R_L = 10k\Omega$

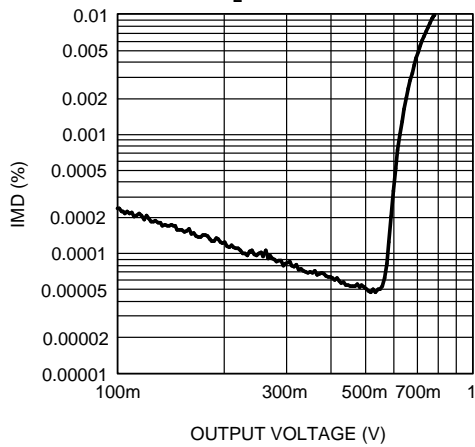


Figure 36.

**Voltage Noise Density vs Frequency**

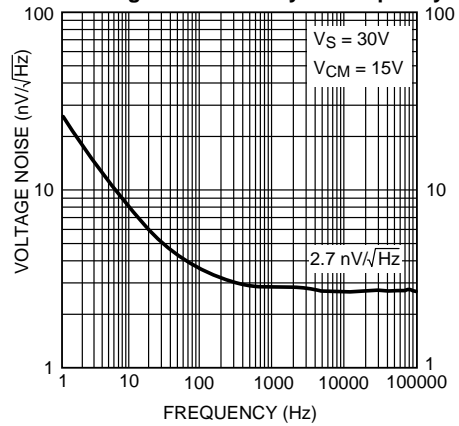


Figure 37.

**Current Noise Density vs Frequency**

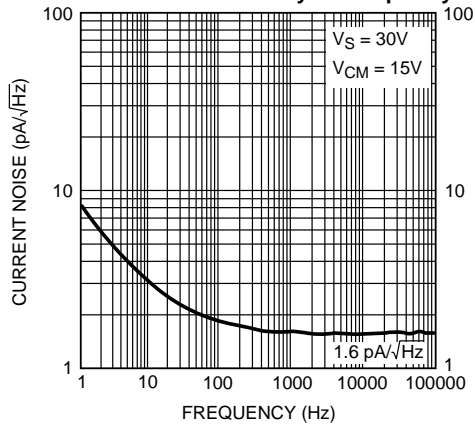


Figure 38.

**Crosstalk vs Frequency**  
 $V_{CC} = 15V, V_{EE} = -15V, V_{OUT} = 3V_{RMS}$   
 $A_V = 0dB, R_L = 2k\Omega$

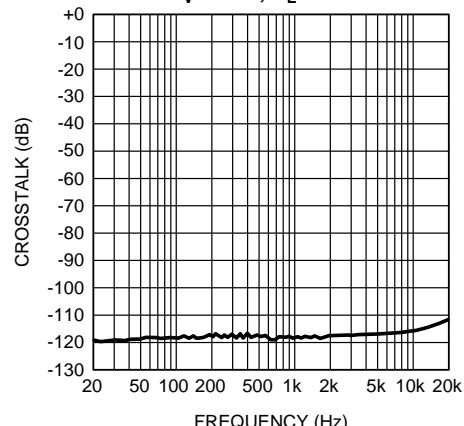


Figure 39.

**TYPICAL PERFORMANCE CHARACTERISTICS (continued)**

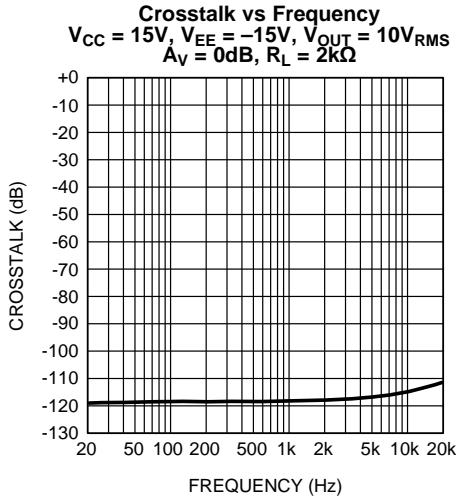


Figure 40.

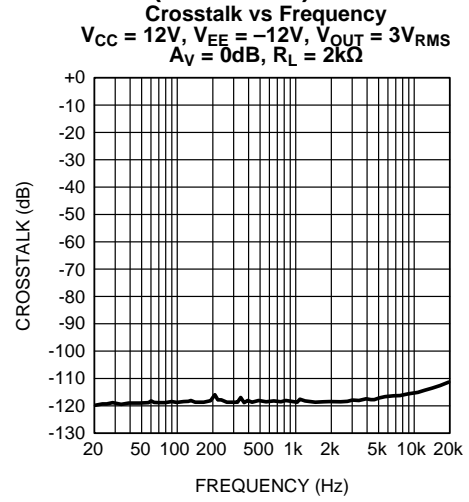


Figure 41.

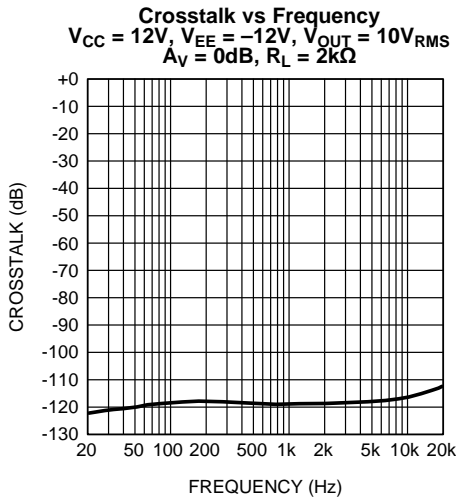


Figure 42.

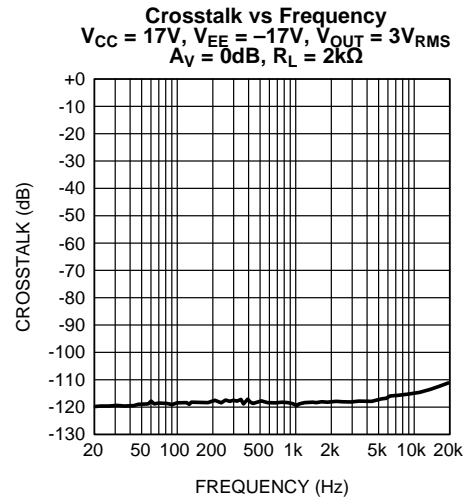


Figure 43.

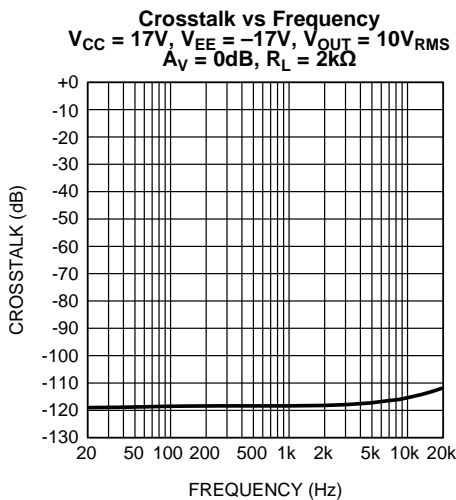


Figure 44.

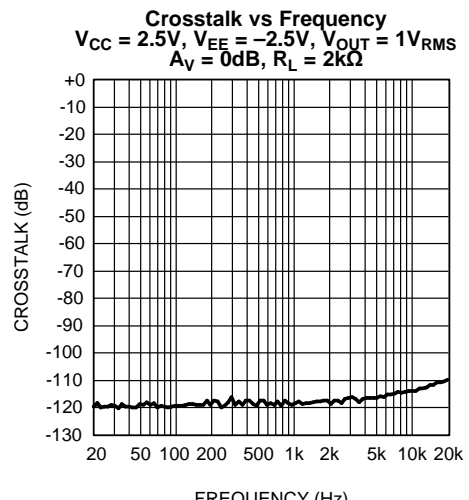


Figure 45.

**TYPICAL PERFORMANCE CHARACTERISTICS (continued)**

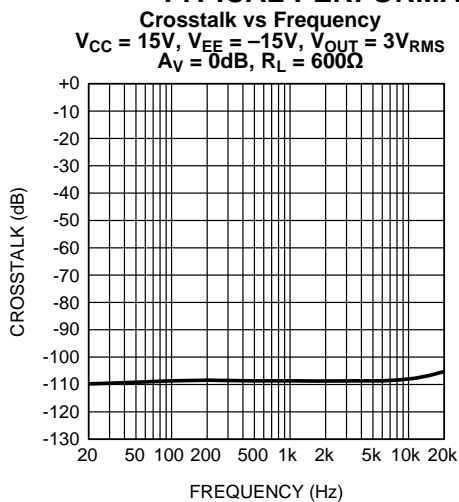


Figure 46.

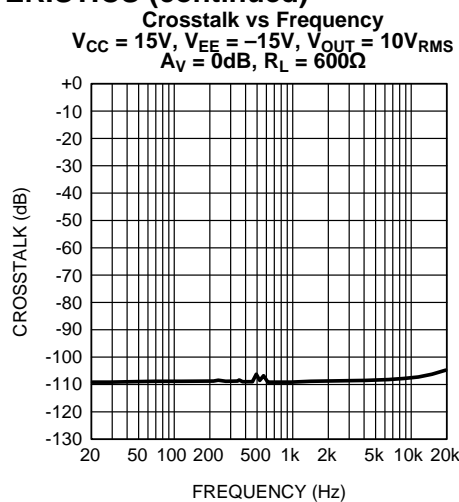


Figure 47.

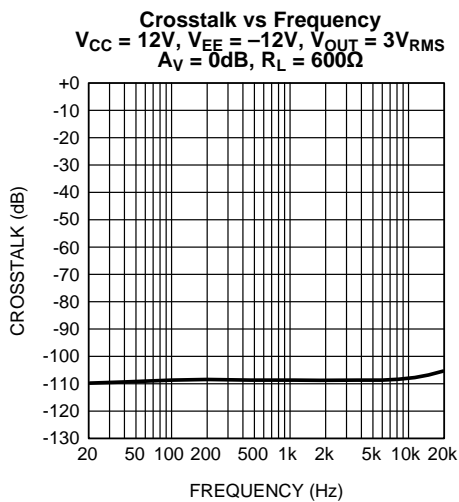


Figure 48.

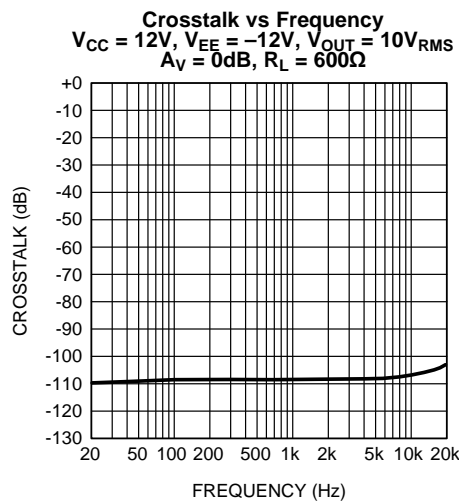


Figure 49.

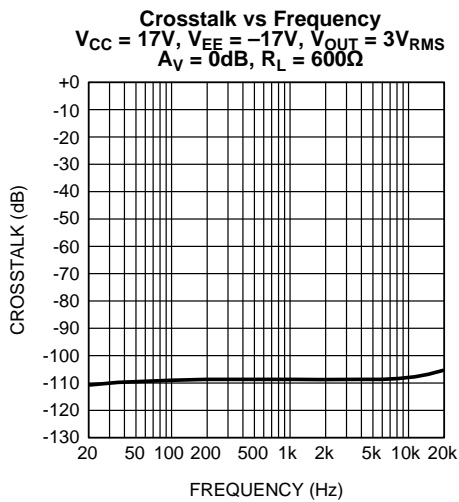


Figure 50.

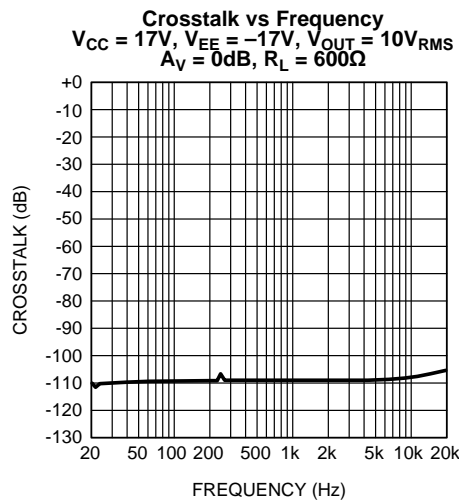


Figure 51.

**TYPICAL PERFORMANCE CHARACTERISTICS (continued)**

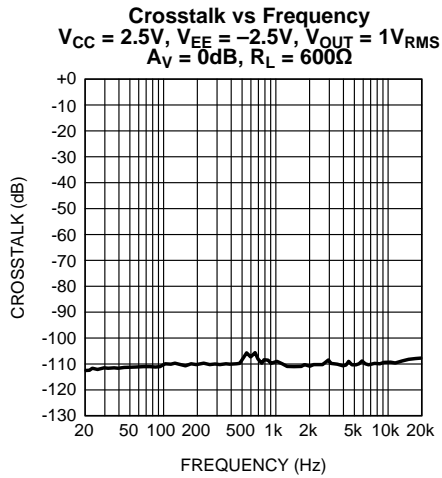


Figure 52.

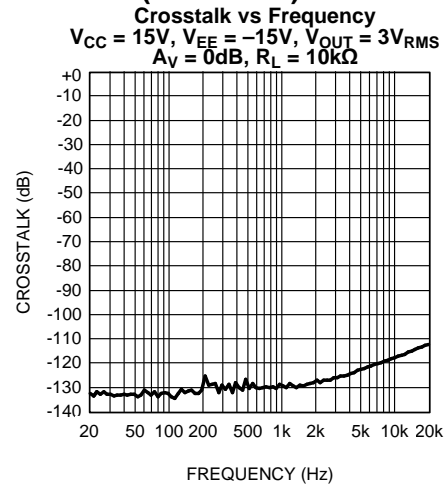


Figure 53.

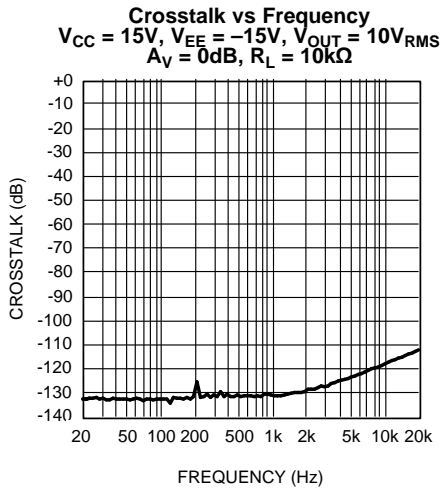


Figure 54.

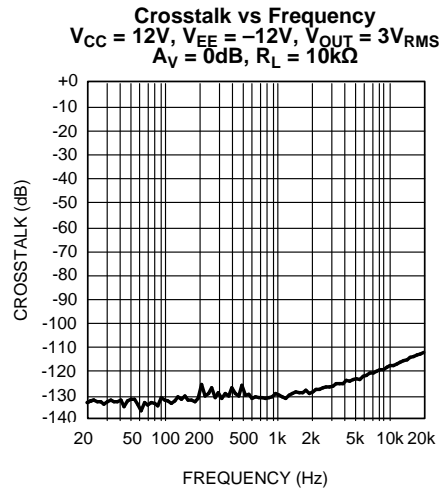


Figure 55.

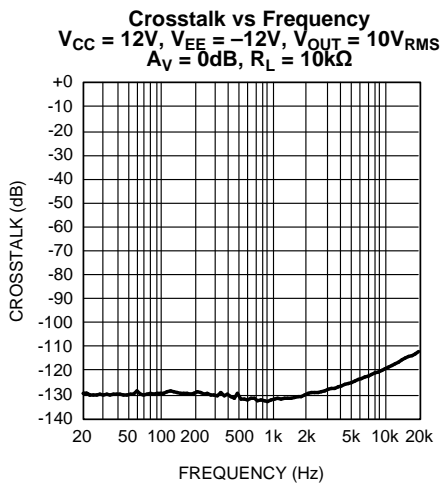


Figure 56.

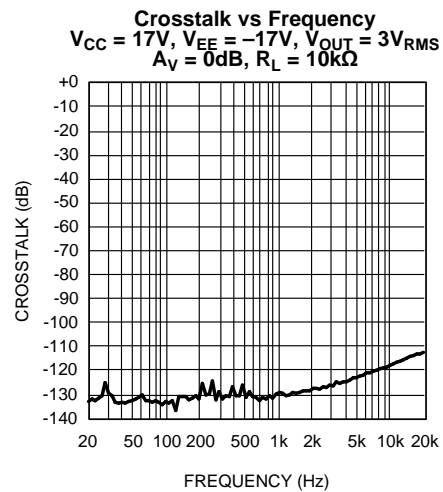


Figure 57.

**TYPICAL PERFORMANCE CHARACTERISTICS (continued)**

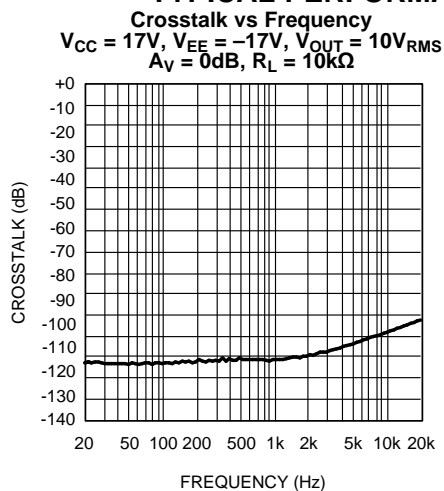


Figure 58.

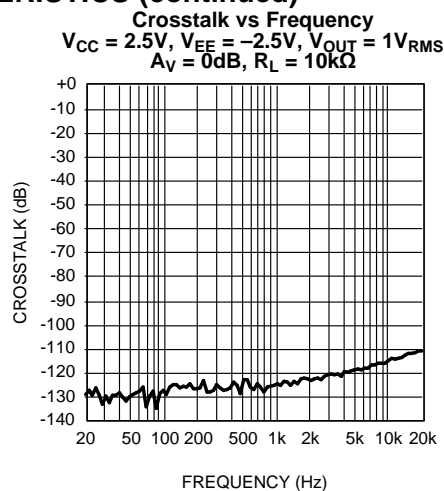


Figure 59.

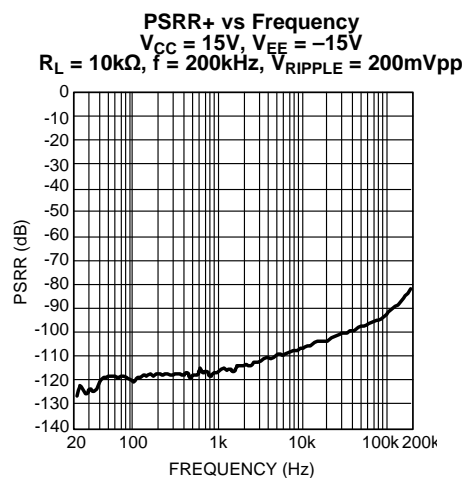


Figure 60.

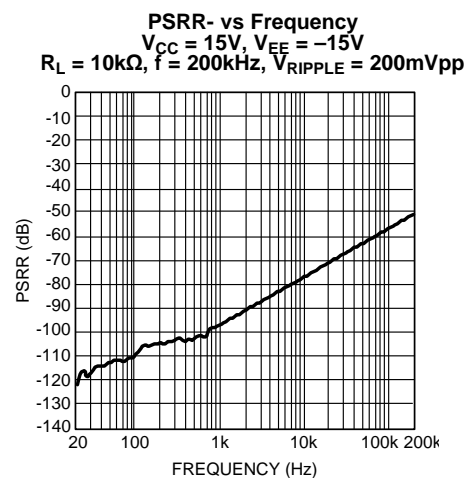


Figure 61.

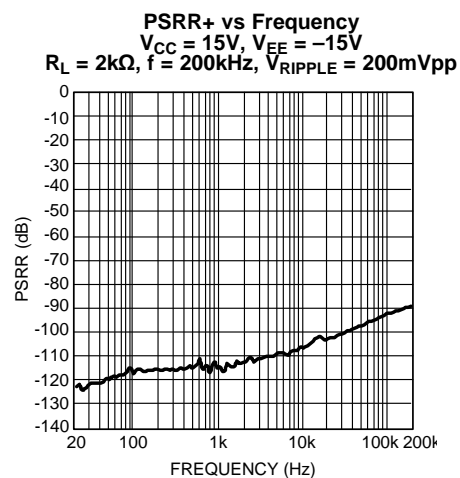


Figure 62.

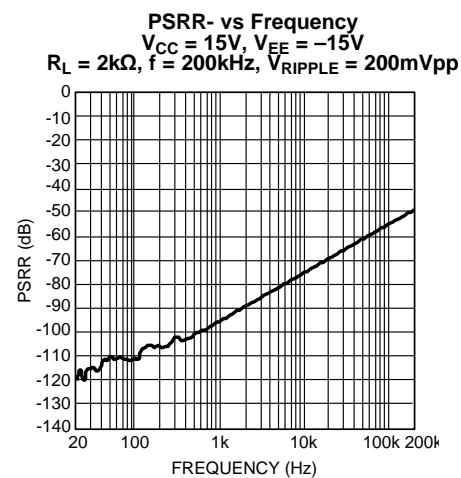


Figure 63.

**TYPICAL PERFORMANCE CHARACTERISTICS (continued)**

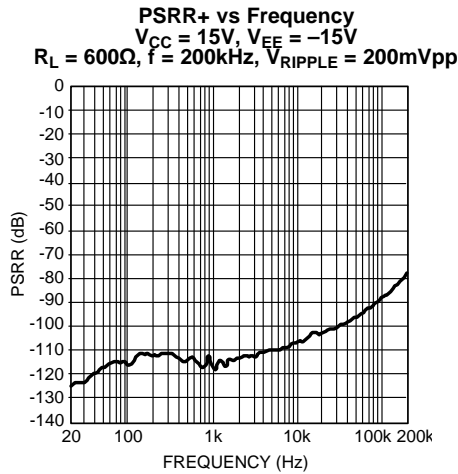


Figure 64.

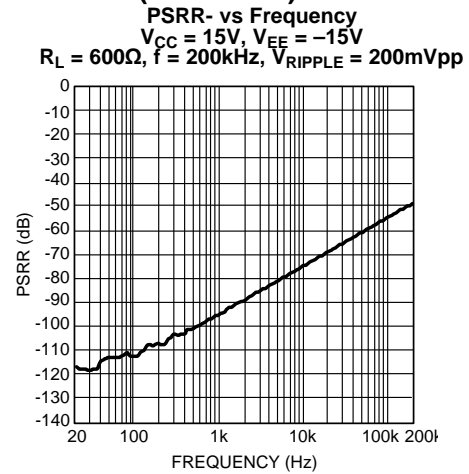


Figure 65.

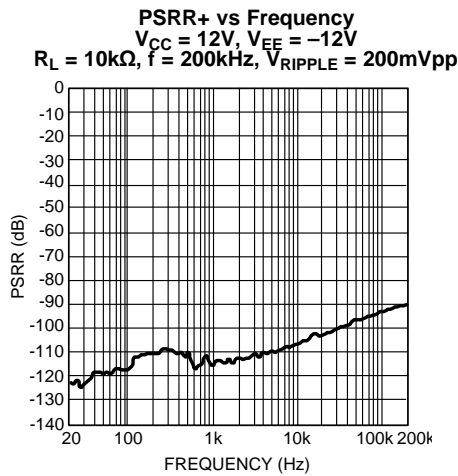


Figure 66.

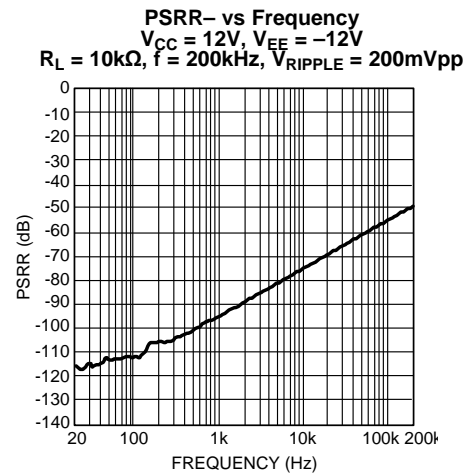


Figure 67.

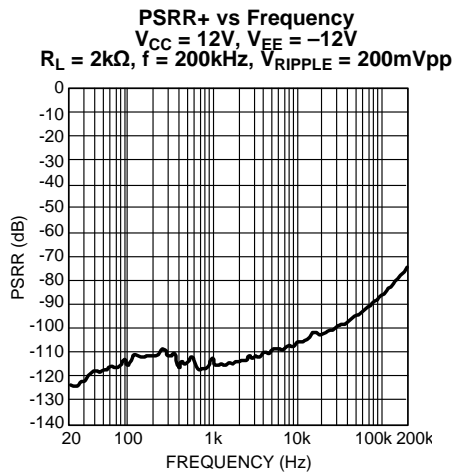


Figure 68.

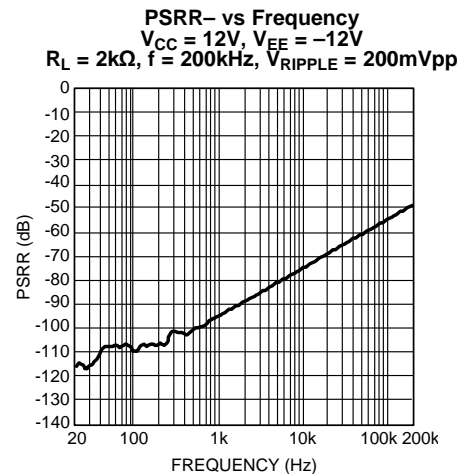


Figure 69.



**TYPICAL PERFORMANCE CHARACTERISTICS (continued)**

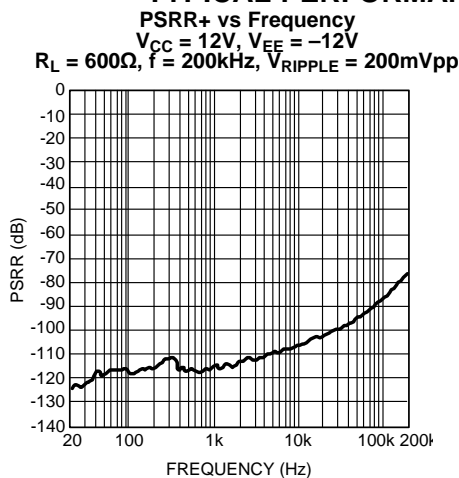


Figure 70.

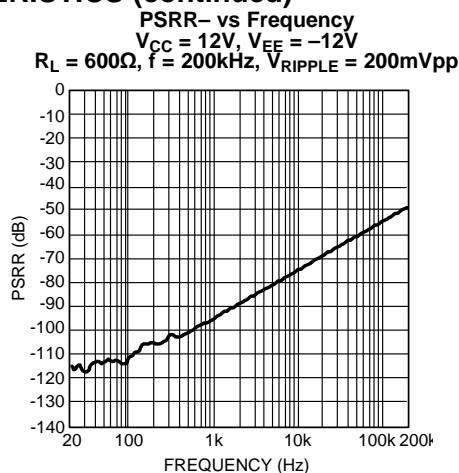


Figure 71.

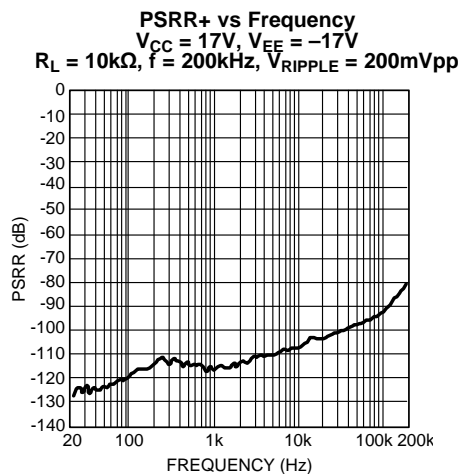


Figure 72.

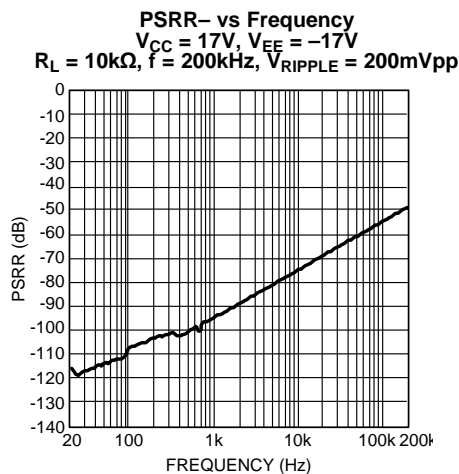


Figure 73.

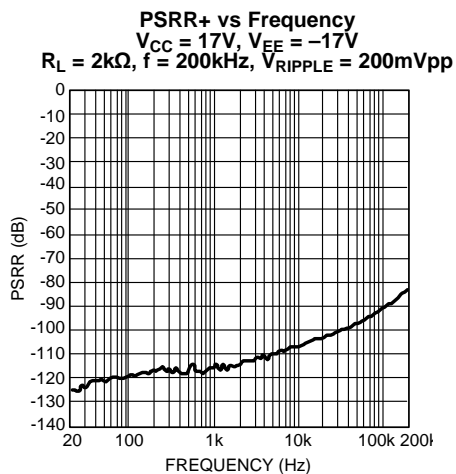


Figure 74.

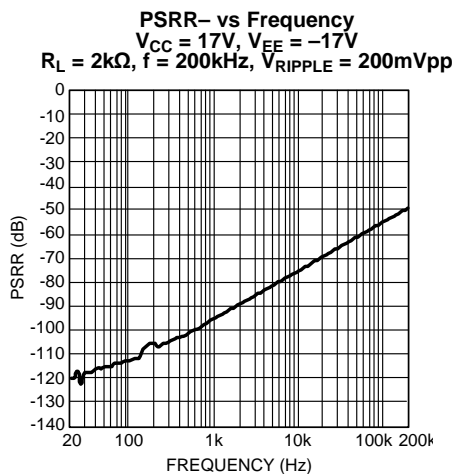


Figure 75.

**TYPICAL PERFORMANCE CHARACTERISTICS (continued)**

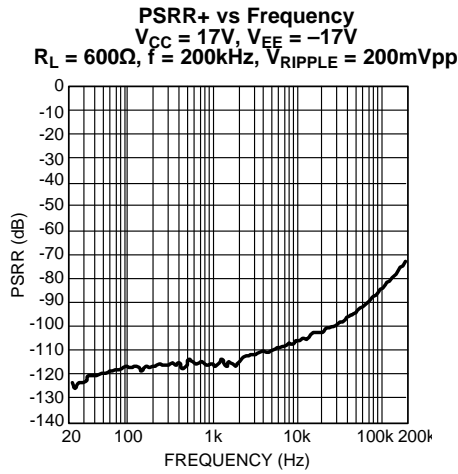


Figure 76.

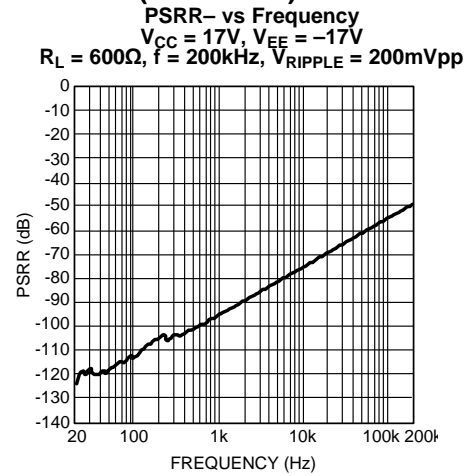


Figure 77.

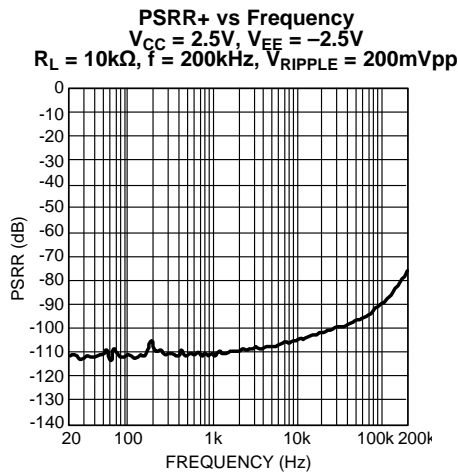


Figure 78.

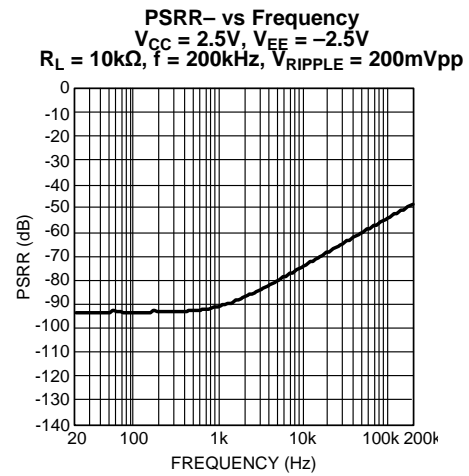


Figure 79.

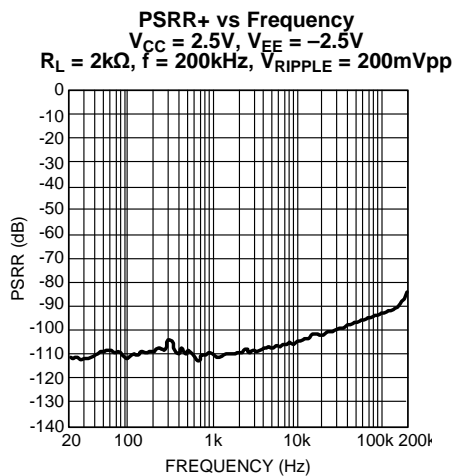


Figure 80.

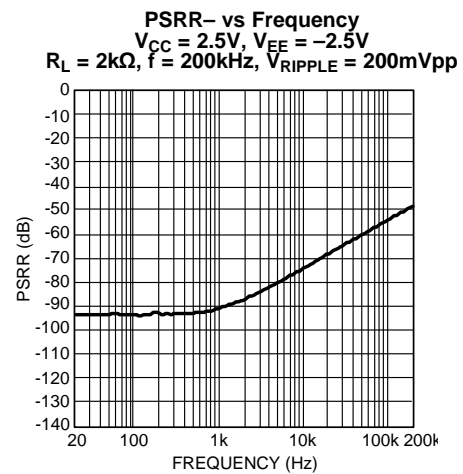


Figure 81.

**TYPICAL PERFORMANCE CHARACTERISTICS (continued)**

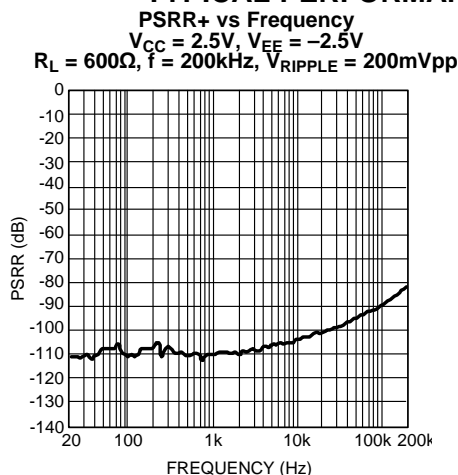


Figure 82.

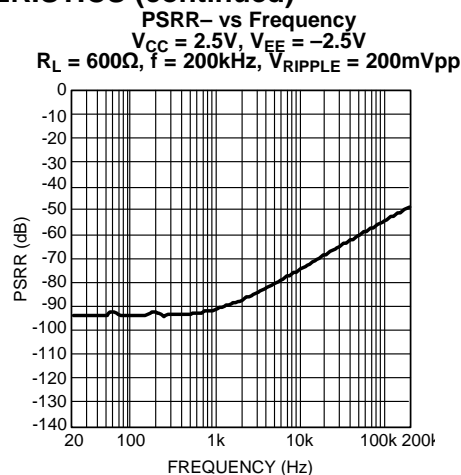


Figure 83.

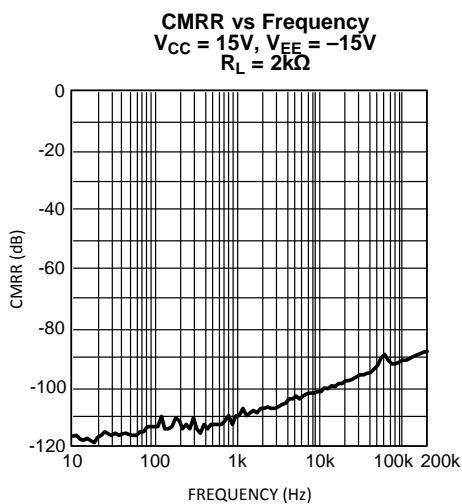


Figure 84.

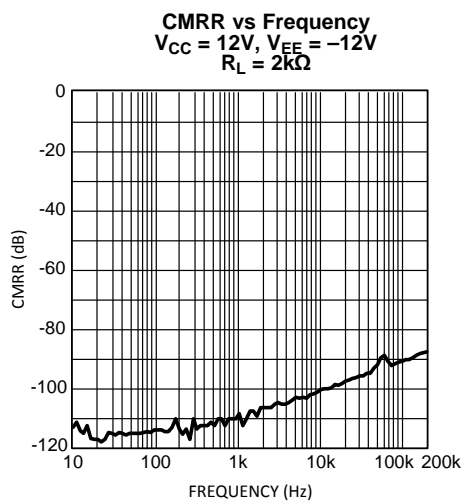


Figure 85.

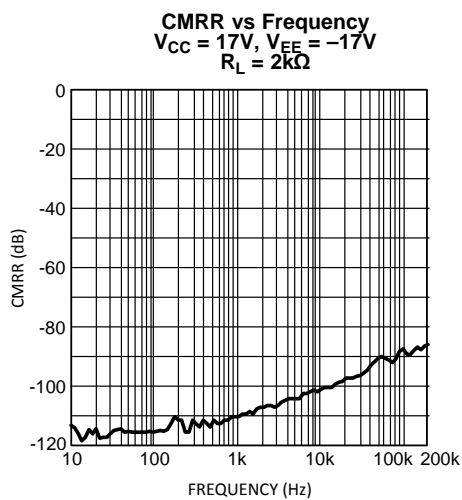


Figure 86.

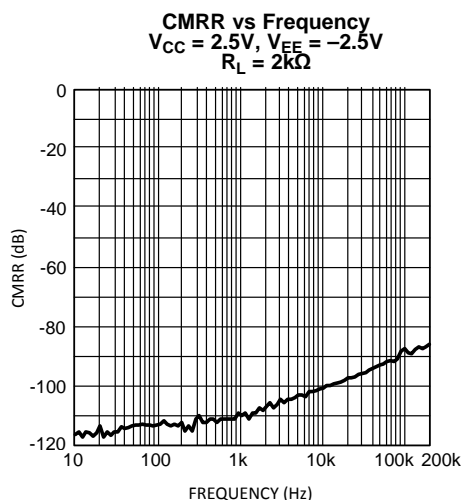


Figure 87.

**TYPICAL PERFORMANCE CHARACTERISTICS (continued)**

**CMRR vs Frequency**  
 $V_{CC} = 15V, V_{EE} = -15V$   
 $R_L = 600\Omega$

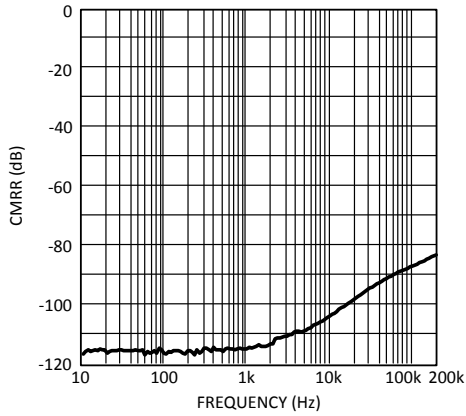


Figure 88.

**CMRR vs Frequency**  
 $V_{CC} = 12V, V_{EE} = -12V$   
 $R_L = 600\Omega$

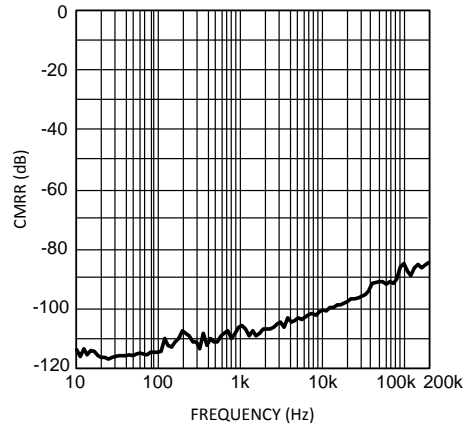


Figure 89.

**CMRR vs Frequency**  
 $V_{CC} = 17V, V_{EE} = -17V$   
 $R_L = 600\Omega$

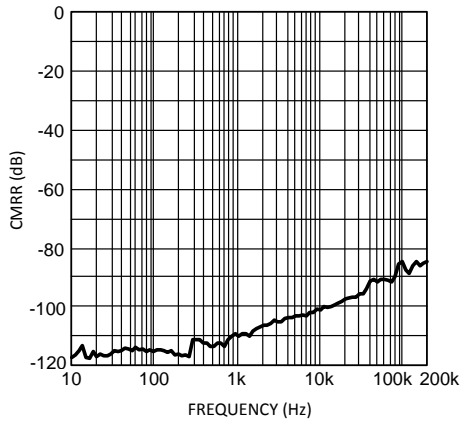


Figure 90.

**CMRR vs Frequency**  
 $V_{CC} = 2.5V, V_{EE} = -2.5V$   
 $R_L = 600\Omega$

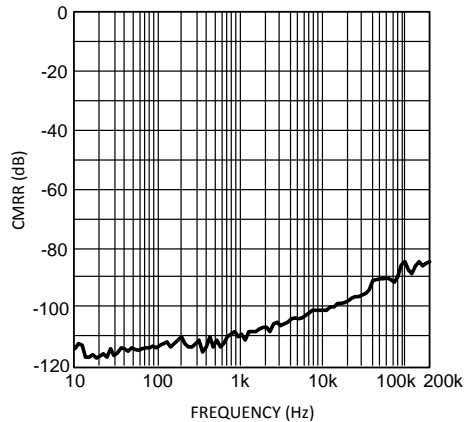


Figure 91.

**CMRR vs Frequency**  
 $V_{CC} = 15V, V_{EE} = -15V$   
 $R_L = 10k\Omega$

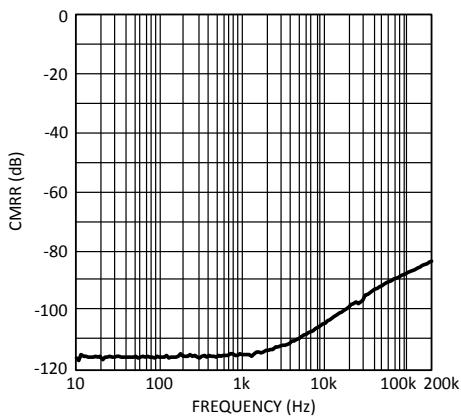


Figure 92.

**CMRR vs Frequency**  
 $V_{CC} = 12V, V_{EE} = -12V$   
 $R_L = 10k\Omega$

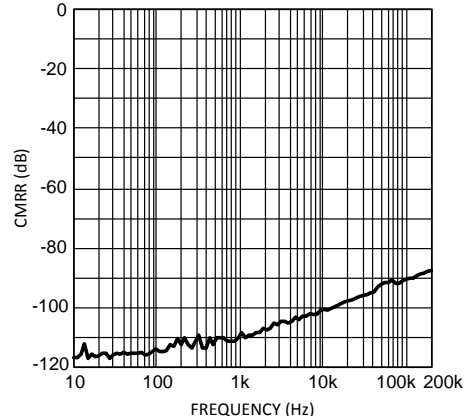


Figure 93.

**TYPICAL PERFORMANCE CHARACTERISTICS (continued)**

**CMRR vs Frequency**  
 $V_{CC} = 17V, V_{EE} = -17V$   
 $R_L = 10k\Omega$

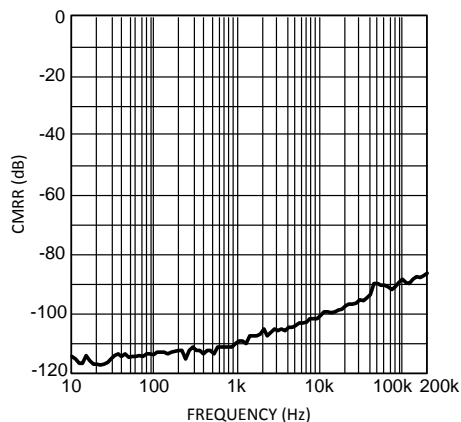


Figure 94.

**CMRR vs Frequency**  
 $V_{CC} = 2.5V, V_{EE} = -2.5V$   
 $R_L = 10k\Omega$

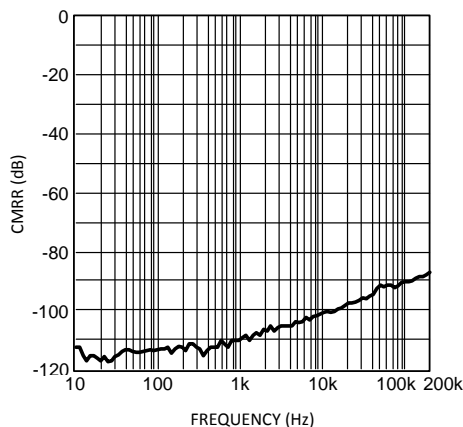


Figure 95.

**Output Voltage vs Load Resistance**  
 $V_{DD} = 15V, V_{EE} = -15V$   
 $THD+N = 1\%$

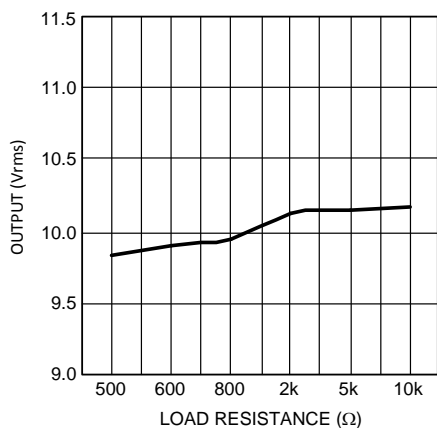


Figure 96.

**Output Voltage vs Load Resistance**  
 $V_{DD} = 12V, V_{EE} = -12V$   
 $THD+N = 1\%$

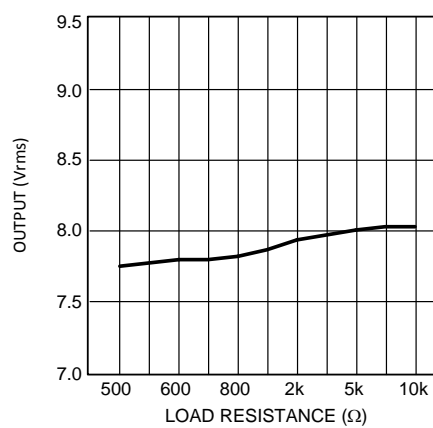


Figure 97.

**Output Voltage vs Load Resistance**  
 $V_{DD} = 17V, V_{EE} = -17V$   
 $THD+N = 1\%$

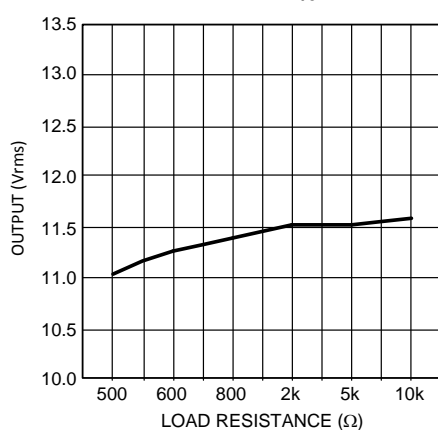


Figure 98.

**Output Voltage vs Load Resistance**  
 $V_{DD} = 2.5V, V_{EE} = -2.5V$   
 $THD+N = 1\%$

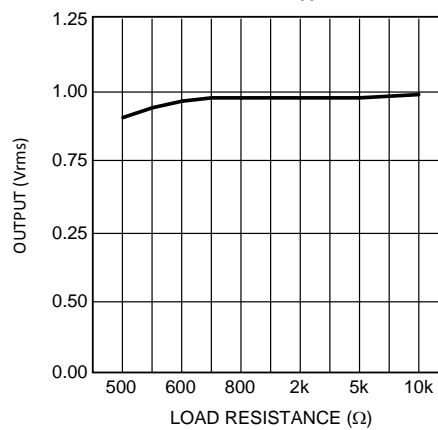


Figure 99.

**TYPICAL PERFORMANCE CHARACTERISTICS (continued)**

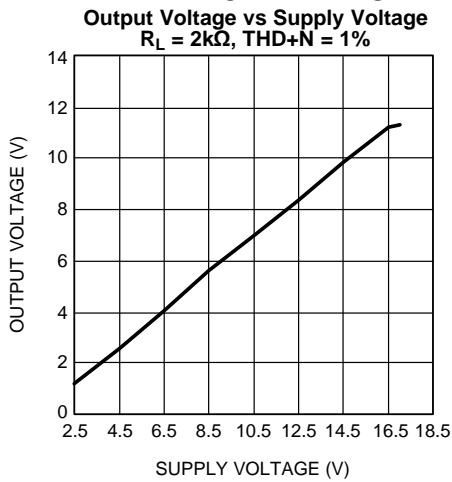


Figure 100.

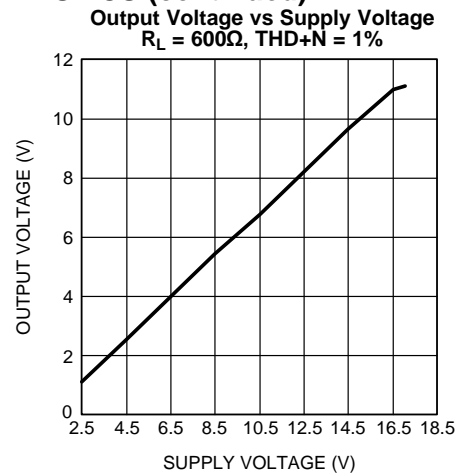


Figure 101.

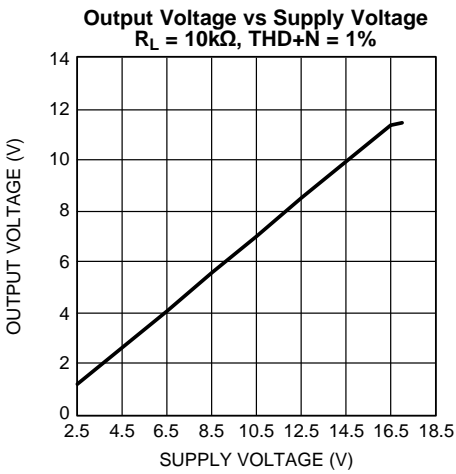


Figure 102.

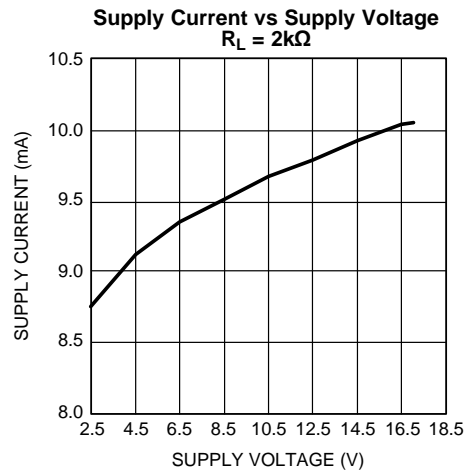


Figure 103.

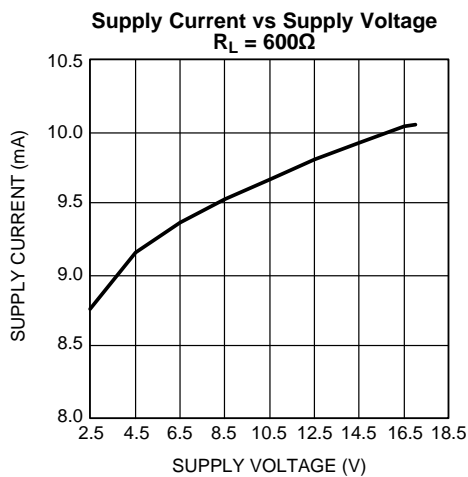


Figure 104.

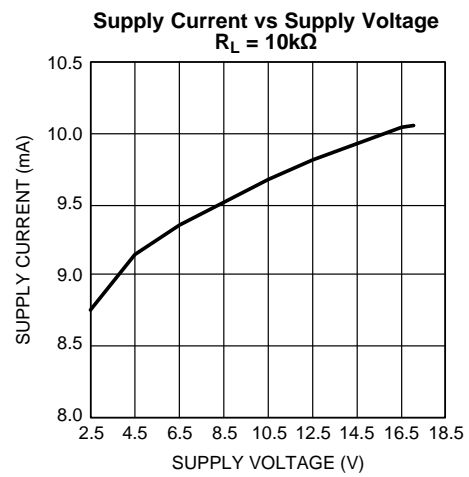


Figure 105.

TYPICAL PERFORMANCE CHARACTERISTICS (continued)

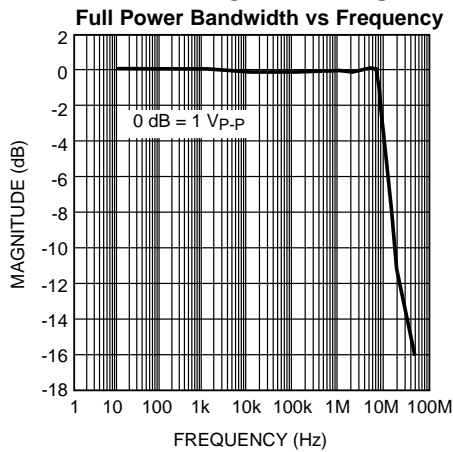


Figure 106.

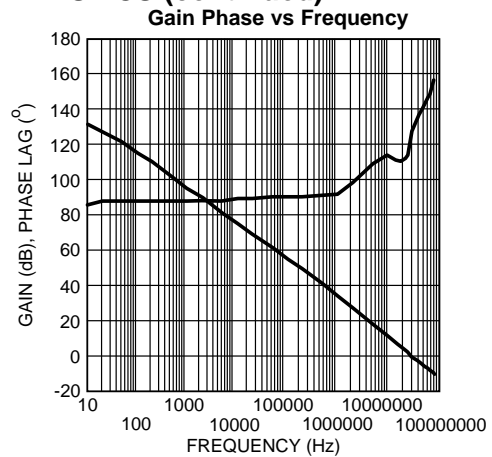


Figure 107.

Small-Signal Transient Response  
 $A_V = 1, C_L = 10\text{pF}$

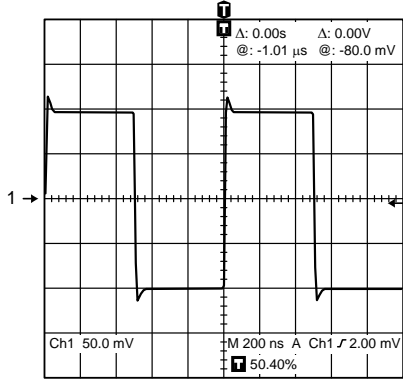


Figure 108.

Small-Signal Transient Response  
 $A_V = 1, C_L = 100\text{pF}$

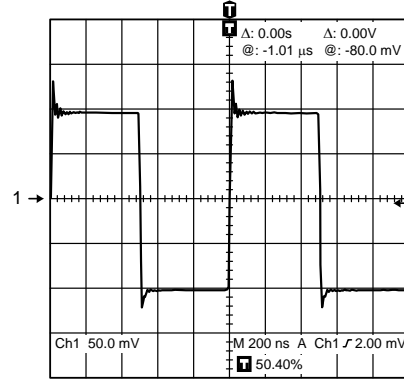


Figure 109.

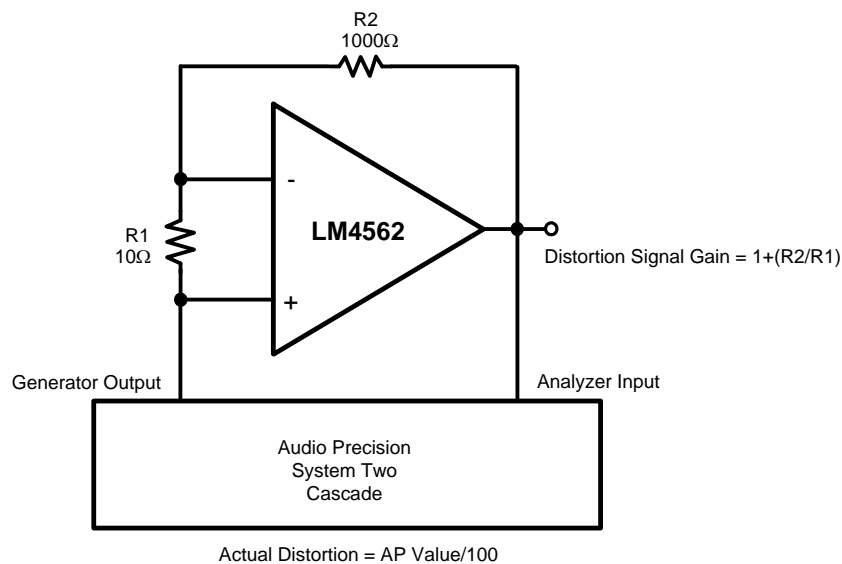
## APPLICATION INFORMATION

### DISTORTION MEASUREMENTS

The vanishingly low residual distortion produced by LM4562 is below the capabilities of all commercially available equipment. This makes distortion measurements just slightly more difficult than simply connecting a distortion meter to the amplifier's inputs and outputs. The solution, however, is quite simple: an additional resistor. Adding this resistor extends the resolution of the distortion measurement equipment.

The LM4562's low residual distortion is an input referred internal error. As shown in Figure 110, adding the 10Ω resistor connected between the amplifier's inverting and non-inverting inputs changes the amplifier's noise gain. The result is that the error signal (distortion) is amplified by a factor of 101. Although the amplifier's closed-loop gain is unaltered, the feedback available to correct distortion errors is reduced by 101, which means that measurement resolution increases by 101. To ensure minimum effects on distortion measurements, keep the value of R1 low as shown in Figure 110.

This technique is verified by duplicating the measurements with high closed loop gain and/or making the measurements at high frequencies. Doing so produces distortion components that are within the measurement equipment's capabilities. This datasheet's THD+N and IMD values were generated using the above described circuit connected to an Audio Precision System Two Cascade.

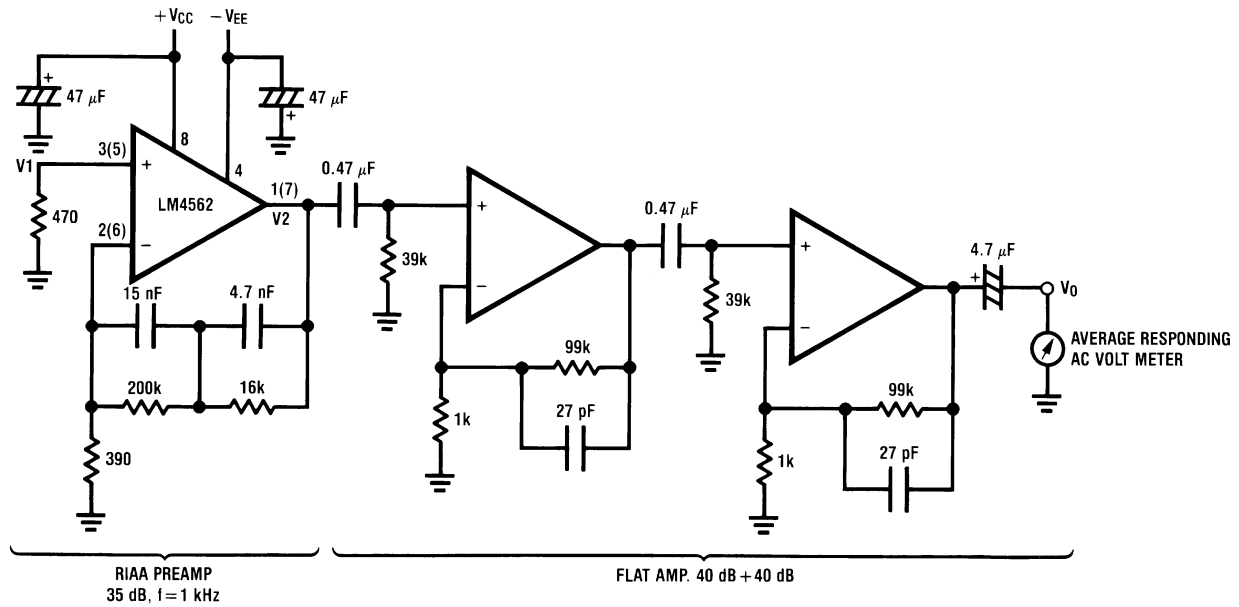


**Figure 110. THD+N and IMD Distortion Test Circuit**

The LM4562 is a high-speed op amp with excellent phase margin and stability. Capacitive loads up to 100pF will cause little change in the phase characteristics of the amplifiers and are therefore allowable.

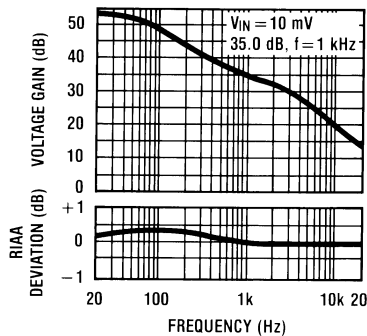
Capacitive loads greater than 100pF must be isolated from the output. The most straightforward way to do this is to put a resistor in series with the output. This resistor will also prevent excess power dissipation if the output is accidentally shorted.



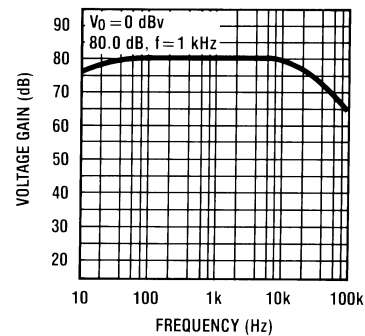


- A. Complete shielding is required to prevent induced pick up from external sources. Always check with oscilloscope for power line noise.

**Figure 111. Noise Measurement Circuit**  
**Total Gain: 115 dB @f = 1 kHz**  
**Input Referred Noise Voltage:  $e_n = V_0/560,000$  (V)**

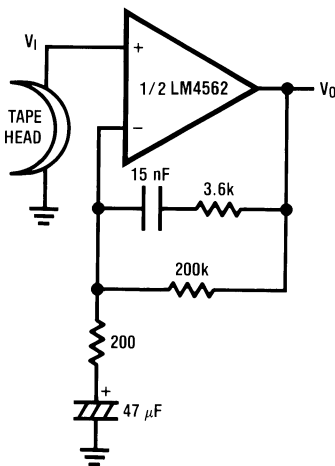


**Figure 112. RIAA Preamp Voltage Gain, RIAA Deviation vs Frequency**



**Figure 113. Flat Amp Voltage Gain vs Frequency**

TYPICAL APPLICATIONS



$A_v = 34.5$   
 $F = 1 \text{ kHz}$   
 $E_n = 0.38 \mu\text{V}$   
 A Weighted

Figure 114. NAB Preamp

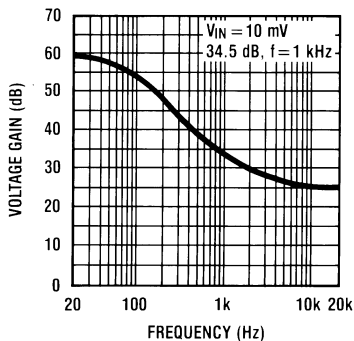
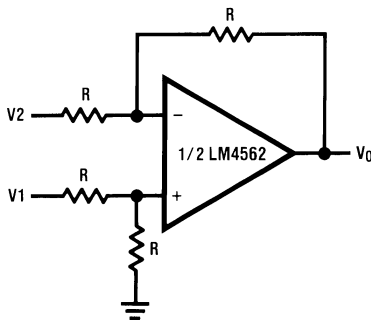
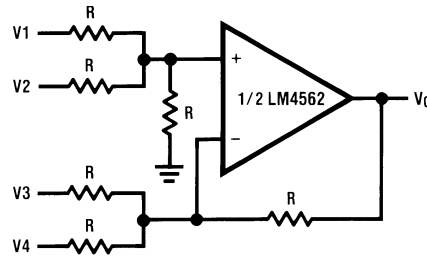


Figure 115. NAB Preamp Voltage Gain vs Frequency



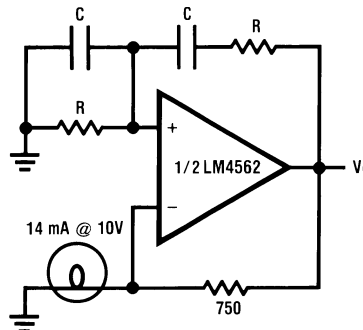
$V_o = V_1 - V_2$

Figure 116. Balanced to Single-Ended Converter



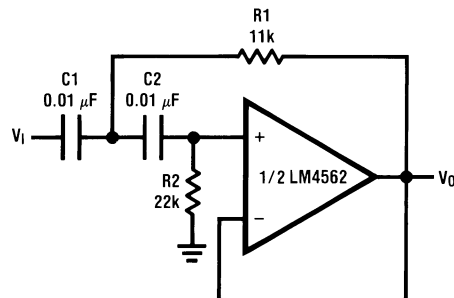
$$V_O = V_1 + V_2 - V_3 - V_4$$

Figure 117. Adder/Subtracter



$$f_o = \frac{1}{2\pi RC}$$

Figure 118. Sine Wave Oscillator



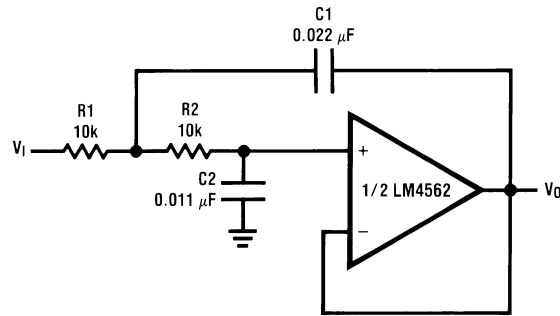
if  $C_1 = C_2 = C$

$$R_1 = \frac{\sqrt{2}}{2\omega_o C}$$

$$R_2 = 2 \cdot R_1$$

Illustration is  $f_o = 1 \text{ kHz}$

Figure 119. Second-Order High-Pass Filter (Butterworth)



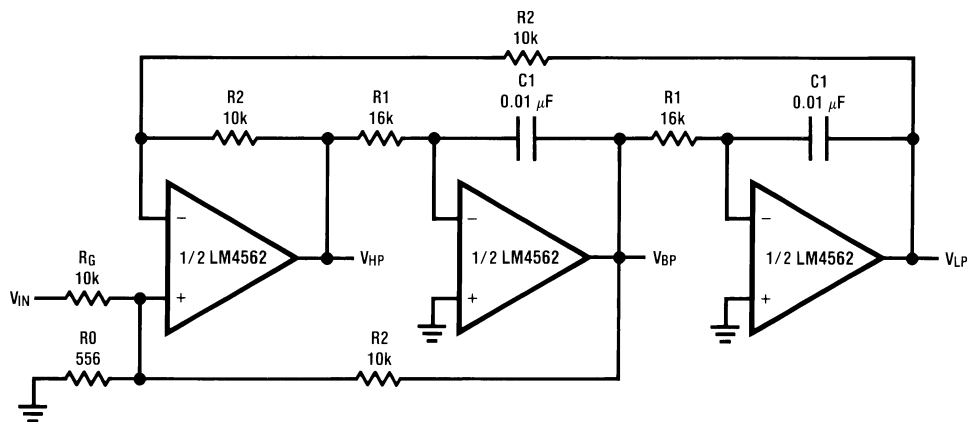
if  $R1 = R2 = R$

$$C1 = \frac{\sqrt{2}}{\omega_0 R}$$

$$C2 = \frac{C1}{2}$$

Illustration is  $f_0 = 1 \text{ kHz}$

Figure 120. Second-Order Low-Pass Filter (Butterworth)



$$f_0 = \frac{1}{2\pi C1 R1}, Q = \frac{1}{2} \left( 1 + \frac{R2}{R0} + \frac{R2}{RG} \right), A_{BP} = Q A_{LP} = Q A_{LH} = \frac{R2}{RG}$$

Illustration is  $f_0 = 1 \text{ kHz}, Q = 10, A_{BP} = 1$

Figure 121. State Variable Filter

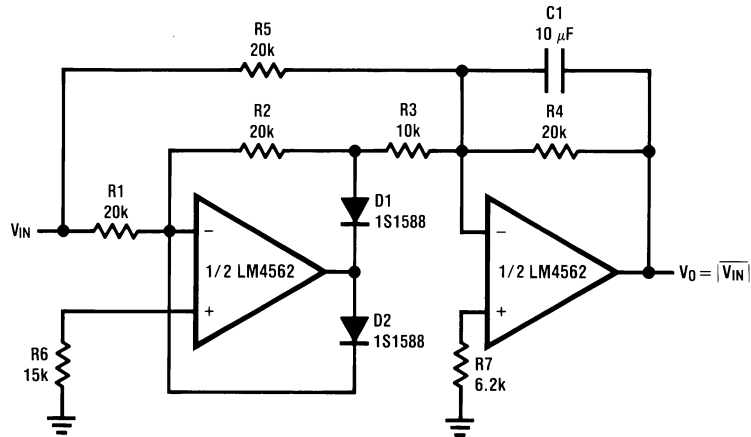


Figure 122. AC/DC Converter

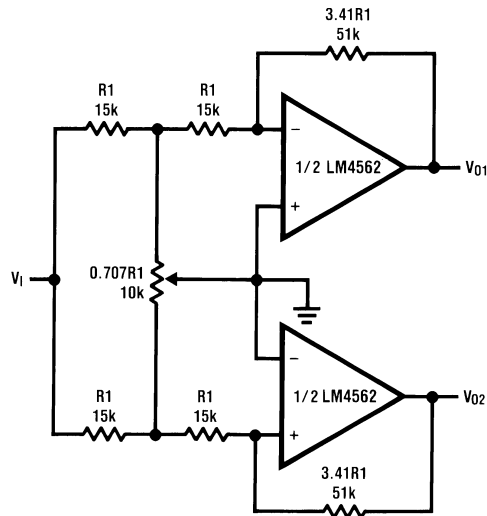


Figure 123. 2-Channel Panning Circuit (Pan Pot)

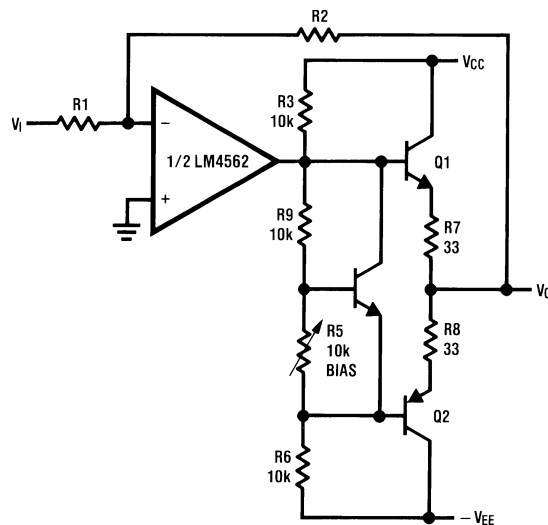
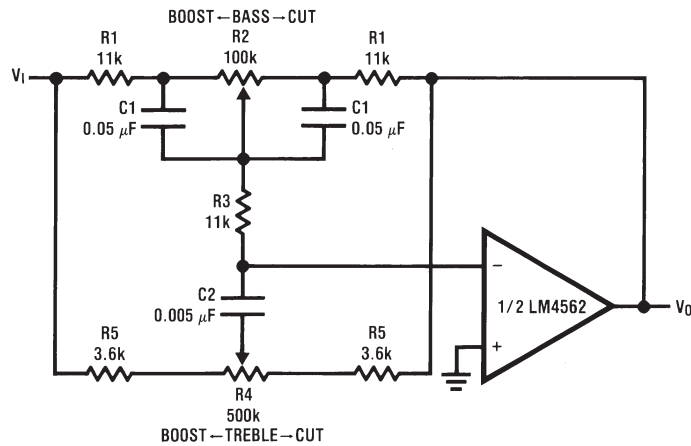


Figure 124. Line Driver



$$f_L \approx \frac{1}{2\pi R_2 C_1}, f_{LB} \approx \frac{1}{2\pi R_1 C_1}$$

$$f_H \approx \frac{1}{2\pi R_5 C_2}, f_{HB} \approx \frac{1}{2\pi (R_1 + R_5 + 2R_3) C_2}$$

The equations started above are simplifications, providing guidance of general -3dB point values, when the potentiometers are at their null position.

Illustration is:

$$f_L \approx 32 \text{ Hz}, f_{LB} \approx 320 \text{ Hz}$$

$$f_H \approx 11 \text{ kHz}, f_{HB} \approx 1.1 \text{ kHz}$$

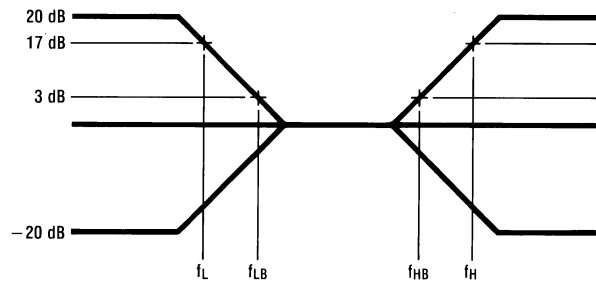
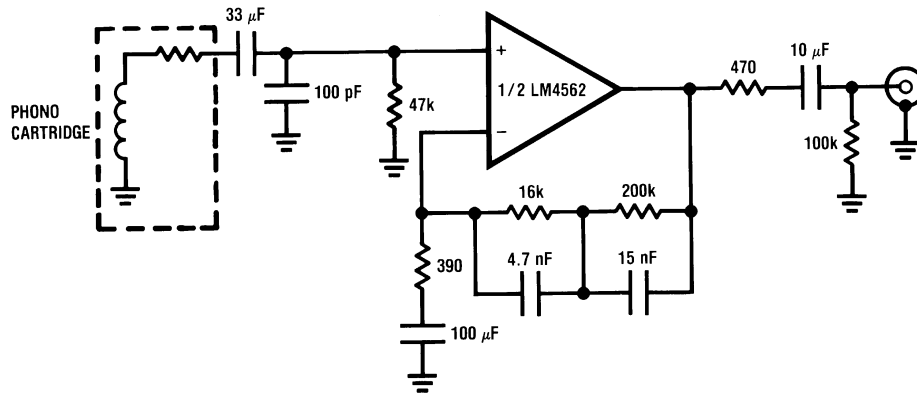
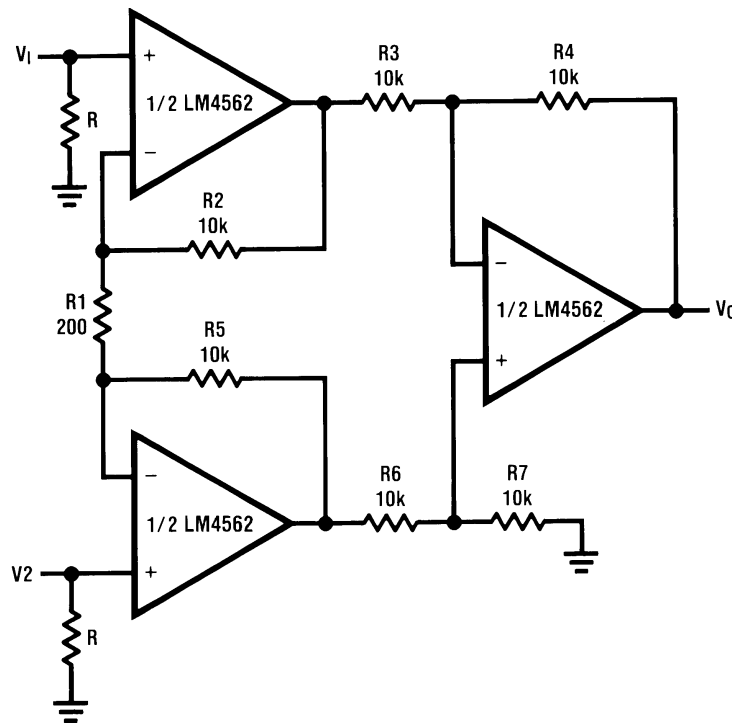


Figure 125. Tone Control



$A_v = 35 \text{ dB}$   
 $E_n = 0.33 \text{ } \mu\text{V S/N} = 90 \text{ dB}$   
 $f = 1 \text{ kHz}$   
 A Weighted  
 A Weighted,  $V_{IN} = 10 \text{ mV}$   
 @  $f = 1 \text{ kHz}$

Figure 126. RIAA Preamp



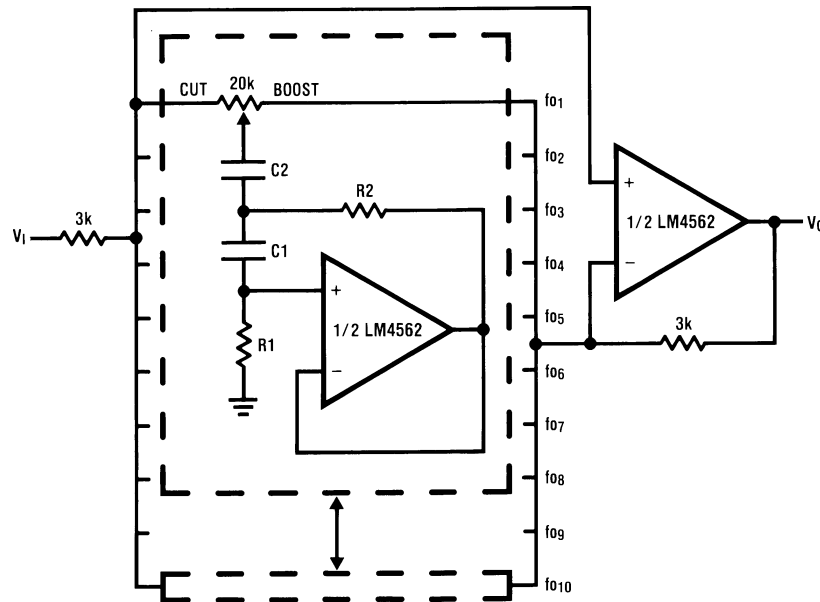
If  $R_2 = R_5$ ,  $R_3 = R_6$ ,  $R_4 = R_7$

$$V_0 = \left(1 + \frac{2R_2}{R_1}\right) \frac{R_4}{R_3} (V_2 - V_1)$$

Illustration is:

$$V_0 = 101(V_2 - V_1)$$

Figure 127. Balanced Input Mic Amp



A. See [Table 1](#).

**Figure 128. 10-Band Graphic Equalizer**

**Table 1.  $C_1$ ,  $C_2$ ,  $R_1$ , and  $R_2$  Values for [Figure 128](#)<sup>(1)</sup>**

$f_o$ (Hz)	$C_1$	$C_2$	$R_1$	$R_2$
32	0.12 $\mu$ F	4.7 $\mu$ F	75k $\Omega$	500 $\Omega$
64	0.056 $\mu$ F	3.3 $\mu$ F	68k $\Omega$	510 $\Omega$
125	0.033 $\mu$ F	1.5 $\mu$ F	62k $\Omega$	510 $\Omega$
250	0.015 $\mu$ F	0.82 $\mu$ F	68k $\Omega$	470 $\Omega$
500	8200pF	0.39 $\mu$ F	62k $\Omega$	470 $\Omega$
1k	3900pF	0.22 $\mu$ F	68k $\Omega$	470 $\Omega$
2k	2000pF	0.1 $\mu$ F	68k $\Omega$	470 $\Omega$
4k	1100pF	0.056 $\mu$ F	62k $\Omega$	470 $\Omega$
8k	510pF	0.022 $\mu$ F	68k $\Omega$	510 $\Omega$
16k	330pF	0.012 $\mu$ F	51k $\Omega$	510 $\Omega$

(1) At volume of change =  $\pm 12$  dB  $Q = 1.7$



### REVISION HISTORY

Rev	Date	Description
1.0	08/16/06	Initial release.
1.1	08/22/06	Updated the Instantaneous Short Circuit Current specification.
1.2	09/12/06	Updated the three $\pm 15\text{V}$ CMRR Typical Performance Curves.
1.3	09/26/06	Updated interstage filter capacitor values on page 1 Typical Application schematic.
1.4	05/03/07	Added the "general note" under the EC table.
1.5	10/17/07	Replaced all the PSRR curves.
1.6	01/26/10	Edited the equations on page 28 (under Tone Control).

**PACKAGING INFORMATION**

Orderable Device	Status (1)	Package Type	Package Drawing	Pins	Package Qty	Eco Plan (2)	Lead/Ball Finish	MSL Peak Temp (3)	Op Temp (°C)	Top-Side Markings (4)	Samples
LM4562HA/NOPB	ACTIVE	TO-99	LMC	8	20	Green (RoHS & no Sb/Br)	POST-PLATE	Level-1-NA-UNLIM	-40 to 85	LM4562HA	<a href="#">Samples</a>
LM4562MA/NOPB	ACTIVE	SOIC	D	8	95	Green (RoHS & no Sb/Br)	CU SN	Level-1-260C-UNLIM	-40 to 85	L4562 MA	<a href="#">Samples</a>
LM4562MAX/NOPB	ACTIVE	SOIC	D	8	2500	Green (RoHS & no Sb/Br)	CU SN	Level-1-260C-UNLIM	-40 to 85	L4562 MA	<a href="#">Samples</a>
LM4562NA/NOPB	ACTIVE	PDIP	P	8	40	Green (RoHS & no Sb/Br)	Call TI	Level-1-NA-UNLIM	-40 to 85	LM 4562NA	<a href="#">Samples</a>

(1) The marketing status values are defined as follows:

**ACTIVE:** Product device recommended for new designs.

**LIFEBUY:** TI has announced that the device will be discontinued, and a lifetime-buy period is in effect.

**NRND:** Not recommended for new designs. Device is in production to support existing customers, but TI does not recommend using this part in a new design.

**PREVIEW:** Device has been announced but is not in production. Samples may or may not be available.

**OBSOLETE:** TI has discontinued the production of the device.

(2) Eco Plan - The planned eco-friendly classification: Pb-Free (RoHS), Pb-Free (RoHS Exempt), or Green (RoHS & no Sb/Br) - please check <http://www.ti.com/productcontent> for the latest availability information and additional product content details.

**TBD:** The Pb-Free/Green conversion plan has not been defined.

**Pb-Free (RoHS):** TI's terms "Lead-Free" or "Pb-Free" mean semiconductor products that are compatible with the current RoHS requirements for all 6 substances, including the requirement that lead not exceed 0.1% by weight in homogeneous materials. Where designed to be soldered at high temperatures, TI Pb-Free products are suitable for use in specified lead-free processes.

**Pb-Free (RoHS Exempt):** This component has a RoHS exemption for either 1) lead-based flip-chip solder bumps used between the die and package, or 2) lead-based die adhesive used between the die and leadframe. The component is otherwise considered Pb-Free (RoHS compatible) as defined above.

**Green (RoHS & no Sb/Br):** TI defines "Green" to mean Pb-Free (RoHS compatible), and free of Bromine (Br) and Antimony (Sb) based flame retardants (Br or Sb do not exceed 0.1% by weight in homogeneous material)

(3) MSL, Peak Temp. -- The Moisture Sensitivity Level rating according to the JEDEC industry standard classifications, and peak solder temperature.

(4) Only one of markings shown within the brackets will appear on the physical device.

**Important Information and Disclaimer:** The information provided on this page represents TI's knowledge and belief as of the date that it is provided. TI bases its knowledge and belief on information provided by third parties, and makes no representation or warranty as to the accuracy of such information. Efforts are underway to better integrate information from third parties. TI has taken and continues to take reasonable steps to provide representative and accurate information but may not have conducted destructive testing or chemical analysis on incoming materials and chemicals. TI and TI suppliers consider certain information to be proprietary, and thus CAS numbers and other limited information may not be available for release.

In no event shall TI's liability arising out of such information exceed the total purchase price of the TI part(s) at issue in this document sold by TI to Customer on an annual basis.



## TAPE AND REEL INFORMATION



### QUADRANT ASSIGNMENTS FOR PIN 1 ORIENTATION IN TAPE



\*All dimensions are nominal

Device	Package Type	Package Drawing	Pins	SPQ	Reel Diameter (mm)	Reel Width W1 (mm)	A0 (mm)	B0 (mm)	K0 (mm)	P1 (mm)	W (mm)	Pin1 Quadrant
LM4562MAX/NOPB	SOIC	D	8	2500	330.0	12.4	6.5	5.4	2.0	8.0	12.0	Q1

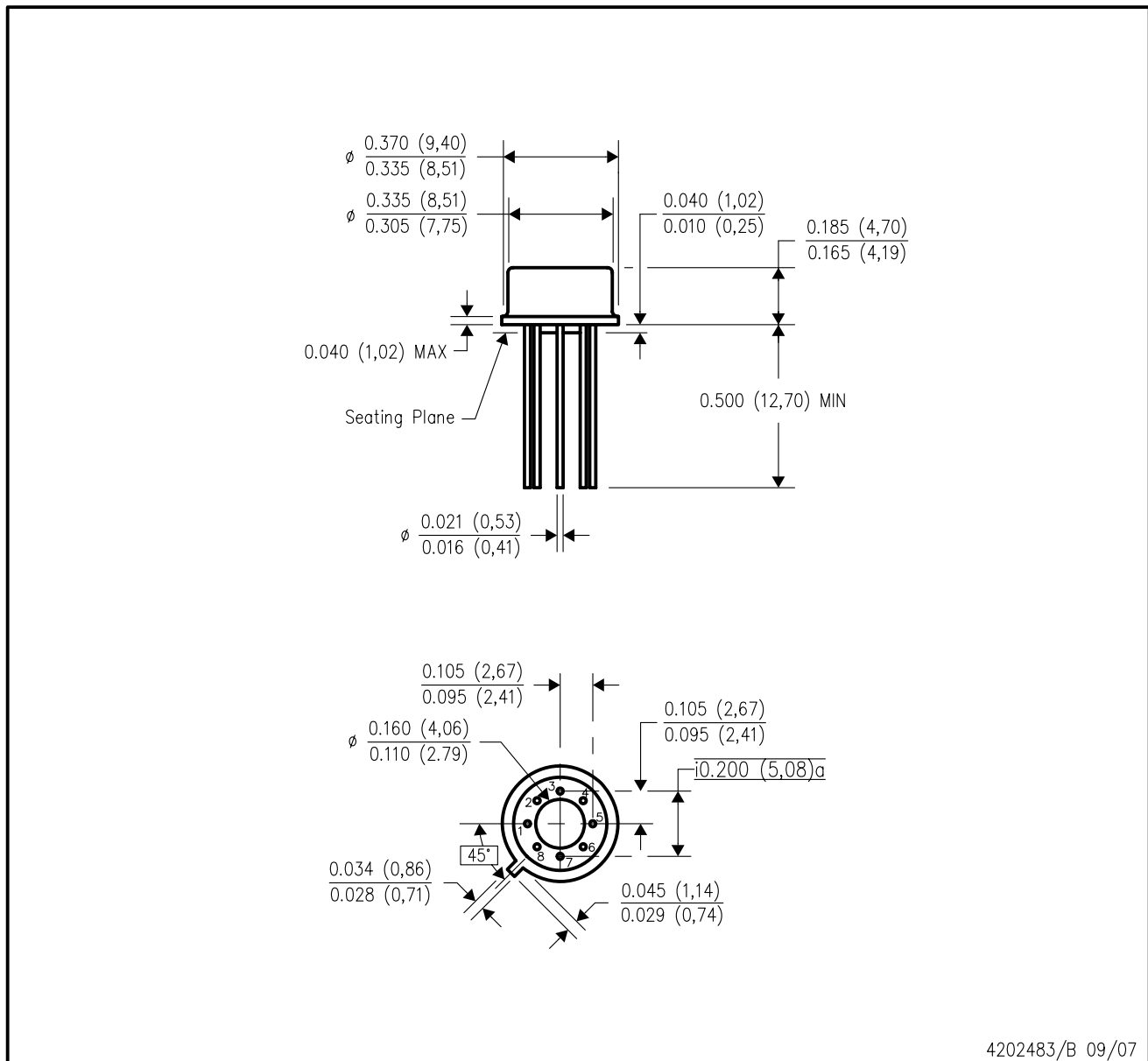
**TAPE AND REEL BOX DIMENSIONS**


\*All dimensions are nominal

Device	Package Type	Package Drawing	Pins	SPQ	Length (mm)	Width (mm)	Height (mm)
LM4562MAX/NOPB	SOIC	D	8	2500	367.0	367.0	35.0

## LMC (O-MBCY-W8)

## METAL CYLINDRICAL PACKAGE



- NOTES:
- All linear dimensions are in inches (millimeters).
  - This drawing is subject to change without notice.
  - Leads in true position within  $0.010$  (0,25) R @ MMC at seating plane.
  - Pin numbers shown for reference only. Numbers may not be marked on package.
  - Falls within JEDEC MO-002/TO-99.

P (R-PDIP-T8)

PLASTIC DUAL-IN-LINE PACKAGE



- NOTES:
- A. All linear dimensions are in inches (millimeters).
  - B. This drawing is subject to change without notice.
  - C. Falls within JEDEC MS-001 variation BA.

D (R-PDSO-G8)

PLASTIC SMALL OUTLINE



NOTES: A. All linear dimensions are in inches (millimeters).  
 B. This drawing is subject to change without notice.  
 C. Body length does not include mold flash, protrusions, or gate burrs. Mold flash, protrusions, or gate burrs shall not exceed 0.006 (0,15) each side.  
 D. Body width does not include interlead flash. Interlead flash shall not exceed 0.017 (0,43) each side.  
 E. Reference JEDEC MS-012 variation AA.



## IMPORTANT NOTICE

Texas Instruments Incorporated and its subsidiaries (TI) reserve the right to make corrections, enhancements, improvements and other changes to its semiconductor products and services per JESD46, latest issue, and to discontinue any product or service per JESD48, latest issue. Buyers should obtain the latest relevant information before placing orders and should verify that such information is current and complete. All semiconductor products (also referred to herein as "components") are sold subject to TI's terms and conditions of sale supplied at the time of order acknowledgment.

TI warrants performance of its components to the specifications applicable at the time of sale, in accordance with the warranty in TI's terms and conditions of sale of semiconductor products. Testing and other quality control techniques are used to the extent TI deems necessary to support this warranty. Except where mandated by applicable law, testing of all parameters of each component is not necessarily performed.

TI assumes no liability for applications assistance or the design of Buyers' products. Buyers are responsible for their products and applications using TI components. To minimize the risks associated with Buyers' products and applications, Buyers should provide adequate design and operating safeguards.

TI does not warrant or represent that any license, either express or implied, is granted under any patent right, copyright, mask work right, or other intellectual property right relating to any combination, machine, or process in which TI components or services are used. Information published by TI regarding third-party products or services does not constitute a license to use such products or services or a warranty or endorsement thereof. Use of such information may require a license from a third party under the patents or other intellectual property of the third party, or a license from TI under the patents or other intellectual property of TI.

Reproduction of significant portions of TI information in TI data books or data sheets is permissible only if reproduction is without alteration and is accompanied by all associated warranties, conditions, limitations, and notices. TI is not responsible or liable for such altered documentation. Information of third parties may be subject to additional restrictions.

Resale of TI components or services with statements different from or beyond the parameters stated by TI for that component or service voids all express and any implied warranties for the associated TI component or service and is an unfair and deceptive business practice. TI is not responsible or liable for any such statements.

Buyer acknowledges and agrees that it is solely responsible for compliance with all legal, regulatory and safety-related requirements concerning its products, and any use of TI components in its applications, notwithstanding any applications-related information or support that may be provided by TI. Buyer represents and agrees that it has all the necessary expertise to create and implement safeguards which anticipate dangerous consequences of failures, monitor failures and their consequences, lessen the likelihood of failures that might cause harm and take appropriate remedial actions. Buyer will fully indemnify TI and its representatives against any damages arising out of the use of any TI components in safety-critical applications.

In some cases, TI components may be promoted specifically to facilitate safety-related applications. With such components, TI's goal is to help enable customers to design and create their own end-product solutions that meet applicable functional safety standards and requirements. Nonetheless, such components are subject to these terms.

No TI components are authorized for use in FDA Class III (or similar life-critical medical equipment) unless authorized officers of the parties have executed a special agreement specifically governing such use.

Only those TI components which TI has specifically designated as military grade or "enhanced plastic" are designed and intended for use in military/aerospace applications or environments. Buyer acknowledges and agrees that any military or aerospace use of TI components which have **not** been so designated is solely at the Buyer's risk, and that Buyer is solely responsible for compliance with all legal and regulatory requirements in connection with such use.

TI has specifically designated certain components as meeting ISO/TS16949 requirements, mainly for automotive use. In any case of use of non-designated products, TI will not be responsible for any failure to meet ISO/TS16949.

### Products

Audio	<a href="http://www.ti.com/audio">www.ti.com/audio</a>
Amplifiers	<a href="http://amplifier.ti.com">amplifier.ti.com</a>
Data Converters	<a href="http://dataconverter.ti.com">dataconverter.ti.com</a>
DLP® Products	<a href="http://www.dlp.com">www.dlp.com</a>
DSP	<a href="http://dsp.ti.com">dsp.ti.com</a>
Clocks and Timers	<a href="http://www.ti.com/clocks">www.ti.com/clocks</a>
Interface	<a href="http://interface.ti.com">interface.ti.com</a>
Logic	<a href="http://logic.ti.com">logic.ti.com</a>
Power Mgmt	<a href="http://power.ti.com">power.ti.com</a>
Microcontrollers	<a href="http://microcontroller.ti.com">microcontroller.ti.com</a>
RFID	<a href="http://www.ti-rfid.com">www.ti-rfid.com</a>
OMAP Applications Processors	<a href="http://www.ti.com/omap">www.ti.com/omap</a>
Wireless Connectivity	<a href="http://www.ti.com/wirelessconnectivity">www.ti.com/wirelessconnectivity</a>

### Applications

Automotive and Transportation	<a href="http://www.ti.com/automotive">www.ti.com/automotive</a>
Communications and Telecom	<a href="http://www.ti.com/communications">www.ti.com/communications</a>
Computers and Peripherals	<a href="http://www.ti.com/computers">www.ti.com/computers</a>
Consumer Electronics	<a href="http://www.ti.com/consumer-apps">www.ti.com/consumer-apps</a>
Energy and Lighting	<a href="http://www.ti.com/energy">www.ti.com/energy</a>
Industrial	<a href="http://www.ti.com/industrial">www.ti.com/industrial</a>
Medical	<a href="http://www.ti.com/medical">www.ti.com/medical</a>
Security	<a href="http://www.ti.com/security">www.ti.com/security</a>
Space, Avionics and Defense	<a href="http://www.ti.com/space-avionics-defense">www.ti.com/space-avionics-defense</a>
Video and Imaging	<a href="http://www.ti.com/video">www.ti.com/video</a>

### TI E2E Community

[e2e.ti.com](http://e2e.ti.com)

# Mouser Electronics

Authorized Distributor

Click to View Pricing, Inventory, Delivery & Lifecycle Information:

[Texas Instruments:](#)

[LM4562HABD](#) [LM4562MABD](#)