



2SD669/A

NPN SILICON TRANSISTOR

BIPOLAR POWER GENERAL PURPOSE TRANSISTOR

■ APPLICATIONS

* Low frequency power amplifier complementary pair with UTC 2SB649/A

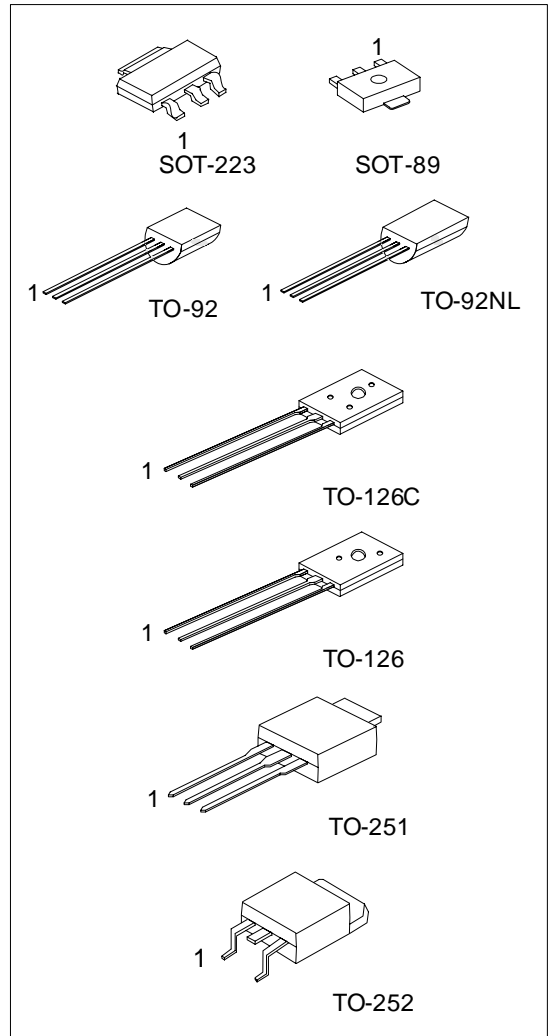

*Pb-free plating product number:
2SD669L/2SD669AL

■ ORDERING INFORMATION

| Order Number | | Package | Pin Assignment | | | Packing |
|----------------|-------------------|---------|----------------|---|---|-----------|
| Normal | Lead Free Plating | | 1 | 2 | 3 | |
| 2SD669-x-AA3-R | 2SD669L-x-AA3-R | SOT-223 | B | C | E | Tape Reel |
| 2SD669-x-AB3-R | 2SD669L-x-AB3-R | SOT-89 | B | C | E | Tape Reel |
| 2SD669-x-T60-K | 2SD669L-x-T60-K | TO-126 | E | C | B | Bulk |
| 2SD669-x-T6C-R | 2SD669L-x-T6C-R | TO-126C | E | C | B | Bulk |
| 2SD669-x-T92-B | 2SD669L-x-T92-B | TO-92 | E | C | B | Tape Box |
| 2SD669-x-T92-K | 2SD669L-x-T92-K | TO-92 | E | C | B | Bulk |
| 2SD669-x-T9N-B | 2SD669L-x-T9N-B | TO-92NL | E | C | B | Tape Box |
| 2SD669-x-T9N-K | 2SD669L-x-T9N-K | TO-92NL | E | C | B | Bulk |
| 2SD669-x-T9N-R | 2SD669L-x-T9N-R | TO-92NL | E | C | B | Tape Reel |
| 2SD669-x-TM3-T | 2SD669L-x-TM3-T | TO-251 | E | C | B | Tube |
| 2SD669-x-TN3-R | 2SD669L-x-TN3-R | TO-252 | B | C | E | Tape Reel |
| 2SD669-x-TN3-T | 2SD669L-x-TN3-T | TO-252 | B | C | E | Tube |

■ ORDERING INFORMATION(Cont.)

| Order Number | | Package | Pin Assignment | | | Packing |
|-----------------|-------------------|---------|----------------|---|---|-----------|
| Normal | Lead Free Plating | | 1 | 2 | 3 | |
| 2SD669A-x-AA3-R | 2SD669AL-x-AA3-R | SOT-223 | B | C | E | Tape Reel |
| 2SD669A-x-AB3-R | 2SD669AL-x-AB3-R | SOT-89 | B | C | E | Tape Reel |
| 2SD669A-x-T60-K | 2SD669AL-x-T60-K | TO-126 | E | C | B | Bulk |
| 2SD669A-x-T6C-R | 2SD669AL-x-T6C-R | TO-126C | E | C | B | Bulk |
| 2SD669A-x-T92-B | 2SD669AL-x-T92-B | TO-92 | E | C | B | Tape Box |
| 2SD669A-x-T92-K | 2SD669AL-x-T92-K | TO-92 | E | C | B | Bulk |
| 2SD669A-x-T9N-B | 2SD669AL-x-T9N-B | TO-92NL | E | C | B | Tape Box |
| 2SD669A-x-T9N-K | 2SD669AL-x-T9N-K | TO-92NL | E | C | B | Bulk |
| 2SD669A-x-T9N-R | 2SD669AL-x-T9N-R | TO-92NL | E | C | B | Tape Reel |
| 2SD669A-x-TM3-T | 2SD669AL-x-TM3-T | TO-251 | E | C | B | Tube |
| 2SD669A-x-TN3-R | 2SD669AL-x-TN3-R | TO-252 | B | C | E | Tape Reel |
| 2SD669A-x-TN3-T | 2SD669AL-x-TN3-T | TO-252 | B | C | E | Tube |

| | |
|---|--|
| <p>2SD669L-x-AB3-R</p> <p>(1)Packing Type (2)Package Type (3)Rank (4)Lead Plating</p> | <p>(1) K: Bulk, R: Tape Reel, T: Tube (2) AA3: SOT-223, AB3: SOT-89, T60: TO-126, T6C: TO-126C, TM3: TO-251, TN3: TO-252, T92: TO-92, T9N: TO-92NL (3) x: refer to Classification of h_{FE1} (4) L: Lead Free Plating, Blank: Pb/Sn</p> |
|---|--|

■ ABSOLUTE MAXIMUM RATING (Ta=25 , unless otherwise specified)

| PARAMETER | SYMBOL | RATINGS | UNIT |
|-----------------------------|--------------------|------------|------|
| Collector-Base Voltage | V _{CB0} | 180 | V |
| Collector-Emitter Voltage | 2SD669 | 120 | V |
| | 2SD669A | 160 | |
| Emitter-Base Voltage | V _{EBO} | 5 | V |
| Collector Current | I _C | 1.5 | A |
| Collector Peak Current | I _{C(PK)} | 3 | A |
| Collector Power Dissipation | P _D | SOT-223 | 0.5 |
| Collector Power Dissipation | | TO-126 | 1 |
| Junction Temperature | T _J | +150 | |
| Storage Temperature | T _{STG} | -40 ~ +150 | |

Note Absolute maximum ratings are those values beyond which the device could be permanently damaged. Absolute maximum ratings are stress ratings only and functional device operation is not implied.

■ ELECTRICAL CHARACTERISTICS (Ta=25 , unless otherwise specified)

| PARAMETER | SYMBOL | TEST CONDITIONS | MIN | TYP | MAX | UNIT |
|--|----------------------|--|---------|-----|-----|------|
| Collector to Base Breakdown Voltage | BV _{CB0} | I _C =1mA, I _E =0 | 180 | | | V |
| Collector to Emitter Breakdown Voltage | BV _{CEO} | I _C =10mA, R _{BE} =∞ | 2SD669 | 120 | | V |
| | | | 2SD669A | 160 | | |
| Emitter to Base Breakdown Voltage | BV _{EBO} | I _E =1mA, I _C =0 | 5 | | | V |
| Collector Cut-off Current | I _{CB0} | V _{CB} =160V, I _E =0 | | | 10 | μA |
| DC Current Gain | h _{FE1} | V _{CE} =5V, I _C =150mA (Note) | 60 | | 320 | |
| | h _{FE2} | V _{CE} =5V, I _C =500mA (Note) | 30 | | | |
| Collector-Emitter Saturation Voltage | V _{CE(SAT)} | I _C =600mA, I _B =50mA (Note) | | | 1 | V |
| Base-Emitter Voltage | V _{BE} | V _{CE} =5V, I _C =150mA (Note) | | | 1.5 | V |
| Current Gain Bandwidth Product | f _T | V _{CE} =5V, I _C =150mA (Note) | | 140 | | MHz |
| Output Capacitance | C _{ob} | V _{CB} =10V, I _E =0, f=1MHz | | 14 | | pF |

Note: Pulse test.

■ CLASSIFICATION OF h_{FE1}

| RANK | B | C | D |
|-------|--------|---------|---------|
| RANGE | 60-120 | 100-200 | 160-320 |

TYPICAL CHARACTERISTICS

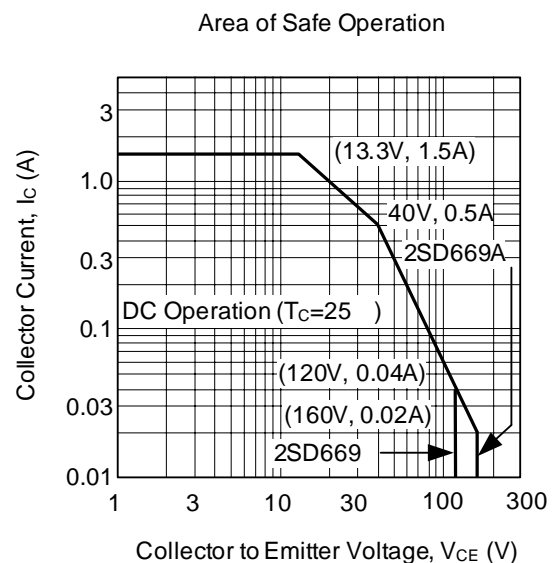
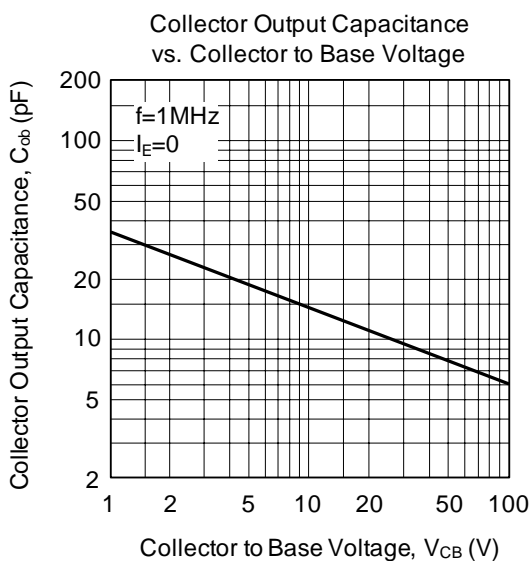
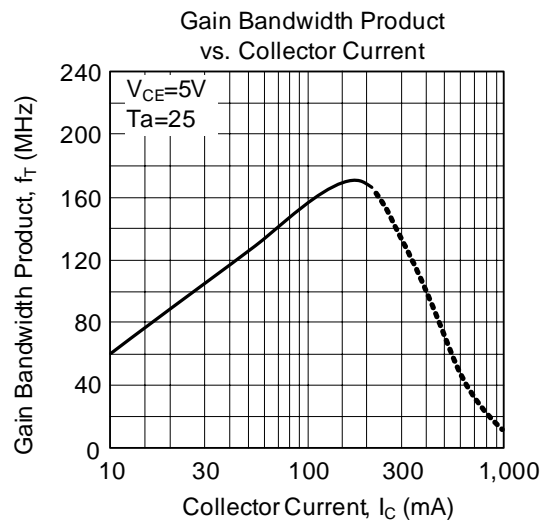
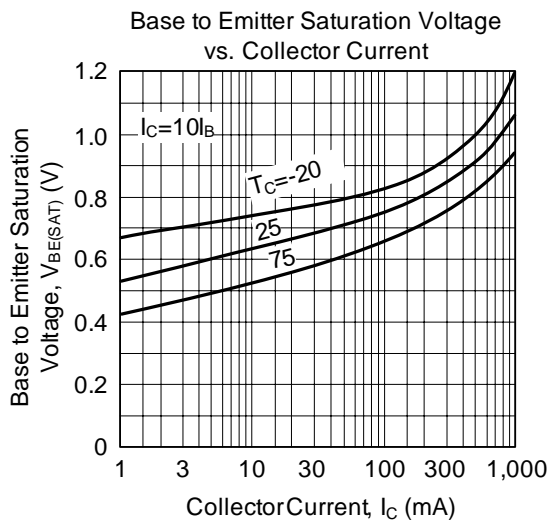
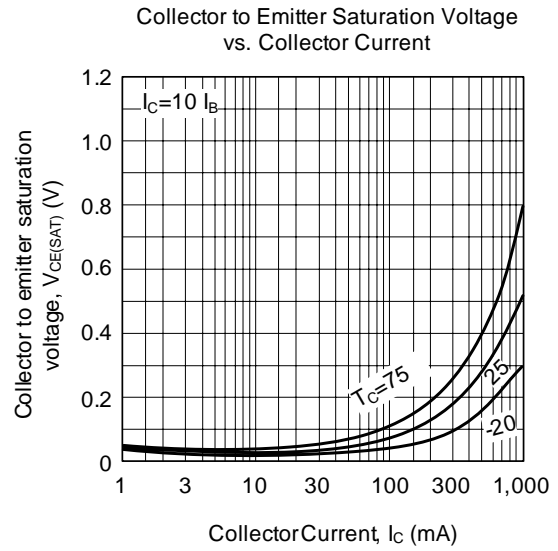
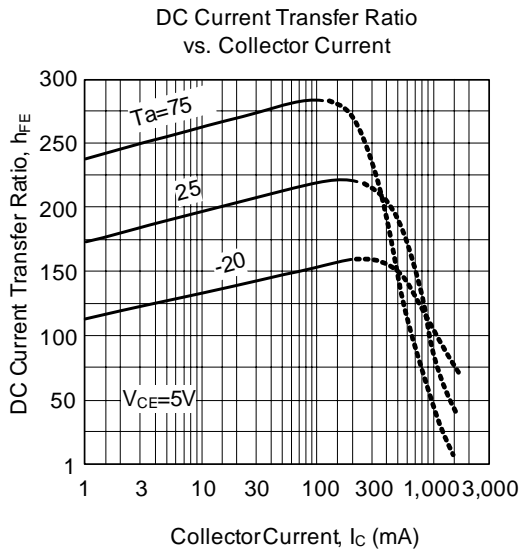

■ TYPICAL CHARACTERISTICS(Cont.)

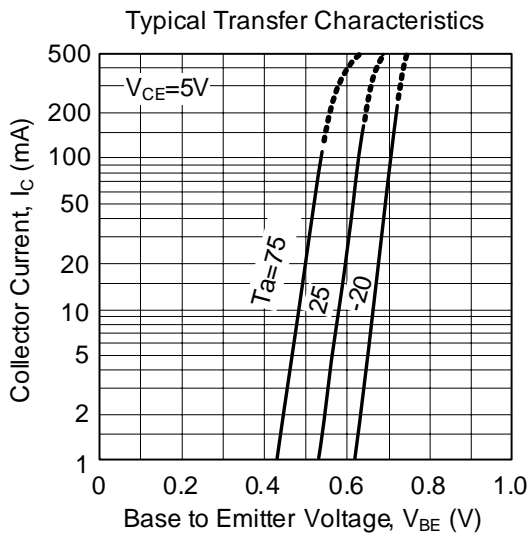

UTC assumes no responsibility for equipment failures that result from using products at values that exceed, even momentarily, rated values (such as maximum ratings, operating condition ranges, or other parameters) listed in products specifications of any and all UTC products described or contained herein. UTC products are not designed for use in life support appliances, devices or systems where malfunction of these products can be reasonably expected to result in personal injury. Reproduction in whole or in part is prohibited without the prior written consent of the copyright owner. The information presented in this document does not form part of any quotation or contract, is believed to be accurate and reliable and may be changed without notice.