



BDX53B / BDX53C BDX54B / BDX54C

COMPLEMENTARY SILICON POWER DARLINGTON TRANSISTORS

- STMicroelectronics PREFERRED SALESTYPES

APPLICATIONS

- AUDIO AMPLIFIERS
- LINEAR AND SWITCHING INDUSTRIAL EQUIPMENT

DESCRIPTION

The BDX53B and BDX53C are silicon Epitaxial-Base NPN power transistors in monolithic Darlington configuration mounted in Jedec TO-220 plastic package. They are intended for use in hammer drivers, audio amplifiers and other medium power linear and switching applications.

The complementary PNP types are BDX54B and BDX54C respectively.

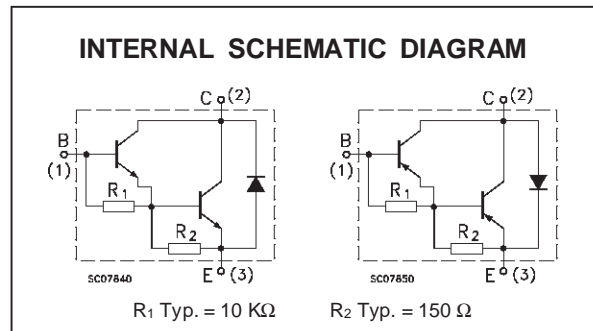
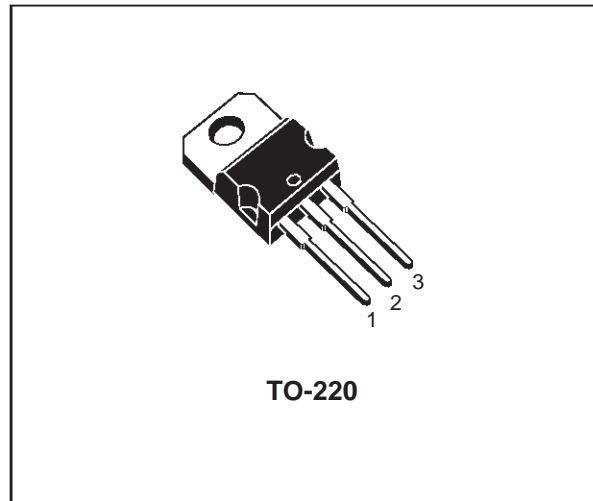

ABSOLUTE MAXIMUM RATINGS

Symbol	Parameter	Value		Unit	
		NPN	BDX53B		BDX53C
		PNP	BDX54B		BDX54C
V_{CBO}	Collector-Base Voltage ($I_E = 0$)	80	100	V	
V_{CEO}	Collector-Emitter Voltage ($I_B = 0$)	80	100	V	
V_{EBO}	Emitter-base Voltage ($I_C = 0$)	5		V	
I_C	Collector Current	8		A	
I_{CM}	Collector Peak Current (repetitive)	12		A	
I_B	Base Current	0.2		A	
P_{tot}	Total Dissipation at $T_c \leq 25^\circ\text{C}$	60		W	
T_{stg}	Storage Temperature	-65 to 150		$^\circ\text{C}$	
T_j	Max. Operating Junction Temperature	150		$^\circ\text{C}$	

For PNP types voltage and current values are negative.

BDX53B - BDX53C - BDX54B - BDX54C

THERMAL DATA

R _{thj-case}	Thermal Resistance Junction-case	Max	2.08	°C/W
R _{thj-amb}	Thermal Resistance Junction-ambient	Max	70	°C/W

ELECTRICAL CHARACTERISTICS (T_{case} = 25 °C unless otherwise specified)

Symbol	Parameter	Test Conditions	Min.	Typ.	Max.	Unit
I _{CBO}	Collector Cut-off Current (I _E = 0)	for BDX53B/54B V _{CB} = 80 V for BDX53C/54C V _{CB} = 100V			0.2 0.2	mA mA
I _{CEO}	Collector Cut-off Current (I _B = 0)	for BDX53B/54B V _{CE} = 40 V for BDX53C/54C V _{CE} = 50V			0.5 0.5	mA mA
I _{EBO}	Emitter Cut-off Current (I _C = 0)	V _{EB} = 5 V			2	mA
V _{CEO(sus)*}	Collector-Emitter Sustaining Voltage (I _B = 0)	I _C = 100 mA for BDX53B/54B for BDX53C/54C	80 100			V V
V _{CE(sat)*}	Collector-emitter Saturation Voltage	I _C = 3 A I _B = 12 mA			2	V
V _{BE(sat)*}	Base-emitter Saturation Voltage	I _C = 3 A I _B = 12 mA			2.5	V
h _{FE*}	DC Current Gain	I _C = 3 A V _{CE} = 3 V	750			
V _{F*}	Parallel-diode Forward Voltage	I _F = 3 A I _F = 8 A		1.8 2.5	2.5	V V

* Pulsed: Pulse duration = 300 μs, duty cycle 1.5 %

For PNP types voltage and current values are negative.

Safe Operating Area

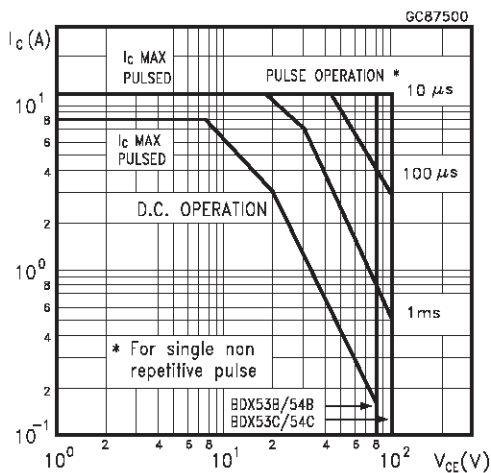

Derating Curve

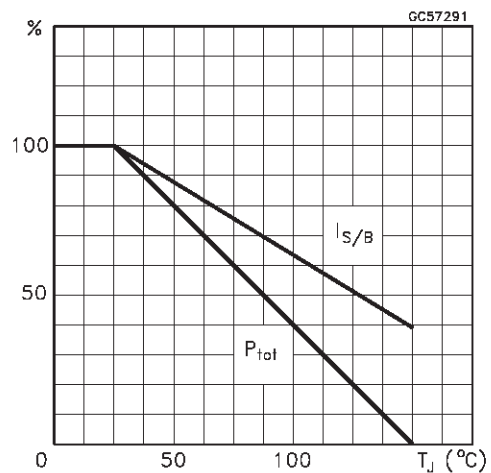

DC Current Gain (NPN type)

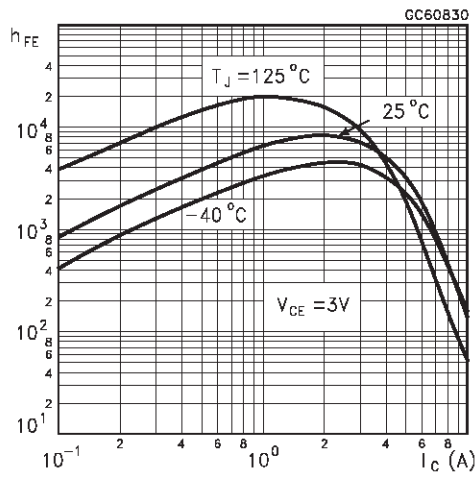

DC Current Gain (PNP type)

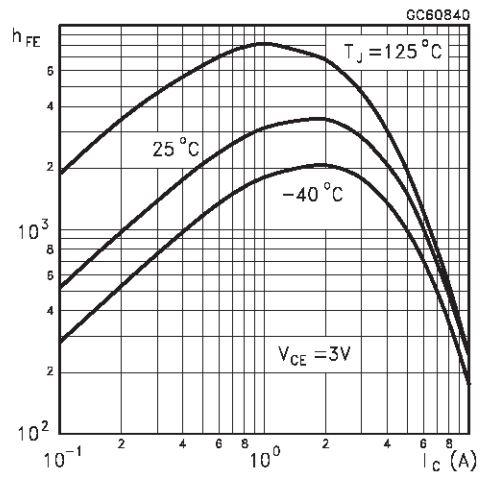

Collector Emitter Saturation Voltage (NPN type)

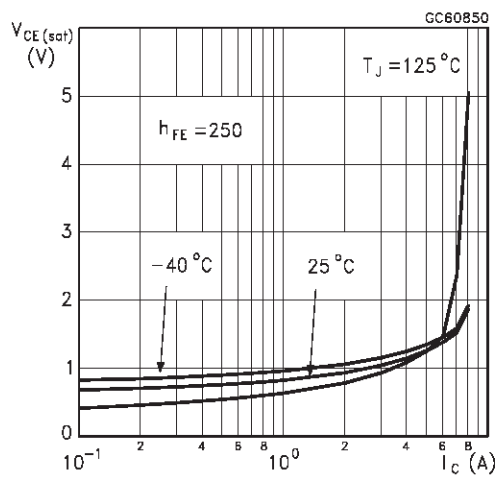

Collector Emitter Saturation Voltage (PNP type)

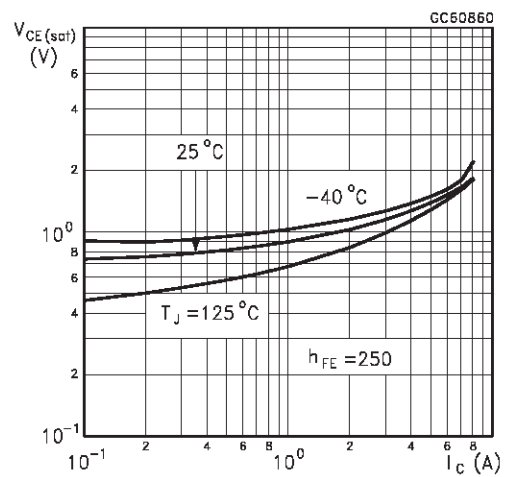

Base Emitter Saturation Voltage (NPN type)

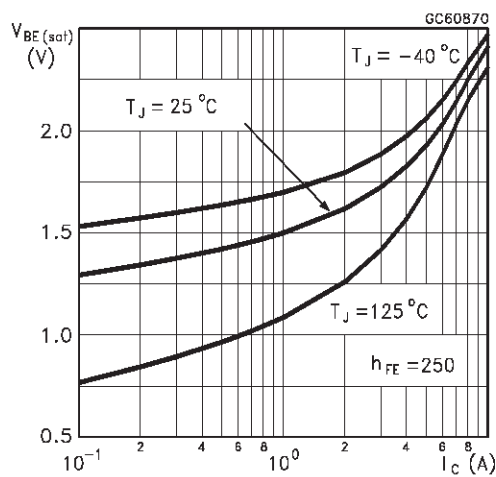

Base Emitter Saturation Voltage (PNP type)

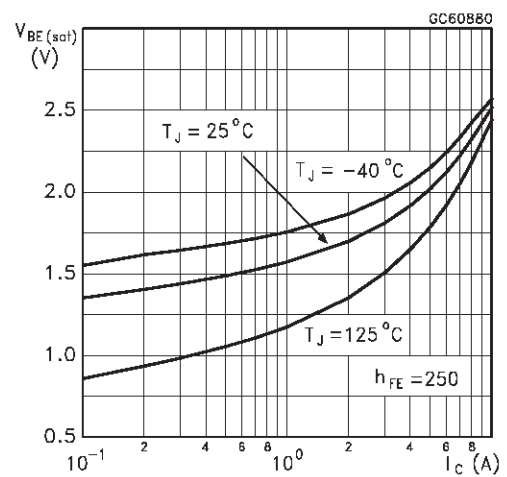

BDX53B - BDX53C - BDX54B - BDX54C

Base Emitter On Voltage (NPN type)

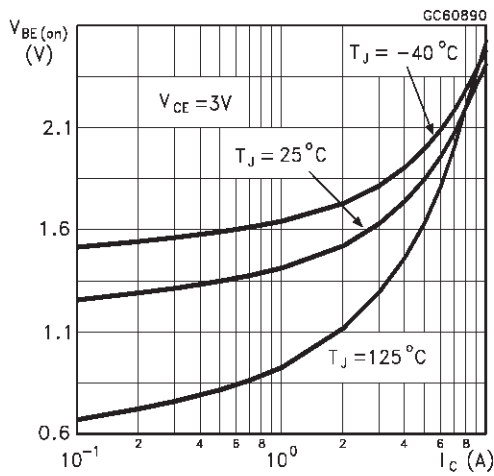

Base Emitter On Voltage (PNP type)

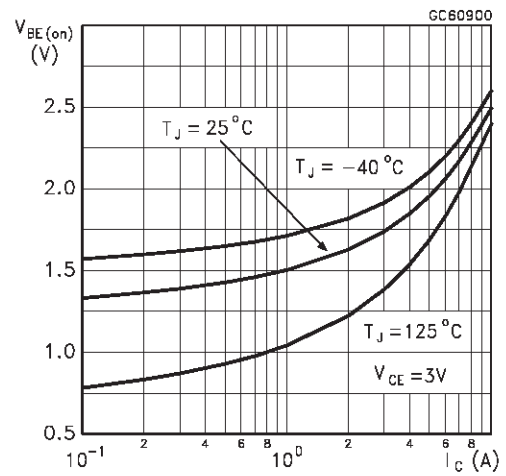

Freewheel Diode Forward Voltage (NPN type)

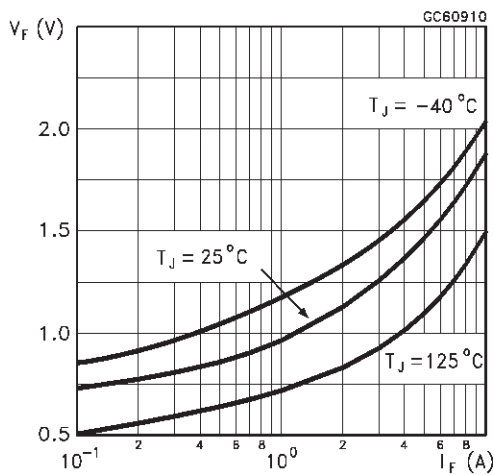

Freewheel Diode Forward Voltage (PNP type)

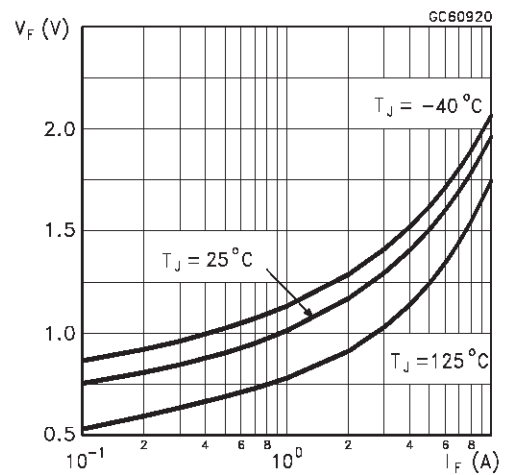

Switching Time Resistive Load (NPN type)

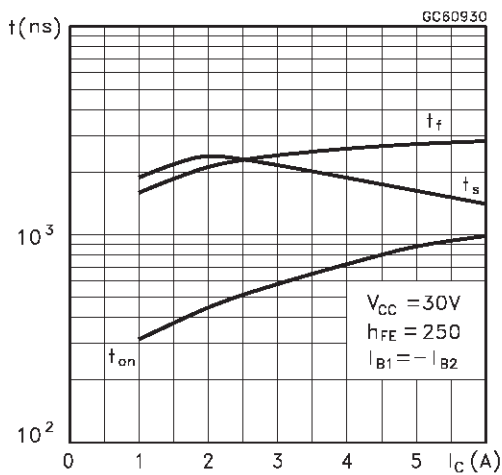

Switching Time resistive Load (PNP type)

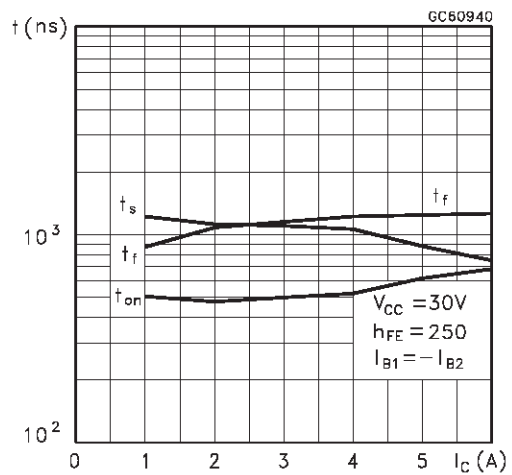

TO-220 MECHANICAL DATA

DIM.	mm			inch		
	MIN.	TYP.	MAX.	MIN.	TYP.	MAX.
A	4.40		4.60	0.173		0.181
C	1.23		1.32	0.048		0.051
D	2.40		2.72	0.094		0.107
D1		1.27			0.050	
E	0.49		0.70	0.019		0.027
F	0.61		0.88	0.024		0.034
F1	1.14		1.70	0.044		0.067
F2	1.14		1.70	0.044		0.067
G	4.95		5.15	0.194		0.203
G1	2.4		2.7	0.094		0.106
H2	10.0		10.40	0.393		0.409
L2		16.4			0.645	
L4	13.0		14.0	0.511		0.551
L5	2.65		2.95	0.104		0.116
L6	15.25		15.75	0.600		0.620
L7	6.2		6.6	0.244		0.260
L9	3.5		3.93	0.137		0.154
DIA.	3.75		3.85	0.147		0.151

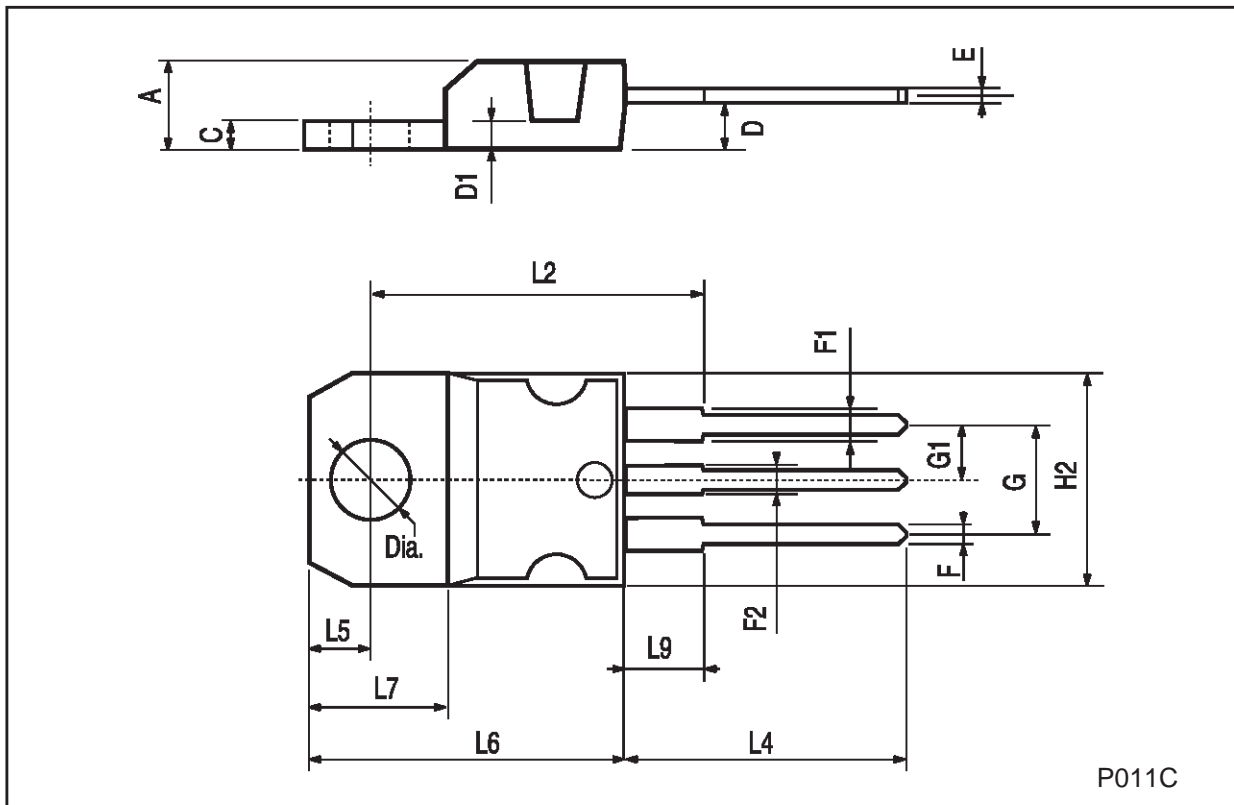

Information furnished is believed to be accurate and reliable. However, STMicroelectronics assumes no responsibility for the consequences of use of such information nor for any infringement of patents or other rights of third parties which may result from its use. No license is granted by implication or otherwise under any patent or patent rights of STMicroelectronics. Specification mentioned in this publication are subject to change without notice. This publication supersedes and replaces all information previously supplied. STMicroelectronics products are not authorized for use as critical components in life support devices or systems without express written approval of STMicroelectronics.

The ST logo is a trademark of STMicroelectronics

© 1999 STMicroelectronics – Printed in Italy – All Rights Reserved

STMicroelectronics GROUP OF COMPANIES

Australia - Brazil - China - Finland - France - Germany - Hong Kong - India - Italy - Japan - Malaysia - Malta - Morocco -
Singapore - Spain - Sweden - Switzerland - United Kingdom - U.S.A.

<http://www.st.com>