

Applications

- High Frequency DC-DC Isolated Converters with Synchronous Rectification for Telecom and Industrial Use
- High Frequency Buck Converters for Computer Processor Power

HEXFET® Power MOSFET

| | | |
|------------------------|-------------------------------|----------------------|
| V_{DSS} | R_{DS(on)} max | I_D |
| 30V | 12mΩ | 62A |

Benefits

- Ultra-Low Gate Impedance
- Very Low R_{DS(on)} at 4.5V V_{GS}
- Fully Characterized Avalanche Voltage and Current

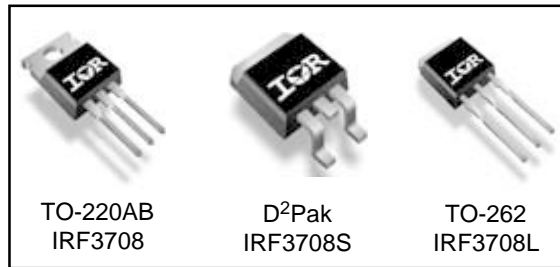

Absolute Maximum Ratings

| Symbol | Parameter | Max. | Units |
|--|---|--------------|-------|
| V _{DS} | Drain-Source Voltage | 30 | V |
| V _{GS} | Gate-to-Source Voltage | ±12 | V |
| I _D @ T _C = 25°C | Continuous Drain Current, V _{GS} @ 10V | 62 | A |
| I _D @ T _C = 70°C | Continuous Drain Current, V _{GS} @ 10V | 52 | |
| I _{DM} | Pulsed Drain Current ^① | 248 | |
| P _D @ T _C = 25°C | Maximum Power Dissipation ^③ | 87 | W |
| P _D @ T _C = 70°C | Maximum Power Dissipation ^③ | 61 | W |
| | Linear Derating Factor | 0.58 | W/°C |
| T _J , T _{STG} | Junction and Storage Temperature Range | -55 to + 175 | °C |

Thermal Resistance

| | Parameter | Typ. | Max. | Units |
|------------------|--|------|------|-------|
| R _{θJC} | Junction-to-Case | — | 1.73 | °C/W |
| R _{θCS} | Case-to-Sink, Flat, Greased Surface ^④ | 0.50 | — | |
| R _{θJA} | Junction-to-Ambient ^④ | — | 62 | |
| R _{θJA} | Junction-to-Ambient (PCB mount)* | — | 40 | |

* When mounted on 1" square PCB (FR-4 or G-10 Material) .
 For recommended footprint and soldering techniques refer to application note #AN-994

Notes ① through ④ are on page 10

IRF3708/3708S/3708L

International
IR Rectifier

Static @ $T_J = 25^\circ\text{C}$ (unless otherwise specified)

| | Parameter | Min. | Typ. | Max. | Units | Conditions |
|---------------------------------|--------------------------------------|------|-------|------|---------------------|--|
| $V_{(BR)DSS}$ | Drain-to-Source Breakdown Voltage | 30 | — | — | V | $V_{GS} = 0V, I_D = 250\mu A$ |
| $\Delta V_{(BR)DSS}/\Delta T_J$ | Breakdown Voltage Temp. Coefficient | — | 0.028 | — | V/ $^\circ\text{C}$ | Reference to $25^\circ\text{C}, I_D = 1\text{mA}$ |
| $R_{DS(on)}$ | Static Drain-to-Source On-Resistance | — | 8 | 12.0 | m Ω | $V_{GS} = 10V, I_D = 15A$ ③ |
| | | — | 9.5 | 13.5 | | $V_{GS} = 4.5V, I_D = 12A$ ③ |
| | | — | 14.5 | 29 | | $V_{GS} = 2.8V, I_D = 7.5A$ ③ |
| $V_{GS(th)}$ | Gate Threshold Voltage | 0.6 | — | 2.0 | V | $V_{DS} = V_{GS}, I_D = 250\mu A$ |
| I_{DSS} | Drain-to-Source Leakage Current | — | — | 20 | μA | $V_{DS} = 24V, V_{GS} = 0V$ |
| | | — | — | 100 | | $V_{DS} = 24V, V_{GS} = 0V, T_J = 125^\circ\text{C}$ |
| I_{GSS} | Gate-to-Source Forward Leakage | — | — | 200 | nA | $V_{GS} = 12V$ |
| | Gate-to-Source Reverse Leakage | — | — | -200 | | $V_{GS} = -12V$ |

Dynamic @ $T_J = 25^\circ\text{C}$ (unless otherwise specified)

| Symbol | Parameter | Min. | Typ. | Max. | Units | Conditions |
|--------------|---------------------------------|------|------|------|-------|---|
| g_{fs} | Forward Transconductance | 49 | — | — | S | $V_{DS} = 15V, I_D = 50A$ |
| Q_g | Total Gate Charge | — | 24 | — | nC | $I_D = 24.8A$ $V_{DS} = 15V$ $V_{GS} = 4.5V$ ③ |
| Q_{gs} | Gate-to-Source Charge | — | 6.7 | — | | |
| Q_{gd} | Gate-to-Drain ("Miller") Charge | — | 5.8 | — | | |
| Q_{oss} | Output Gate Charge | — | 14 | 21 | | |
| $t_{d(on)}$ | Turn-On Delay Time | — | 7.2 | — | ns | $V_{DD} = 15V$ $I_D = 24.8A$ $R_G = 0.6\Omega$ $V_{GS} = 4.5V$ ③ |
| t_r | Rise Time | — | 50 | — | | |
| $t_{d(off)}$ | Turn-Off Delay Time | — | 17.6 | — | | |
| t_f | Fall Time | — | 3.7 | — | | |
| C_{iss} | Input Capacitance | — | 2417 | — | pF | $V_{GS} = 0V$ $V_{DS} = 15V$ $f = 1.0\text{MHz}$ |
| C_{oss} | Output Capacitance | — | 707 | — | | |
| C_{rss} | Reverse Transfer Capacitance | — | 52 | — | | |

Avalanche Characteristics

| Symbol | Parameter | Typ. | Max. | Units |
|----------|--------------------------------|------|------|-------|
| E_{AS} | Single Pulse Avalanche Energy② | — | 213 | mJ |
| I_{AR} | Avalanche Current① | — | 62 | A |

Diode Characteristics

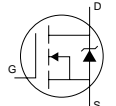
| Symbol | Parameter | Min. | Typ. | Max. | Units | Conditions |
|----------|--|------|------|------|-------|--|
| I_S | Continuous Source Current (Body Diode) | — | — | 62 | A | MOSFET symbol showing the integral reverse p-n junction diode.  |
| I_{SM} | Pulsed Source Current (Body Diode) ① | — | — | 248 | | |
| V_{SD} | Diode Forward Voltage | — | 0.88 | 1.3 | V | $T_J = 25^\circ\text{C}, I_S = 31A, V_{GS} = 0V$ ③ |
| | | — | 0.80 | — | | $T_J = 125^\circ\text{C}, I_S = 31A, V_{GS} = 0V$ ③ |
| t_{rr} | Reverse Recovery Time | — | 41 | 62 | ns | $T_J = 25^\circ\text{C}, I_F = 31A, V_R = 20V$ |
| Q_{rr} | Reverse Recovery Charge | — | 64 | 96 | nC | $di/dt = 100A/\mu s$ ③ |
| t_{rr} | Reverse Recovery Time | — | 43 | 65 | ns | $T_J = 125^\circ\text{C}, I_F = 31A, V_R = 20V$ |
| Q_{rr} | Reverse Recovery Charge | — | 70 | 105 | nC | $di/dt = 100A/\mu s$ ③ |

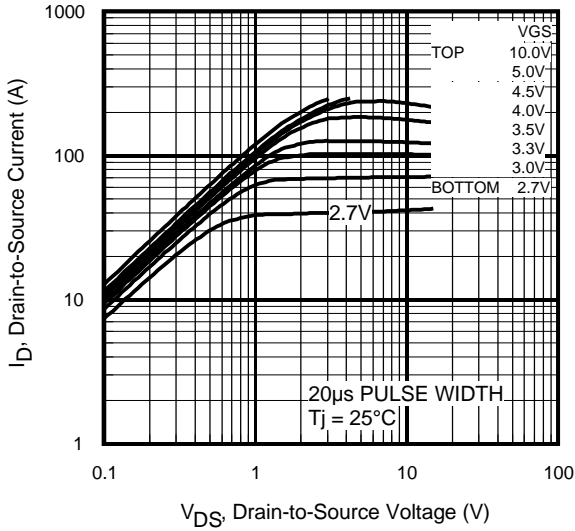

Fig 1. Typical Output Characteristics

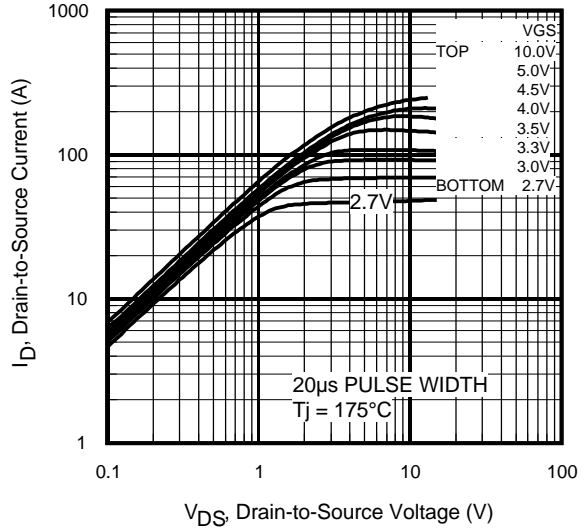

Fig 2. Typical Output Characteristics

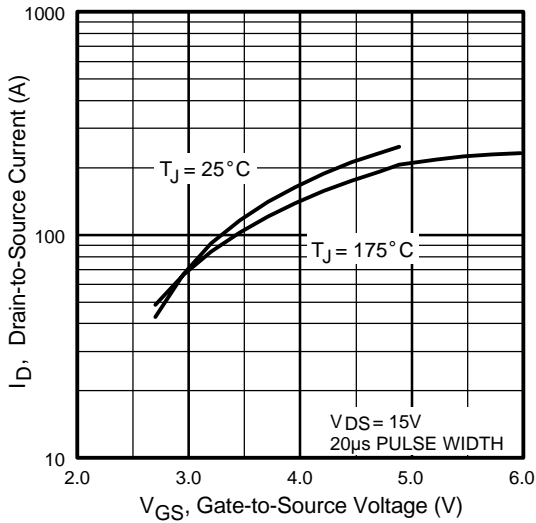

Fig 3. Typical Transfer Characteristics

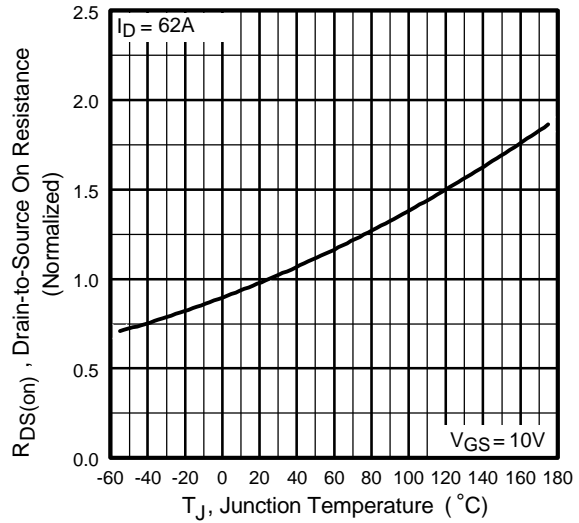

Fig 4. Normalized On-Resistance Vs. Temperature

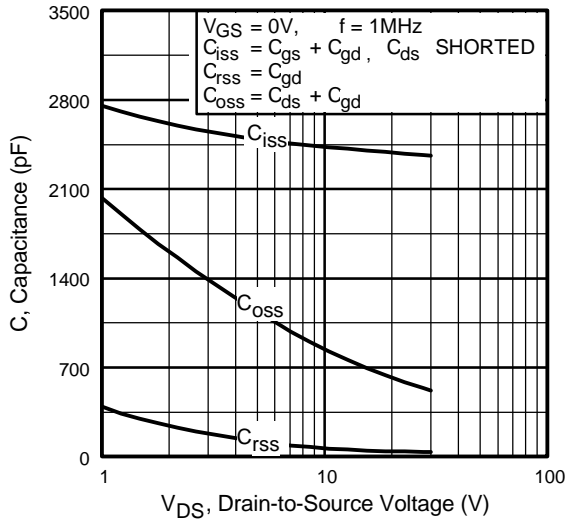

Fig 5. Typical Capacitance Vs. Drain-to-Source Voltage

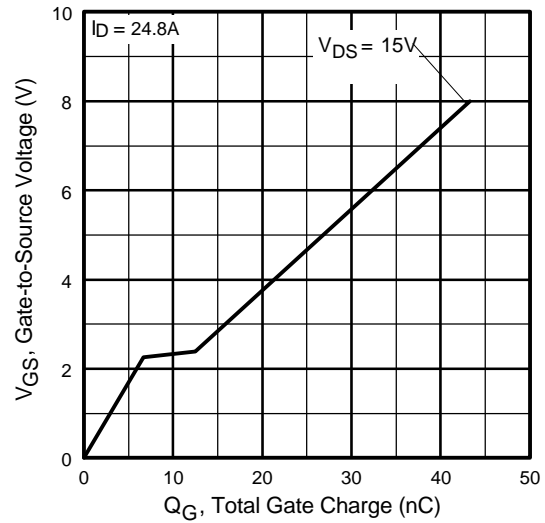

Fig 6. Typical Gate Charge Vs. Gate-to-Source Voltage

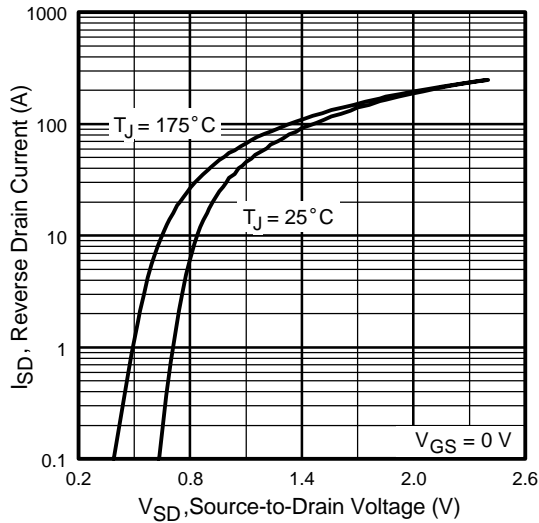

Fig 7. Typical Source-Drain Diode Forward Voltage

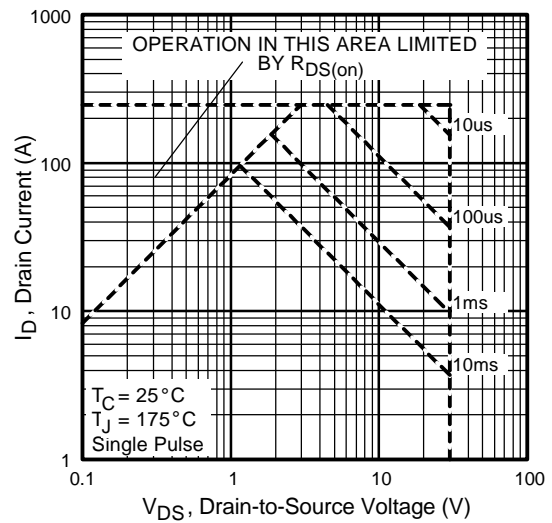

Fig 8. Maximum Safe Operating Area

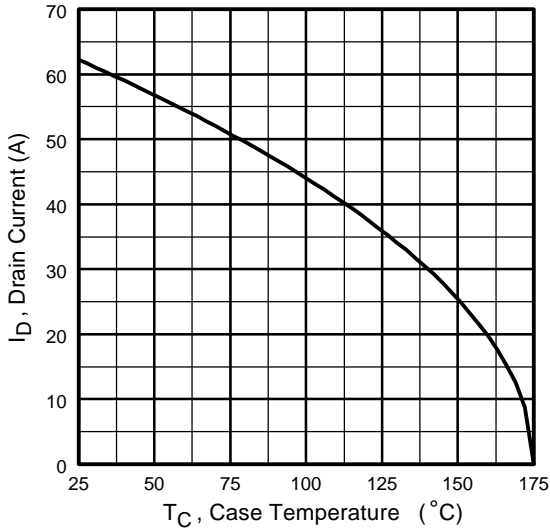

Fig 9. Maximum Drain Current Vs. Case Temperature

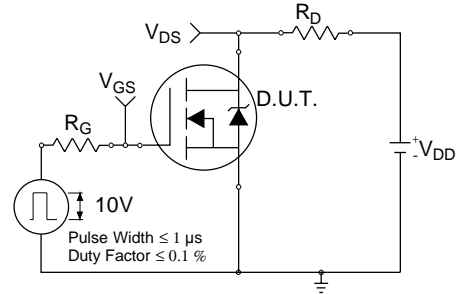

Fig 10a. Switching Time Test Circuit

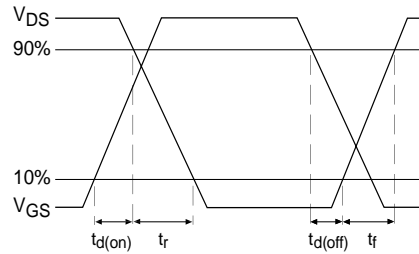

Fig 10b. Switching Time Waveforms

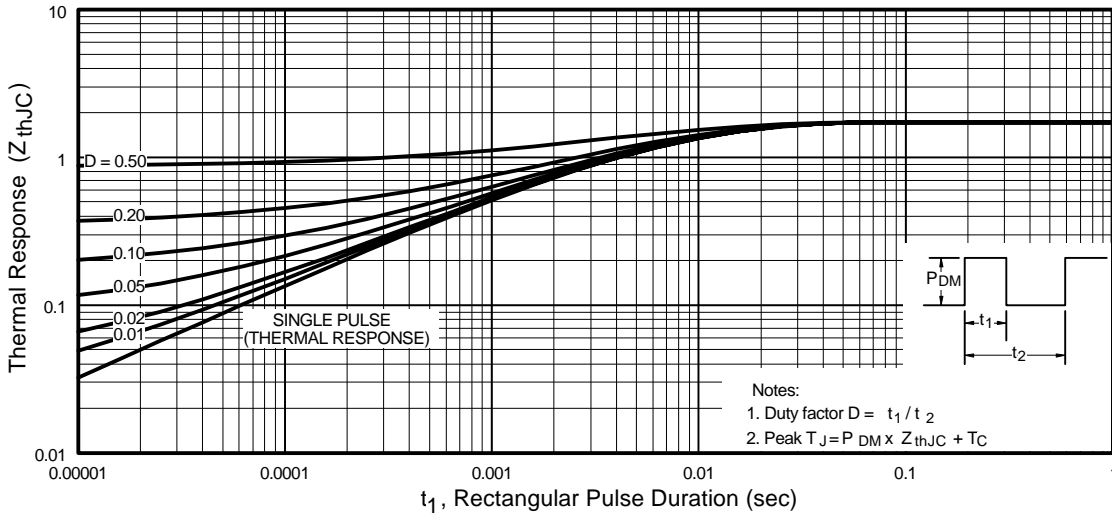

Fig 11. Maximum Effective Transient Thermal Impedance, Junction-to-Case

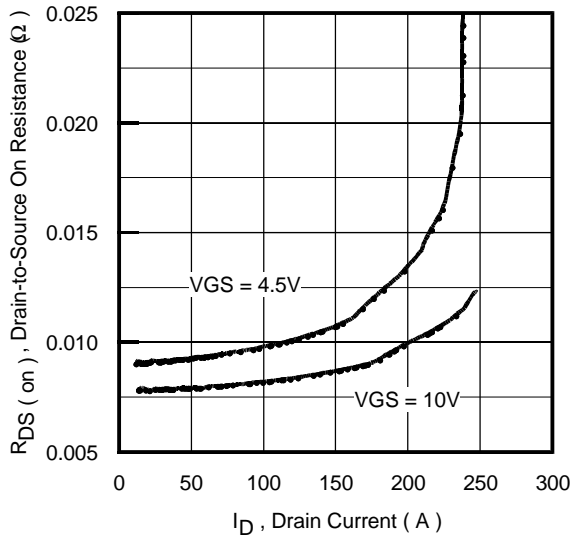

Fig 12. On-Resistance Vs. Drain Current

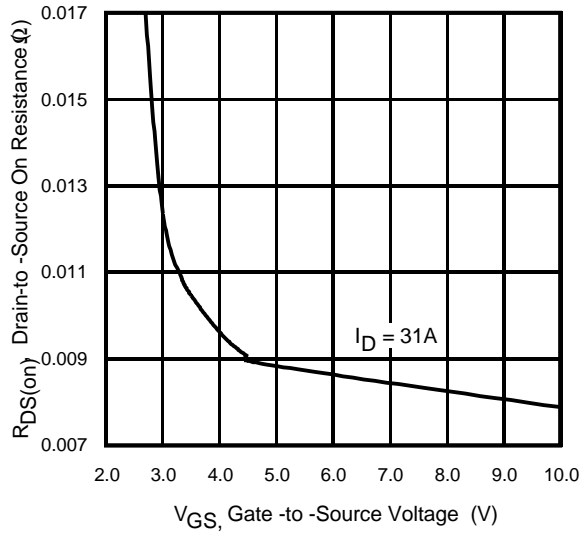

Fig 13. On-Resistance Vs. Gate Voltage

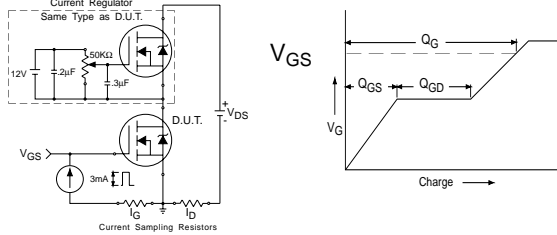

Fig 14a&b. Gate Charge Test Circuit and Waveform

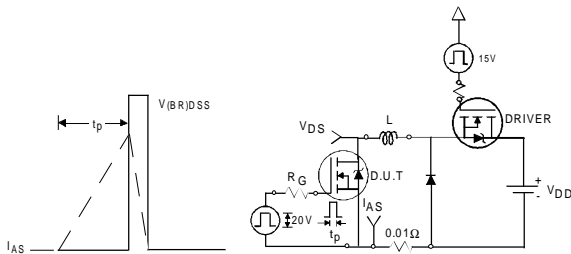

Fig 15a&b. Unclamped Inductive Test circuit and Waveforms

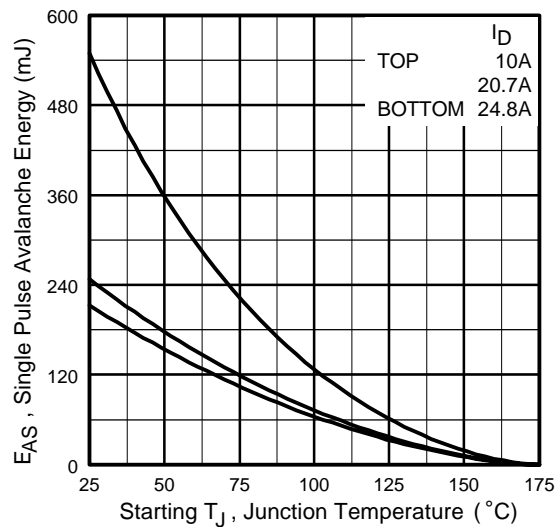
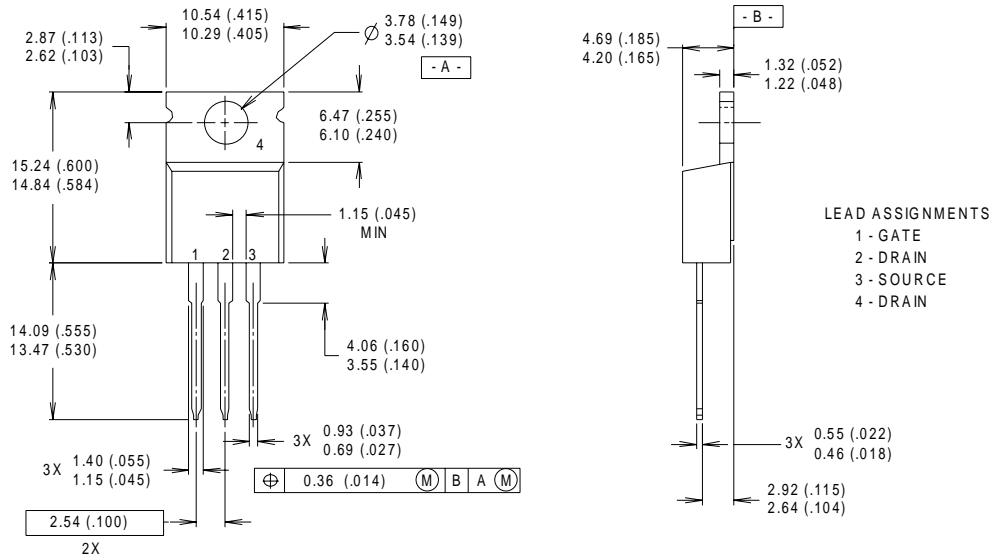

Fig 15c. Maximum Avalanche Energy Vs. Drain Current

TO-220AB Package Outline

Dimensions are shown in millimeters (inches)



NOTES:

- 1 DIMENSIONING & TOLERANCING PER ANSI Y14.5M, 1982.
- 2 CONTROLLING DIMENSION : INCH
- 3 OUTLINE CONFORMS TO JEDEC OUTLINE TO-220AB.
- 4 HEATSINK & LEAD MEASUREMENTS DO NOT INCLUDE BURRS.

TO-220AB Part Marking Information

EXAMPLE : THIS IS AN IRF1010
 WITH ASSEMBLY
 LOT CODE 9B1M



IRF3708/3708S/3708L

International
IR Rectifier

D²Pak Package Outline

Dimensions are shown in millimeters (inches)

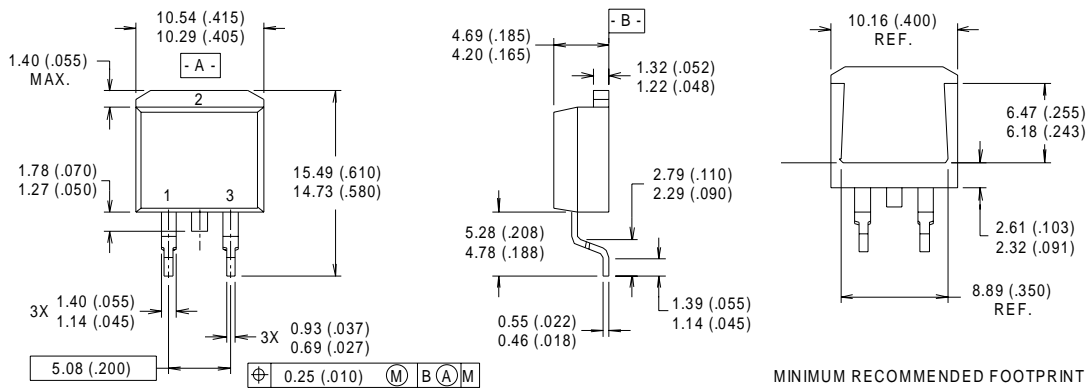

NOTES:

- 1 DIMENSIONS AFTER SOLDER DIP.
- 2 DIMENSIONING & TOLERANCING PER ANSI Y14.5M, 1982.
- 3 CONTROLLING DIMENSION : INCH.
- 4 HEATSINK & LEAD DIMENSIONS DO NOT INCLUDE BURRS.

LEAD ASSIGNMENTS

- 1 - GATE
- 2 - DRAIN
- 3 - SOURCE

D²Pak Part Marking Information

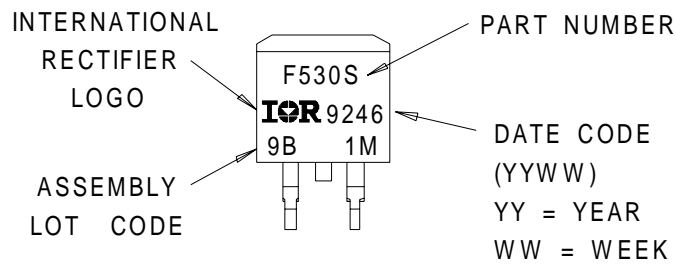

TO-262 Package Outline

Dimensions are shown in millimeters (inches)

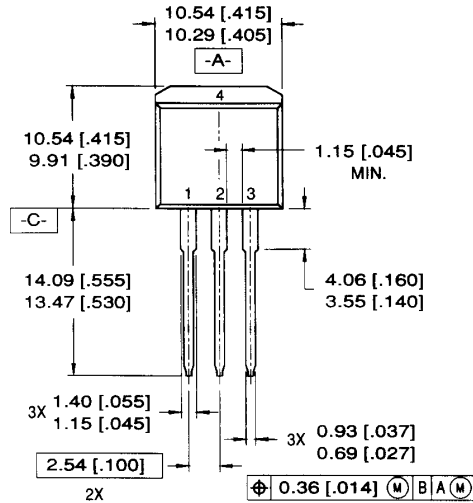

LEAD ASSIGNMENTS

- | | |
|-----------|------------|
| 1 = GATE | 3 = SOURCE |
| 2 = DRAIN | 4 = DRAIN |

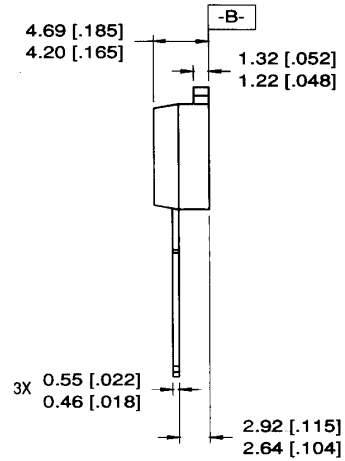

NOTES:

1. DIMENSIONING & TOLERANCING PER ANSI Y14.5M-1982
2. CONTROLLING DIMENSION: INCH.
3. DIMENSIONS ARE SHOWN IN MILLIMETERS [INCHES].
4. HEATSINK & LEAD DIMENSIONS DO NOT INCLUDE BURRS.

TO-262 Part Marking Information

EXAMPLE: THIS IS AN IRL3103L
 LOT CODE 1789
 ASSEMBLED ON WW 19, 1997
 IN THE ASSEMBLY LINE "C"

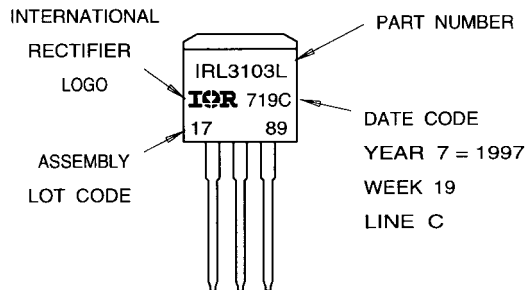

IRF3708/3708S/3708L

International
IR Rectifier

D²Pak Tape & Reel Information

Dimensions are shown in millimeters (inches)

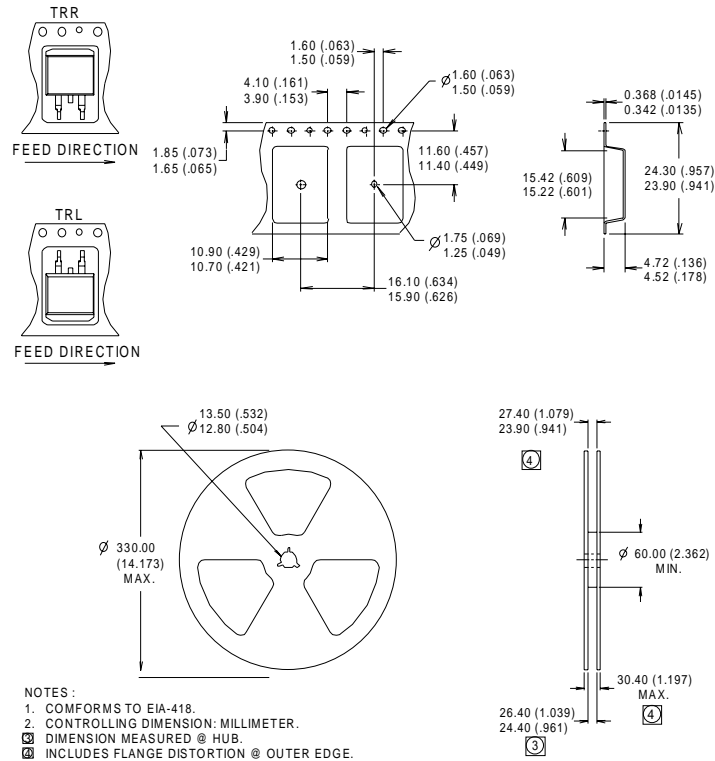

Notes:

- ① Repetitive rating; pulse width limited by max. junction temperature.
- ② Starting $T_J = 25^\circ\text{C}$, $L = 0.7$ mH
 $R_G = 25\Omega$, $I_{AS} = 24.8$ A.
- ③ Pulse width $\leq 300\mu\text{s}$; duty cycle $\leq 2\%$.
- ④ This is only applied to TO-220AB package

International
IR Rectifier

IR WORLD HEADQUARTERS: 233 Kansas St., El Segundo, California 90245, USA Tel: (310) 252-7105

IR EUROPEAN REGIONAL CENTRE: 439/445 Godstone Rd, Whyteleafe, Surrey CR3 OBL, UK Tel: ++ 44 (0)20 8645 8000

IR CANADA: 15 Lincoln Court, Brampton, Ontario L6T3Z2, Tel: (905) 453 2200

IR GERMANY: Saalburgstrasse 157, 61350 Bad Homburg Tel: ++ 49 (0) 6172 96590

IR ITALY: Via Liguria 49, 10071 Borgaro, Torino Tel: ++ 39 011 451 0111

IR JAPAN: K&H Bldg., 2F, 30-4 Nishi-Ikebukuro 3-Chome, Toshima-Ku, Tokyo 171 Tel: 81 (0)3 3983 0086

IR SOUTHEAST ASIA: 1 Kim Seng Promenade, Great World City West Tower, 13-11, Singapore 237994 Tel: ++ 65 (0)838 4630

IR TAIWAN: 16 Fl. Suite D. 207, Sec. 2, Tun Haw South Road, Taipei, 10673 Tel: 886-(0)2 2377 9936

Data and specifications subject to change without notice. 8/00