

Features

- 0.56 INCH DIGIT HEIGHT.
- LOW CURRENT OPERATION.
- EXCELLENT CHARACTER APPEARANCE.
- EASY MOUNTING ON P.C. BOARDS OR SOCKETS.
- I.C. COMPATIBLE.
- MECHANICALLY RUGGED.
- STANDARD : GRAY FACE, WHITE SEGMENT.
- RoHS COMPLIANT.

Description

The High Efficiency Red source color devices are made with Gallium Arsenide Phosphide on Gallium Phosphide Orange Light Emitting Diode.

Package Dimensions & Internal Circuit Diagram

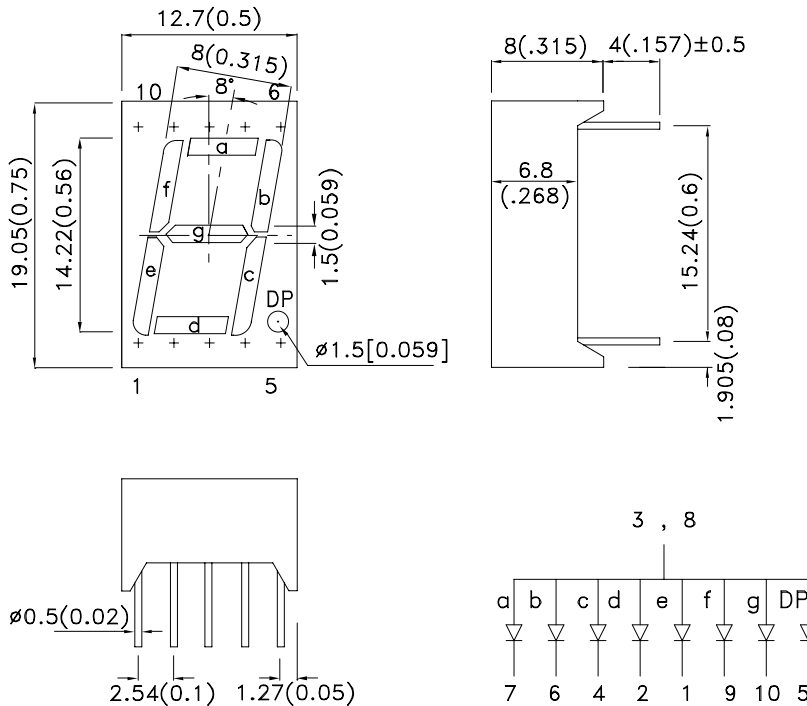

Notes:

1. All dimensions are in millimeters (inches), Tolerance is $\pm 0.25(0.01)$ unless otherwise noted.
2. Specifications are subject to change without notice.



Selection Guide

Part No.	Dice	Lens Type	Iv (ucd) [1] @ 10mA		Description
			Min.	Typ.	
SA56-11EWA	High Efficiency Red (GaAsP/GaP)	WHITE DIFFUSED	1200	6400	Common Anode, Rt. Hand Decimal.

Note:

1. Luminous intensity/ luminous Flux: +/-15%.

Electrical / Optical Characteristics at TA=25°C

Symbol	Parameter	Device	Typ.	Max.	Units	Test Conditions
λ_{peak}	Peak Wavelength	High Efficiency Red	627		nm	I _F =20mA
λ_D [1]	Dominant Wavelength	High Efficiency Red	625		nm	I _F =20mA
$\Delta\lambda_{1/2}$	Spectral Line Half-width	High Efficiency Red	45		nm	I _F =20mA
C	Capacitance	High Efficiency Red	15		pF	V _F =0V;f=1MHz
V _F [2]	Forward Voltage	High Efficiency Red	2.0	2.5	V	I _F =20mA
I _R	Reverse Current	High Efficiency Red		10	uA	V _R =5V

Notes:

1. Wavelength: +/-1nm.
2. Forward Voltage: +/-0.1V.

Absolute Maximum Ratings at TA=25°C

Parameter	High Efficiency Red	Units
Power dissipation	75	mW
DC Forward Current	30	mA
Peak Forward Current [1]	160	mA
Reverse Voltage	5	V
Operating / Storage Temperature	-40°C To +85°C	
Lead Solder Temperature[2]	260°C For 3-5 Seconds	

Notes:

1. 1/10 Duty Cycle, 0.1ms Pulse Width.
2. 2mm below package base.



High Efficiency Red SA56-11EWA

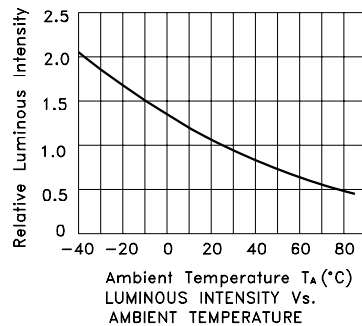
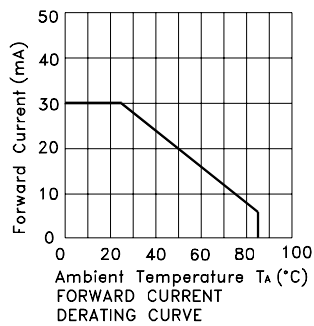
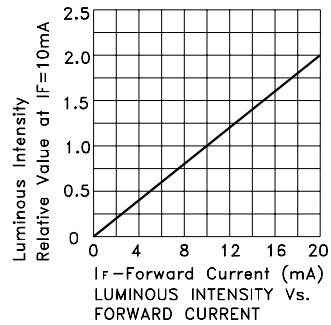
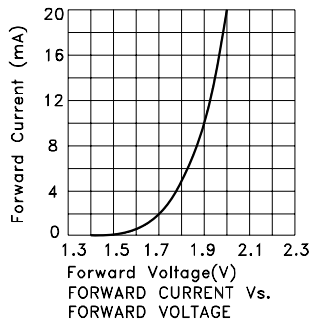

PACKING & LABEL SPECIFICATIONS

SA56-11EWA

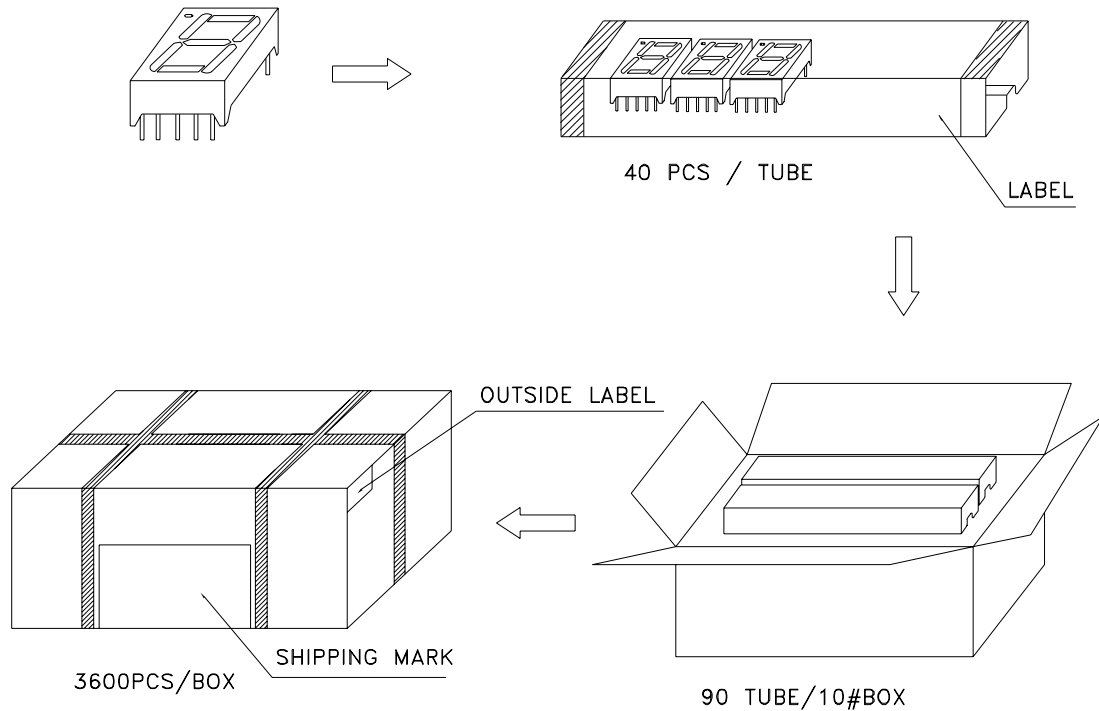

Inside LABEL Paste On The IC-TUBE

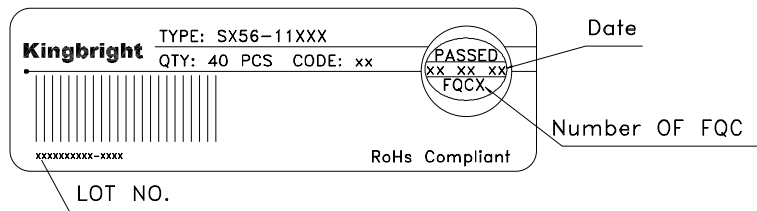

Outside LABEL Paste On The Box

