

NPN SILICON TRANSISTORS

Type	Marking
BD135	BD135
BD135-10	BD135-10
BD135-16	BD135-16
BD139	BD139
BD139-10	BD139-10
BD139-16	BD139-16

- STMicroelectronics PREFERRED SALESTYPES

DESCRIPTION

The BD135 and BD139 are silicon Epitaxial Planar NPN transistors mounted in Jedec SOT-32 plastic package, designed for audio amplifiers and drivers utilizing complementary or quasi-complementary circuits.

The complementary PNP types are BD136 and BD140 respectively.

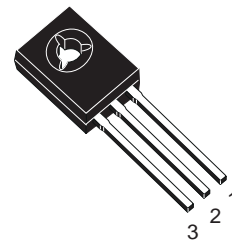

SOT-32

INTERNAL SCHEMATIC DIAGRAM

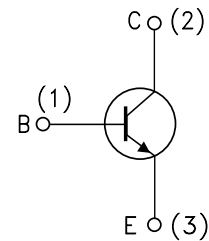

SC06960

ABSOLUTE MAXIMUM RATINGS

Symbol	Parameter	Value		Unit
		BD135	BD139	
V_{CBO}	Collector-Base Voltage ($I_E = 0$)	45	80	V
V_{CEO}	Collector-Emitter Voltage ($I_B = 0$)	45	80	V
V_{EBO}	Emitter-Base Voltage ($I_C = 0$)	5		V
I_C	Collector Current	1.5		A
I_{CM}	Collector Peak Current	3		A
I_B	Base Current	0.5		A
P_{tot}	Total Dissipation at $T_c \leq 25\text{ }^\circ\text{C}$	12.5		W
P_{tot}	Total Dissipation at $T_{amb} \leq 25\text{ }^\circ\text{C}$	1.25		W
T_{stg}	Storage Temperature	-65 to 150		$^\circ\text{C}$
T_j	Max. Operating Junction Temperature	150		$^\circ\text{C}$

BD135 / BD139

THERMAL DATA

R _{thj-case}	Thermal Resistance Junction-case	Max	10	°C/W
-----------------------	----------------------------------	-----	----	------

ELECTRICAL CHARACTERISTICS (T_{case} = 25 °C unless otherwise specified)

Symbol	Parameter	Test Conditions	Min.	Typ.	Max.	Unit
I _{CBO}	Collector Cut-off Current (I _E = 0)	V _{CB} = 30 V V _{CB} = 30 V T _C = 125 °C			0.1 10	μA μA
I _{EBO}	Emitter Cut-off Current (I _C = 0)	V _{EB} = 5 V			10	μA
V _{CEO(sus)*}	Collector-Emitter Sustaining Voltage (I _B = 0)	I _C = 30 mA for BD135 for BD139	45 80			V V
V _{CE(sat)*}	Collector-Emitter Saturation Voltage	I _C = 0.5 A I _B = 0.05 A			0.5	V
V _{BE*}	Base-Emitter Voltage	I _C = 0.5 A V _{CE} = 2 V			1	V
h _{FE*}	DC Current Gain	I _C = 5 mA V _{CE} = 2 V I _C = 150 mA V _{CE} = 2 V I _C = 0.5 A V _{CE} = 2 V	25 40 25		250	
h _{FE}	h _{FE} Groups	I _C = 150 mA V _{CE} = 2 V for BD135/BD139 group-10 for BD135/BD139 group-16	63 100		160 250	

* Pulsed: Pulse duration = 300 μs, duty cycle 1.5 %

Safe Operating Area

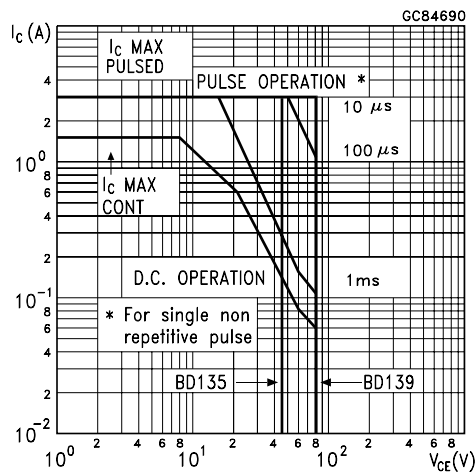

SOT-32 (TO-126) MECHANICAL DATA

DIM.	mm			inch		
	MIN.	TYP.	MAX.	MIN.	TYP.	MAX.
A	7.4		7.8	0.291		0.307
B	10.5		10.8	0.413		0.425
b	0.7		0.9	0.028		0.035
b1	0.40		0.65	0.015		0.025
C	2.4		2.7	0.094		0.106
c1	1.0		1.3	0.039		0.051
D	15.4		16.0	0.606		0.630
e		2.2			0.087	
e3		4.4			0.173	
F		3.8			0.150	
G	3		3.2	0.118		0.126
H			2.54			0.100
H2		2.15			0.084	
I		1.27			0.05	
O		0.3			0.011	
V		10°			10°	

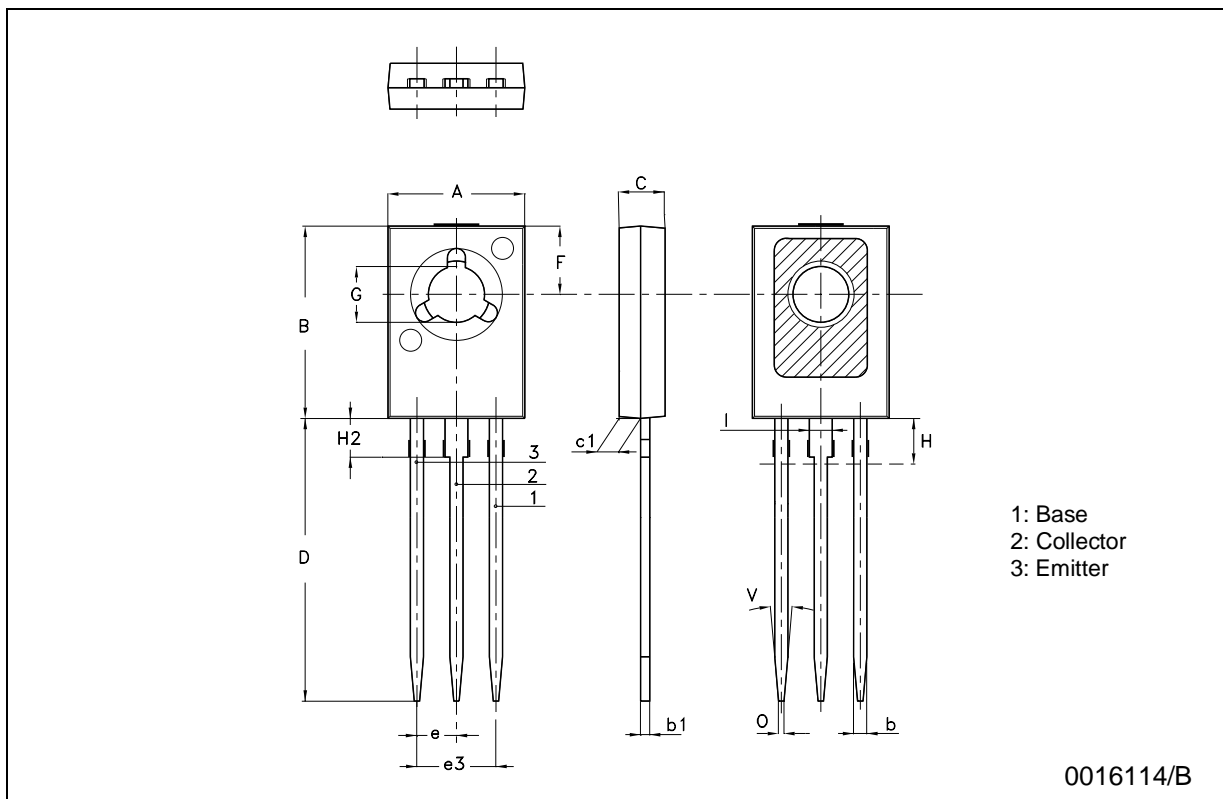

Information furnished is believed to be accurate and reliable. However, STMicroelectronics assumes no responsibility for the consequences of use of such information nor for any infringement of patents or other rights of third parties which may result from its use. No license is granted by implication or otherwise under any patent or patent rights of STMicroelectronics. Specification mentioned in this publication are subject to change without notice. This publication supersedes and replaces all information previously supplied. STMicroelectronics products are not authorized for use as critical components in life support devices or systems without express written approval of STMicroelectronics.

The ST logo is a trademark of STMicroelectronics

© 2001 STMicroelectronics – Printed in Italy – All Rights Reserved

STMicroelectronics GROUP OF COMPANIES

Australia - Brazil - Canada - China - Finland - France - Germany - Hong Kong - India - Israel - Italy - Japan - Malaysia - Malta - Morocco - Singapore - Spain - Sweden - Switzerland - United Kingdom - United States.

<http://www.st.com>