

Datasheet SHTC1

Humidity and Temperature Sensor IC

- Best performance-to-price ratio
- Fully calibrated and reflow solderable
- Ultra-low power consumption
- Power-up and measurement within 1 ms
- 1.8 V supply voltage
- Ultra-small DFN package: 2 × 2 × 0.75 mm³
- Typical accuracy: ±3 %RH and ±0.3 °C



Product Summary

The SHTC1 is a digital humidity and temperature sensor designed especially for high-volume consumer electronics applications. This sensor is strictly designed to overcome conventional limits for size, power consumption, and performance to price ratio in order to fulfill current and future requirements. Sensirion's CMOSens® technology offers a complete sensor system on a single chip, consisting of a capacitive humidity sensor, a bandgap temperature sensor, analog and digital signal processing, A/D converter, calibration data memory, and a digital communication interface supporting I²C fast mode. The ultra-small, 2 × 2 × 0.75 mm³ DFN package enables applications in even the most limited of spaces.

The sensor covers a humidity measurement range of 0 to 100 %RH and a temperature measurement range of –30 to 100 °C with a typical accuracy of ±3 %RH and ±0.3°C. The operation voltage of 1.8 V and an energy budget below 1 µJ per measurement make the SHTC1 suitable for mobile or wireless applications running on the tightest power budgets. With the industry-proven quality and reliability of Sensirion's humidity and temperature sensors and constant accuracy over a large measurement range, the SHTC1 offers an unprecedented performance-to-price ratio. Tape and reel packaging together with suitability for standard SMD assembly processes make the SHTC1 predestined for high-volume applications.

Benefits of Sensirion's CMOSens® Technology

- High reliability and long-term stability
- Industry-proven technology with a track record of more than 10 years
- Designed for mass production
- Optimized for lowest cost
- Low signal noise

Contents of this Data Sheet

1	Humidity and Temperature Sensor Specifications	2
2	Electrical Specifications	3
3	Timing Specifications	4
4	Interface Specifications	6
5	Operation and Communication	6
6	Quality	9
7	Packaging and Traceability	9
8	Ordering Information	9
9	Technical Drawings	10
10	Further Information	12
	Important Notices	14

Block diagram

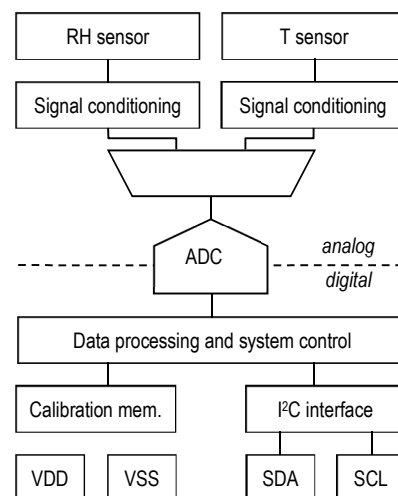

Figure 1 Functional block diagram of the SHTC1.

1 Humidity and Temperature Sensor Specifications

Relative Humidity

Parameter	Conditions	Value	Units
Accuracy tolerance ¹	Typ.	±3.0	%RH
	Max.	see Figure 2	%RH
Repeatability ²	-	0.1	%RH
Resolution ³	-	0.01	%RH
Hysteresis	-	±1	%RH
Specified range ⁴	extended ⁵	0 to 100	%RH
Response time ⁶	τ 63%	8	s
Long-term drift ⁷	Typ.	<0.25	%RH/y

Table 1 Humidity sensor specifications.

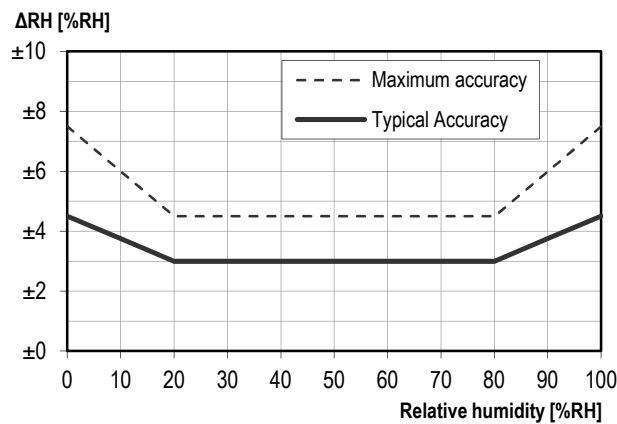

Figure 2 Typical and maximal tolerance for relative humidity in %RH at 25 °C.

Temperature

Parameter	Conditions	Value	Units
Accuracy tolerance ¹	Typ.	±0.3	°C
	Max.	see Figure 3	°C
Repeatability ²	-	0.1	°C
Resolution ³	-	0.01	°C
Specified range ⁴	-	-30 to +100	°C
Response time ⁸	τ 63%	<5 to 30	s
Long-term drift ⁹	Typ.	<0.02	°C/y

Table 2 Temperature sensor specifications.

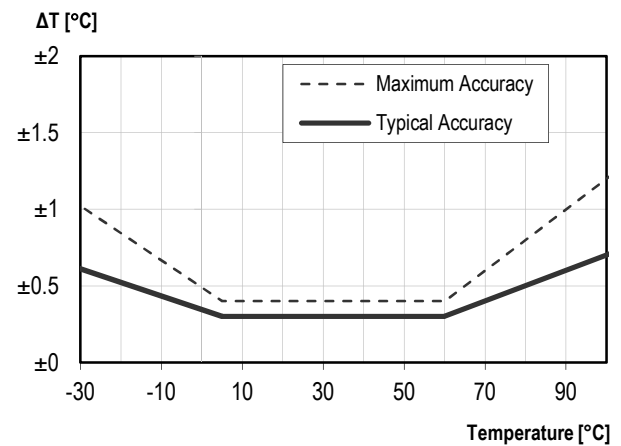

Figure 3 Typical and maximal tolerance for temperature sensor in °C.

¹ For definition of typ. and max. accuracy tolerance, please refer to the document "Sensirion Humidity Sensor Specification Statement".

² The stated repeatability is 3 times the standard deviation (3σ) of multiple consecutive measurement values at constant conditions and is a measure for the noise on the physical sensor output.

³ Resolution of A/D converter.

⁴ Specified range refers to the range for which the humidity or temperature sensor specification is guaranteed.

⁵ For details about recommended humidity and temperature operating range, please refer to section 1.1.

⁶ Time for achieving 63% of a humidity step function, valid at 25°C and 1 m/s airflow. Humidity response time in the application depends on the design-in of the sensor.

⁷ Typical value for operation in normal RH/T operating range. Max. value is < 0.5 %RH/y. Value may be higher in environments with vaporized solvents, out-gassing tapes, adhesives, packaging materials, etc. For more details please refer to Handling Instructions.

⁸ Temperature response time depends on heat conductivity of sensor substrate and design-in of sensor in application.

⁹ Max. value is < 0.04°C/y.

1.1 RH Accuracy at Various Temperatures

Typical RH accuracy at 25°C is defined in Figure 2. For other temperatures, typical accuracy has been evaluated to be as displayed in Figure 4.

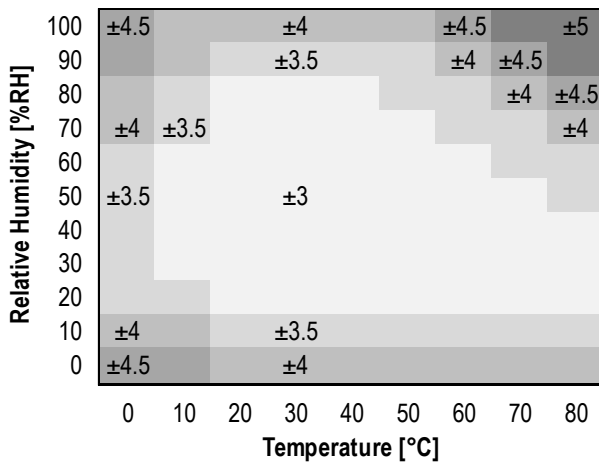

Figure 4 Typical accuracy of relative humidity measurements given in %RH for temperatures 0 – 80°C.

1.2 Recommended Operating Conditions

The sensor shows best performance when operated within recommended normal temperature and humidity range of 5 – 60 °C and 20 – 80 %RH, respectively. Long term exposure to conditions outside normal range, especially at high humidity, may temporarily offset the RH signal (e.g. +3%RH after 60h at >80%RH). After returning into the normal temperature and humidity range the sensor will slowly come back to calibration state by itself. Prolonged exposure to extreme conditions may accelerate ageing.

To ensure stable operation of the humidity sensor, the conditions described in the document “SHTxx Assembly of SMD Packages”, section “Storage and Handling Instructions” regarding exposure to volatile organic compounds have to be met. Please note as well that this does apply not only to transportation and manufacturing, but also to operation of the SHTC1.

2 Electrical Specifications

2.1 Electrical Characteristics

Default conditions of 25 °C and 1.8 V supply voltage apply to values in the table below, unless otherwise stated.

Parameter	Symbol	Conditions	Min	Typ.	Max	Units	Comments
Supply voltage	V _{DD}		1.62	1.8	1.98	V	-
Power-up/down level	V _{POR}	Static power supply	1.05	1.2	1.35	V	-
Supply current	I _{DD}	Idle state	-	0.7	1.5	µA	-
		Measurement	-	385	465	µA	Average current consumption while sensor is measuring ¹⁰
		Average	-	4.8	-	µA	Average current consumption (continuous operation with one measurement per second) ¹⁰
Average power consumption	-	Average	-	8.6	-	µW	Average power consumption (continuous operation with one measurement per second) ¹⁰
Low level input voltage	V _{IL}	-	-0.5		0.3 V _{DD}	V	-
High level input voltage	V _{IH}	-	0.7 V _{DD}		V _{DD(max)} + 0.5	V	-
Low level output voltage	V _{OL}	3 mA sink current	-	-	0.2 V _{DD}	-	-

Table 3 Electrical specifications.

¹⁰ These values can be reduced by using the low power measurement mode, see separate application note.

2.2 Absolute Maximum Ratings

Stress levels beyond those listed in Table 4 may cause permanent damage to the device. These are stress ratings only and functional operation of the device at these conditions cannot be guaranteed. Exposure to the absolute maximum rating conditions for extended periods may affect the reliability of the device.

Parameter	Rating
Supply voltage, V_{DD}	-0.3 to +2.16 V
Operating temperature range	-40 to +125 °C
Storage temperature range ¹¹	-40 to +125 °C
ESD HBM	2 kV
ESD MM	200 V
ESD CDM	500 V
Latch up, JEDEC Class II, 125°C	100mA

Table 4 Absolute maximum ratings.

3 Timing Specifications

3.1 Sensor System Timings

Default conditions of 25 °C and 1.8 V supply voltage apply to values the table below, unless otherwise stated. Max. values are measured at -30°C and 1.98V supply voltage.

Parameter	Symbol	Conditions	Min.	Typ.	Max.	Units	Comments
Power-up time	t_{PU}	After hard reset, $V_{DD} \geq V_{POR}$	-	182	239	μs	Time between V_{DD} reaching V_{PU} and sensor entering idle state
Soft reset time	t_{SR}	After soft reset.	-	173	230	μs	Time between ACK of soft reset command and sensor entering idle state
Measurement duration	t_{MEAS}	-	-	10.8	14.4	ms	Duration for a humidity and temperature measurement ¹²

Table 5 System timing specifications.

¹¹ The recommended storage temperature range is 10-50°C. Please consult the document "SHTxx Handling Instructions" for more information.

¹² These values can be reduced by using the low power measurement mode, see separate application note.

3.2 Communication Timings

Default conditions of 25 °C and 1.8 V supply voltage apply to values in the table below, unless otherwise stated.

Parameter	Symbol	Conditions	Min.	Typ.	Max.	Units	Comments
SCL clock frequency	f_{SCL}	-	0	-	400	kHz	-
Hold time (repeated) START condition	$t_{HD,STA}$	After this period, the first clock pulse is generated	0.6	-	-	μs	-
LOW period of the SCL clock	t_{LOW}	-	1.3	-	-	μs	-
HIGH period of the SCL clock	t_{HIGH}	-	0.6	-	-	μs	-
Set-up time for a repeated START condition	$t_{SU,STA}$	-	0.6	-	-	μs	-
SDA hold time	$t_{HD,DAT}$	-	0	-	-	-	-
SDA set-up time	$t_{SU,DAT}$	-	100	-	-	ns	-
SCL/SDA rise time	t_R	-	20	-	300	ns	-
SCL/SDA fall time	t_F	-	20 * ($V_{DD}/5.5$)	-	300	ns	-
SDA valid time	$t_{VD,DAT}$	-	-	-	0.9	μs	-
Set-up time for STOP condition	$t_{SU,STO}$	-	0.6	-	-	μs	-
Capacitive load on bus line	C_B	-	-	-	400	pF	-

Table 6 Communication timing specifications. The numbers above are values according to the I²C specification.

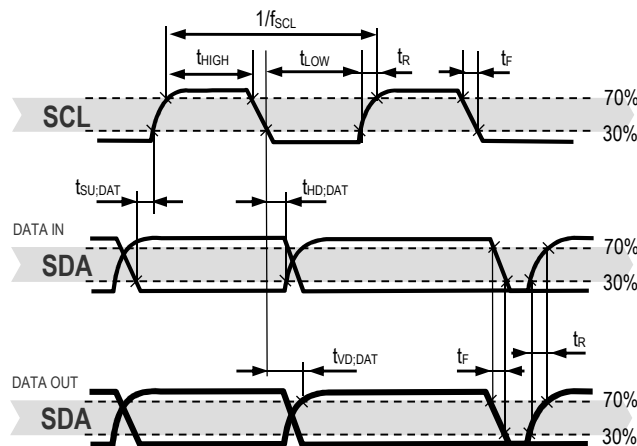

Figure 5 Timing diagram for digital input/output pads. SDA directions are seen from the sensor. Bold SDA lines are controlled by the sensor, plain SDA lines are controlled by the micro-controller. Note that SDA valid read time is triggered by falling edge of preceding toggle.

4 Interface Specifications

The SHTC1 supports I²C fast mode (SCL clock frequency from 0 to 400 kHz) with clock stretching. For detailed information on the I²C protocol, refer to NXP I²C-bus specification and user manual UM10204, Rev. 4, February 13, 2012:

http://ics.nxp.com/support/documents/interface/pdf/I2C_bu_s.specification.pdf

The SHTC1 comes in a 4-pin package – see Table 7.

Pin	Name	Comments
1	VDD	Supply voltage
2	SCL	Serial clock, bidirectional
3	SDA	Serial data, bidirectional
4	VSS	Ground

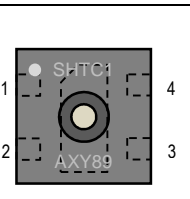

Table 7 SHTC1 pin assignment (top view). The center pad is internally connected to VSS.

Power-supply pins supply voltage (VDD) and ground (VSS) must be decoupled with a 100 nF capacitor that shall be placed as close to the sensor as possible – see Figure 6.

SCL is used to synchronize the communication between microcontroller and the sensor. The master must keep the clock frequency within 0 to 400 kHz as specified in Table 6. The SHTC1 may pull down the SCL line when clock stretching is enabled.

The SDA pin is used to transfer data in and out of the sensor. For safe communication, the timing specifications defined in the I²C manual must be met.

To avoid signal contention, the microcontroller must only drive SDA and SCL low. External pull-up resistors (e.g. 10 k Ω) are required to pull the signal high. For dimensioning resistor sizes please take bus capacity requirements into account. It should be noted that pull-up resistors may be included in I/O circuits of microcontrollers.

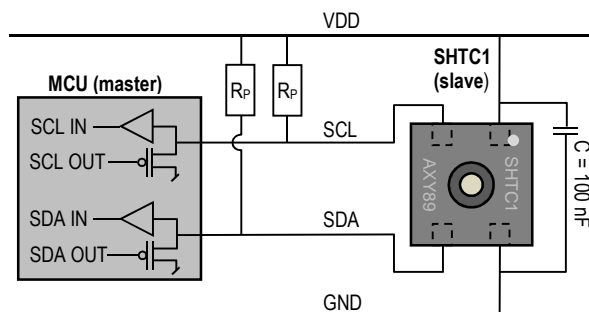

Figure 6 Typical application circuit, including pull-up resistors R_p and decoupling of VDD and VSS by a capacitor.

For good performance of the SHTC1 in the application, it is important to know that the center pad of the SHTC1 offers the best thermal contact to the temperature sensor. For more information on design-in, please refer to the document “SHTxx Design Guide”.

For mechanical reasons the center pad should be soldered. Electrically, the center pad is internally connected to GND and may be connected to the GND net on the PCB or left floating.

5 Operation and Communication

All commands and memory locations of the SHTC1 are mapped to a 16-bit address space which can be accessed via the I²C protocol.

SHTC1	Bin.	Dec.	Hex.
I ² C address	111'0000	112	0x70

Table 8 SHTC1 I²C device address.

5.1 Power-Up and Communication Start

Upon VDD reaching the power-up voltage level V_{POR} , the SHTC1 enters idle state after a duration of t_{PU} . In idle state, the SHTC1 is ready to receive commands from the master (microcontroller).

Each transmission sequence begins with START condition (S) and ends with an (optional) STOP condition (P) as described in the I²C-bus specification. Whenever the sensor is powered up, but not performing a measurement or communicating, it automatically enters idle state for energy saving.

Please note that in case VDD is set to 0 V (GND), e.g. in case of a power off of the SHTC1, the SCL and SDA pads are also pulled to GND. Consequently, the I²C bus is blocked while VDD of the SHTC1 is set to 0 V.

5.2 Measurement Commands

The SHTC1 provides the possibility to define the sensor behavior during measurement as well as the transmission sequence of measurement results. These characteristics are defined by the appropriate measurement command (see Table 9). Each measurement command triggers both a temperature *and* a humidity measurement.

Clock Stretching Enabled		Clock Stretching Disabled	
Read T First	Read H First	Read T First	Read H First
0x7CA2	0x5C24	0x7866	0x58E0

Table 9 Measurement commands.

5.3 Starting a Measurement

A measurement communication sequence consists of a START condition followed by the I²C header with the 7-bit I²C device address and a write bit (write W: '0'). The sensor indicates the proper reception of a byte by pulling the SDA pin low (ACK bit) after the falling edge of the 8th SCL clock. Then the sensor is ready to receive a 16-bit measurement command. Again, the SHTC1 acknowledges the proper reception of each byte with ACK condition. A complete measurement cycle is presented in Figure 7.

With the acknowledgement of the measurement command, the SHTC1 starts measuring humidity and temperature.

5.4 Sensor Behavior during Measurement and Clock Stretching

In general, the sensor does not respond to any I²C activity during measurement, i.e. I²C read and write headers are not acknowledged (NACK). However, when clock stretching has been enabled by using a corresponding measurement command, the sensor responds to a read header with an ACK and subsequently pulls down the SCL line until the measurement is complete. As soon as the measurement is complete, the sensor starts sending the measurement results.

During measurement, the sensor has a current consumption according to Table 3.

For best possible repeatability of humidity and temperature measurements, it is recommended to avoid any communication on the I²C bus while the SHTC1 is measuring. For more information, see application note "SHTC1 Optimization of Repeatability".

5.5 Readout of Measurement Results

After a measurement command has been issued and the sensor has completed the measurement, the master can read the measurement results by sending a START condition followed by an I²C read header. The sensor will acknowledge the reception of the read header and send two bytes of data followed by one byte CRC checksum and another two bytes of data followed by one byte CRC checksum. Each byte must be acknowledged by the microcontroller with an ACK condition for the sensor to continue sending data. If the SHTC1 does not receive an ACK from the master after any byte of data, it will not continue sending data.

Whether the sensor sends out humidity or temperature data first depends on the measurement command that was sent to the sensor to initiate the measurement (see Table 9).

The I²C master can abort the read transfer with a NACK condition after any data byte if it is not interested in subsequent data, e.g. the CRC byte or the second measurement result, in order to save time.

In case the user needs humidity and temperature data but does not want to process CRC data, it is recommended to

read the first two bytes of data with the CRC byte (without processing the CRC data) and abort the read transfer after reading the second two data bytes with a NACK. This procedure is more time efficient than starting two different measurements and aborting the read transfer after the first two data bytes each time.

5.6 Soft Reset

The SHTC1 provides a soft reset mechanism that forces the system into a well-defined state without removing the power supply. If the system is in idle state (i.e. if no measurement is in progress) the soft reset command can be sent to SHTC1 according to Figure 8. This triggers the sensor to reset all internal state machines and reload calibration data from the memory.

Command	Hex. Code	Bin. Code
Software reset	0x805D	1000'0000'0101'1101

Table 10 Soft reset command.

5.7 Read-out of ID Register

The SHTC1 has an ID register which contains an SHTC1-specific product code. The read-out of the ID register can be used to verify the presence of the sensor and proper communication. The command to read the ID register is shown in Table 11.

Command	Hex. Code	Bin. Code
Read ID register	0xEFC8	1110'1111'1100'1000

Table 11 Read-out command of ID register.

It needs to be sent to the SHTC1 after an I²C write header. After the SHTC1 has acknowledged the proper reception of the command, the master can send an I²C read header and the SHTC1 will submit the 16-bit ID followed by 8 bits of CRC. The structure of the ID is described in Table 12.

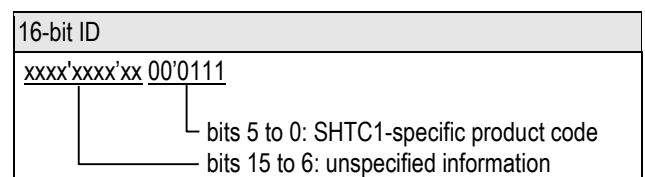

Table 12 Structure of the 16-bit ID. Bits 15:6 of the ID contain unspecified information (marked as "x"), which may vary from sensor to sensor, while bits 5:0 contain the SHTC1-specific product code.

5.8 Checksum Calculation

The 8-bit CRC checksum transmitted after each data word is generated by a CRC algorithm with the properties displayed in Table 13. The CRC covers the contents of the two previously transmitted data bytes.

Property	Value
Name	CRC-8
Width	8 bits
Polynomial	0x31 ($x^8 + x^5 + x^4 + 1$)
Initialization	0xFF
Reflect input	False
Reflect output	False
Final XOR	0x00
Examples	CRC (0x00) = 0xAC CRC (0xBEEF) = 0x92

Table 13 SHTC1 I²C CRC properties.

compensated by the SHTC1. Humidity and temperature values can be calculated with the formulas in given below.

Relative humidity conversion formula (result in %RH):

$$RH = 100 \cdot \frac{S_{RH}}{2^{16}}$$

Temperature conversion formula (result in °C):

$$T = -45 + 175 \cdot \frac{S_T}{2^{16}}$$

S_{RH} and S_T denote the raw sensor output (as decimal values) for humidity and temperature, respectively.

5.9 Conversion of Sensor Output

Measurement data is always transferred as 16-bit values. These values are already linearized and temperature

5.10 Communication Data Sequences

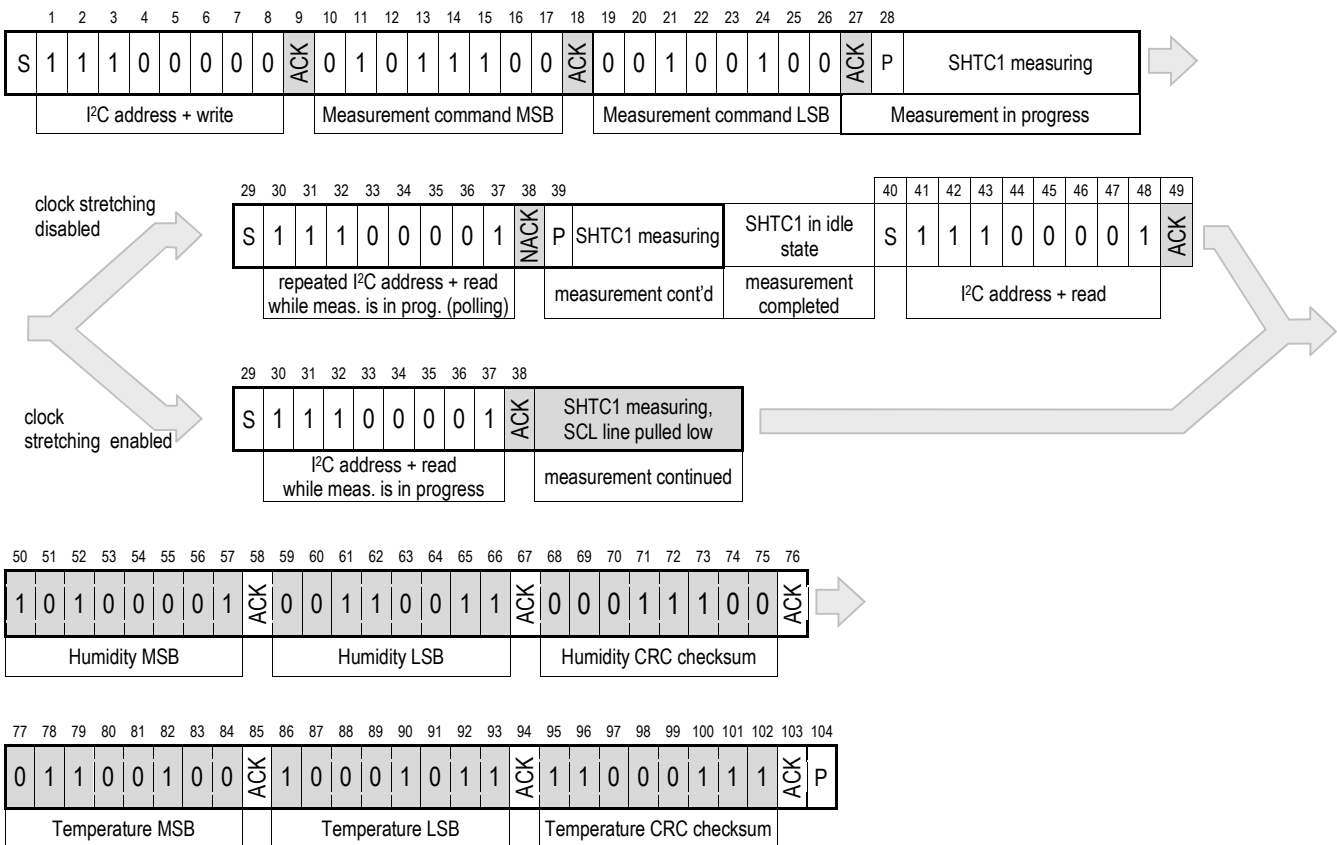

Figure 7 Communication sequence for starting a measurement and reading measurement results displaying both clock stretching options. The numerical example corresponds to a read humidity-first command with clock stretching enabled. The physical values of the transmitted measurement results are 62.9 %RH and 23.7 °C. Clear blocks are controlled by the microcontroller, grey blocks by the SHTC1.

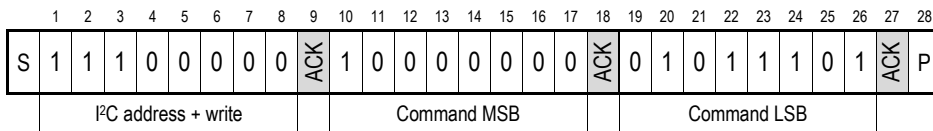

Figure 8 Command access communication sequence. The example shows a soft reset command. Clear blocks are controlled by the microcontroller, grey blocks by the SHTC1.

6 Quality

6.1 Environmental Stability

Qualification of the SHTC1 is performed based on the JEDEC JESD47 qualification test method.

6.2 Material Contents

The device is fully RoHS and WEEE compliant, e.g. free of Pb, Cd, and Hg.

7 Packaging and Traceability

SHTC1 sensors are provided in a DFN package with an outline of $2 \times 2 \times 0.75 \text{ mm}^3$ and a terminal pitch of 1 mm. DFN stands for dual flat no leads. The humidity sensor opening is centered on the top side of the package.

The sensor chip is made of silicon and is mounted to a lead frame. The latter is made of Cu plated with Ni/Pd/Au. Chip and lead frame are overmolded by a green epoxy-based mold compound. Please note that the side walls of sensor are diced and therefore these diced lead frame surfaces are not covered with the respective plating.

The Moisture Sensitivity Level classification of the SHTC1 is MSL1, according to IPC/JEDEC J-STD-020.

All SHTC1 sensors are laser marked for easy identification and traceability. The marking on the sensor consists of two lines and a pin-1 indicator. The top line contains the sensor type (SHTC1), the bottom line contains a 5-digit,

alphanumeric tracking code. The pin-1 indicator is located in the top left corner. See Figure 9 for illustration.

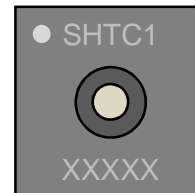

Figure 9 Laser marking on SHTC1, the top line with the pin-1 indicator and the sensor type, the bottom line with the 5-digit alphanumeric tracking code.

Reels are also labeled and provide additional traceability information.

8 Ordering Information

The SHTC1 can be ordered in tape and reel packaging with different sizes, see Table 14. The reels are sealed into antistatic ESD bags. A drawing of the packaging tape with sensor orientation is shown in Figure 12.

Quantity	Packaging	Reel Diameter	Order Number
1'000	Tape & Reel	180 mm (7 inch)	1-101110-01
10'000	Tape & Reel	330 mm (13 inch)	1-100925-01

Table 14 SHTC1 ordering options.

9 Technical Drawings

9.1 Package Outline

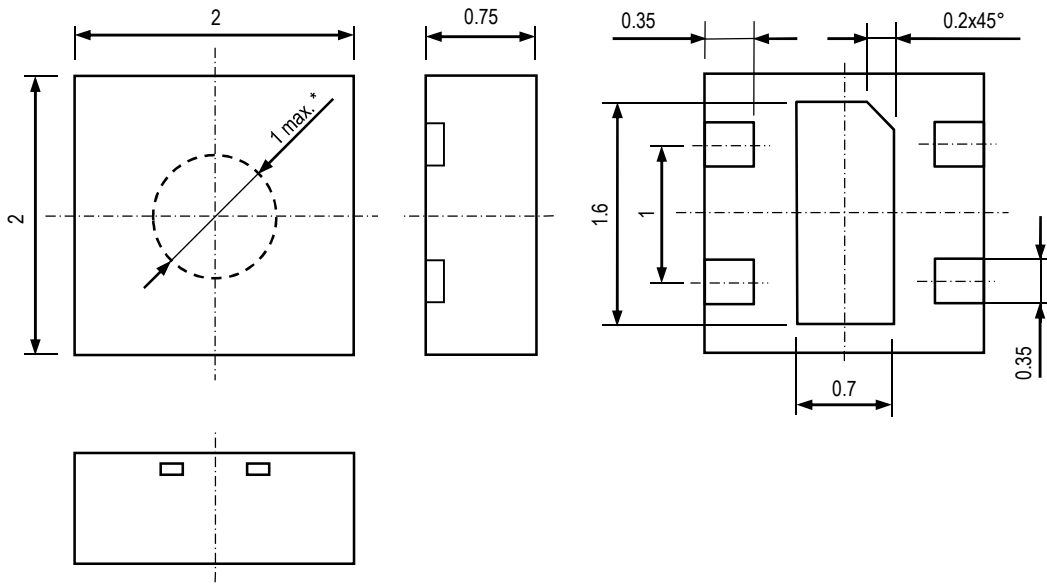

* Mold opening shows smooth transition to package surface. Therefore this dimension is not well defined and given for reference only.

Figure 10 Package outline drawing of the SHTC1. Dimensions are given in millimeters.

9.2 Metal Land Pattern

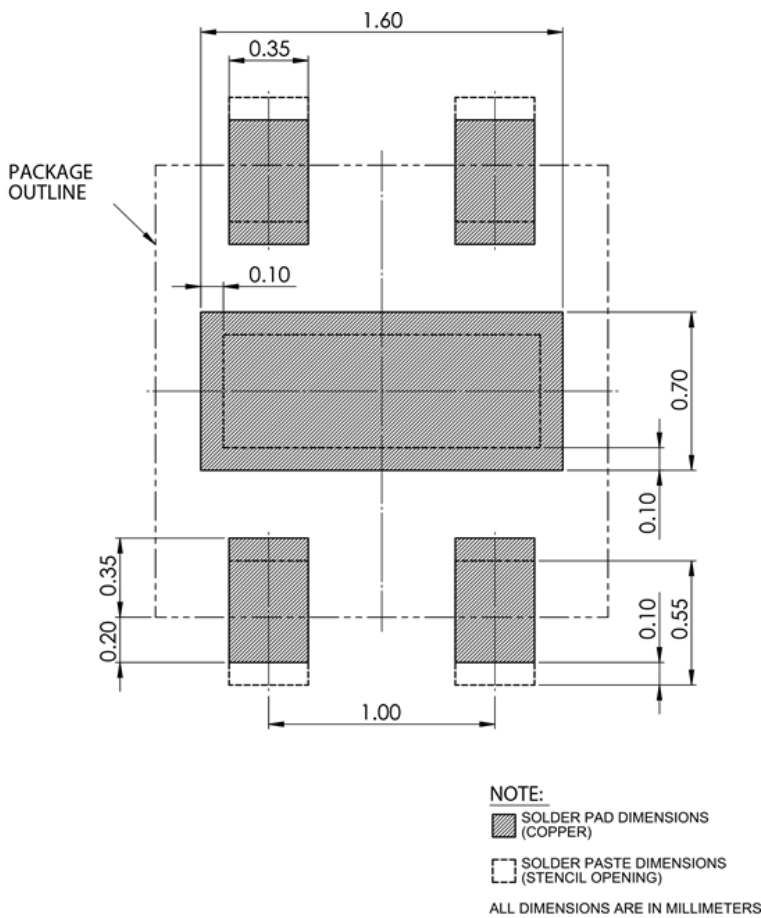

Figure 11 Recommended metal land pattern for SHTC1 (all dimensions are in mm). Recommended solder paste stencil thickness is 100µm, pads on PCB are recommended to be non solder mask defined (NSMD).

9.3 Tape and Reel Package

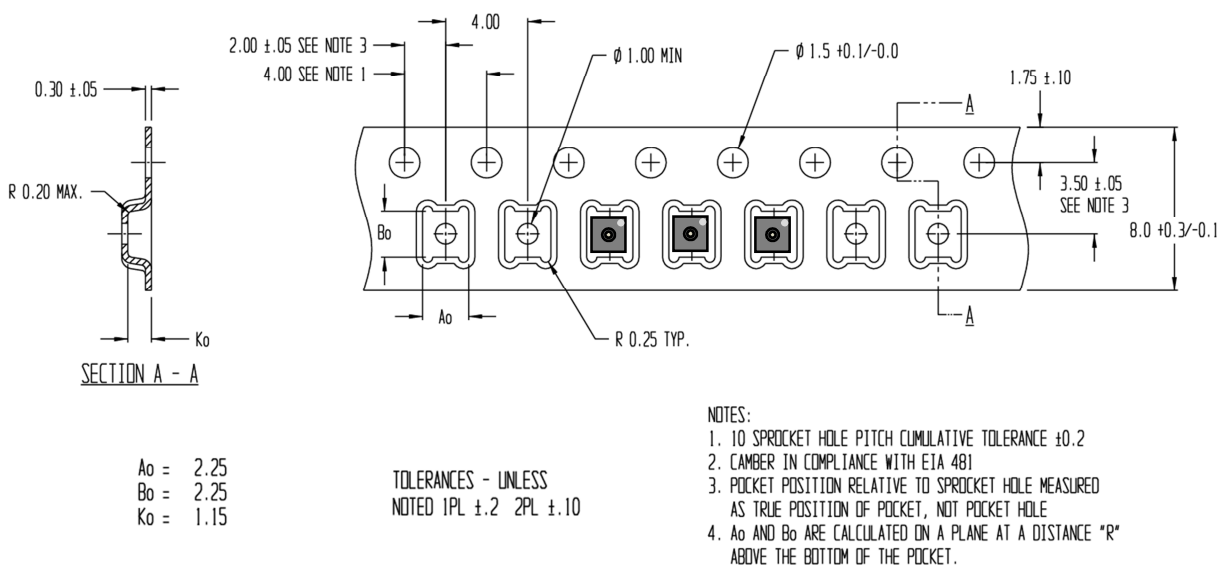

Figure 12 Technical drawing of the packaging tape with sensor orientation in tape. Header tape is to the right and trailer tape to the left on this drawing. Dimensions are given in millimeters.

10 Further Information

For more in-depth information on the SHTC1 and its application please consult the following documents:

Document Name	Description	Source
SHTxx Assembly of SMD Packages	Instructions on soldering and processing of the SHTC1 in a production environment	Available for download from the SHTC1 product website: www.sensirion.com/shtc1
SHTC1 Optimization of Repeatability	Measures for optimization of repeatability of sensor output.	Available for download from the SHTC1 product website: www.sensirion.com/shtc1
SHTC1 Low Power Measurement Mode	Description of SHTC1 low power measurement mode.	Available for download from the SHTC1 product website: www.sensirion.com/shtc1
SHTxx Design Guide	Design guidelines for designing SHTxx humidity sensors into applications	Available for download at the Sensirion humidity sensors download center: www.sensirion.com/humidity-download
SHTxx Handling Instructions	Guidelines for proper handling of SHTxx humidity sensors	Available for download at the Sensirion humidity sensors download center: www.sensirion.com/humidity-download
Sensirion Humidity Sensor Specification Statement	Definition of sensor specifications.	Available for download at the Sensirion humidity sensors download center: www.sensirion.com/humidity-download

Table 15 Documents containing further information relevant for the SHTC1.

Revision History

Date	Version	Page(s)	Changes
February 21, 2013	1	all	Initial version
May 21, 2013	2	6, 8	Section 5.2.1 removed, stop condition added to fig. 6
May 23, 2014	3	1-4, 7, 9, 11-12	RH accuracy at various temperatures added, MSL added, ordering information added, metal land pattern added, minor adjustments.
26. August 2015	4	3	Improved max.idle current.

Important Notices

Warning, Personal Injury

Do not use this product as safety or emergency stop devices or in any other application where failure of the product could result in personal injury. Do not use this product for applications other than its intended and authorized use. Before installing, handling, using or servicing this product, please consult the data sheet and application notes. Failure to comply with these instructions could result in death or serious injury.

If the Buyer shall purchase or use SENSIRION products for any unintended or unauthorized application, Buyer shall defend, indemnify and hold harmless SENSIRION and its officers, employees, subsidiaries, affiliates and distributors against all claims, costs, damages and expenses, and reasonable attorney fees arising out of, directly or indirectly, any claim of personal injury or death associated with such unintended or unauthorized use, even if SENSIRION shall be allegedly negligent with respect to the design or the manufacture of the product.

ESD Precautions

The inherent design of this component causes it to be sensitive to electrostatic discharge (ESD). To prevent ESD-induced damage and/or degradation, take customary and statutory ESD precautions when handling this product.

See application note "ESD, Latchup and EMC" for more information.

Warranty

SENSIRION warrants solely to the original purchaser of this product for a period of 12 months (one year) from the date of delivery that this product shall be of the quality, material and workmanship defined in SENSIRION's published specifications of the product. Within such period, if proven to be defective, SENSIRION shall repair and/or replace this product, in SENSIRION's discretion, free of charge to the Buyer, provided that:

- notice in writing describing the defects shall be given to SENSIRION within fourteen (14) days after their appearance;

- such defects shall be found, to SENSIRION's reasonable satisfaction, to have arisen from SENSIRION's faulty design, material, or workmanship;
- the defective product shall be returned to SENSIRION's factory at the Buyer's expense; and
- the warranty period for any repaired or replaced product shall be limited to the unexpired portion of the original period.

This warranty does not apply to any equipment which has not been installed and used within the specifications recommended by SENSIRION for the intended and proper use of the equipment. EXCEPT FOR THE WARRANTIES EXPRESSLY SET FORTH HEREIN, SENSIRION MAKES NO WARRANTIES, EITHER EXPRESS OR IMPLIED, WITH RESPECT TO THE PRODUCT. ANY AND ALL WARRANTIES, INCLUDING WITHOUT LIMITATION, WARRANTIES OF MERCHANTABILITY OR FITNESS FOR A PARTICULAR PURPOSE, ARE EXPRESSLY EXCLUDED AND DECLINED.

SENSIRION is only liable for defects of this product arising under the conditions of operation provided for in the data sheet and proper use of the goods. SENSIRION explicitly disclaims all warranties, express or implied, for any period during which the goods are operated or stored not in accordance with the technical specifications.

SENSIRION does not assume any liability arising out of any application or use of any product or circuit and specifically disclaims any and all liability, including without limitation consequential or incidental damages. All operating parameters, including without limitation recommended parameters, must be validated for each customer's applications by customer's technical experts. Recommended parameters can and do vary in different applications.

SENSIRION reserves the right, without further notice, (i) to change the product specifications and/or the information in this document and (ii) to improve reliability, functions and design of this product.

Copyright © 2014, by SENSIRION.
CMOSens® is a trademark of Sensirion
All rights reserved

Headquarters and Subsidiaries

Sensirion AG
Laubisruetistr. 50
CH-8712 Staefa ZH
Switzerland

Phone: +41 44 306 40 00
Fax: +41 44 306 40 30
info@sensirion.com
www.sensirion.com

Sensirion AG (Germany)
Phone: +41 44 927 11 66
info@sensirion.com
www.sensirion.com

Sensirion Inc., USA
Phone: +1 805 409 4900
info_us@sensirion.com
www.sensirion.com

Sensirion Japan Co. Ltd.
Phone: +81 3 3444 4940
info@sensirion.co.jp
www.sensirion.co.jp

Sensirion Korea Co. Ltd.
Phone: +82 31 337 7700~3
info@sensirion.co.kr
www.sensirion.co.kr

Sensirion China Co. Ltd.
Phone: +86 755 8252 1501
info@sensirion.com.cn
www.sensirion.com.cn

To find your local representative, please visit www.sensirion.com/contact

Mouser Electronics

Authorized Distributor

Click to View Pricing, Inventory, Delivery & Lifecycle Information:

[Sensirion:](#)

[SHTC1](#)