

# TRB

**TRBS** Coil Terminal Arranged on One Side

## MAIN FEATURES

- Subminiature Type.
- Silver or Silver Alloy Contacts with Gold Plated.
- Low Dissipation.
- Sealed Type Available.
- Design conforms to foreign safety standard UL.
- UL and cUL recognized.

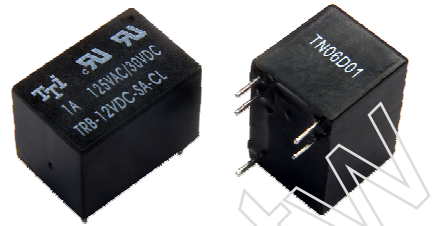

## APPLICATIONS

- Microprocessor Control, Store Program Exchanger and Household Appliance.

## ORDERING INFORMATION

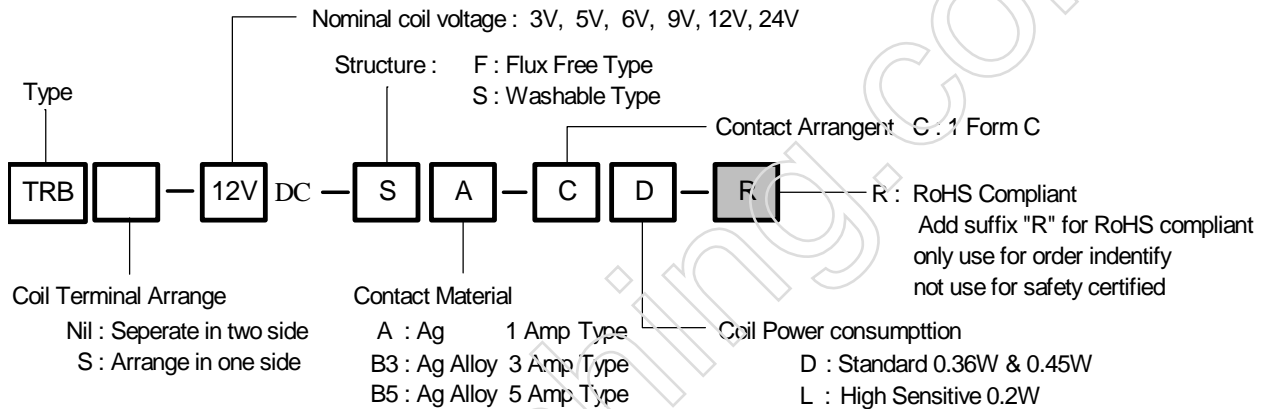

## DIMENSION (unit:mm)

## DRILLING (unit:mm)

## WIRING DIAGRAM

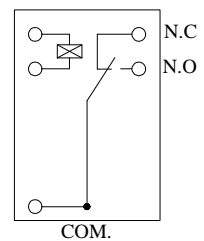
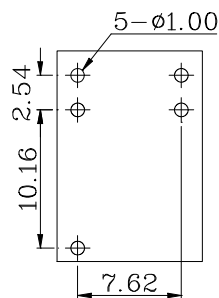
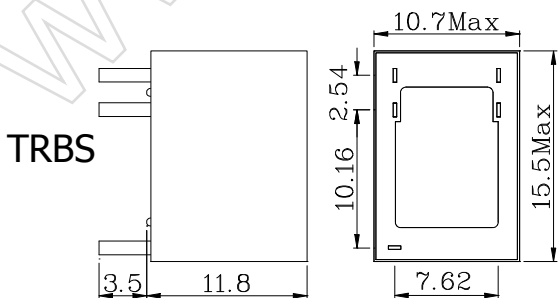
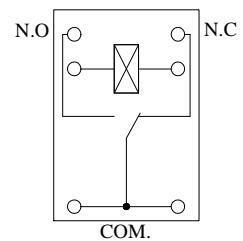
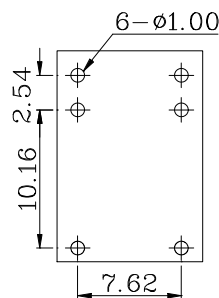
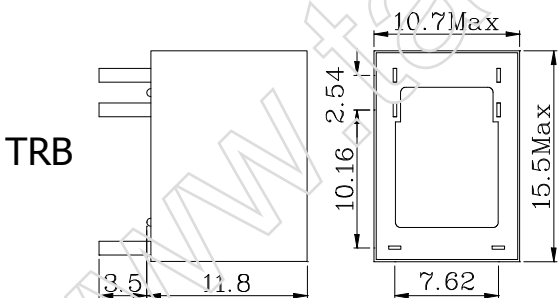

## COIL DATA CHART (AT20°C)

Coil Sensitivity	Coil Voltage Code	Nominal Voltage (VDC)	Nominal Current (mA)	Coil Resistance ( $\Omega$ ) $\pm 10\%$	Power Consumption (W)	Pull-In Voltage (VDC)	Drop-Out Voltage (VDC)	Max-Allowable Voltage (VDC)
TRBS-A (High Sensitivity) 1 Amp type	03	03	66.7	45	abt. 0.2 W	75% Max.	10% Min.	110%
	05	05	40	125				
	06	06	33.3	180				
	09	09	22.2	405				
	12	12	16.7	720				
	24	24	8.3	2880				
TRB-B3 (Standard) 3 Amp type	03	03	120	25	abt. 0.36W	75% Max.	10% Min.	110%
	05	05	66.7	75				
	06	06	60	100				
	09	09	40.9	220				
	12	12	30	400				
	24	24	15	1600				
TRB-B5 (High Capacity) 5 Amp type	03	03	150	20	abt. 0.45W	75% Max.	10% Min.	110%
	05	05	89.3	56				
	06	06	75	80				
	09	09	50	180				
	12	12	37.5	320				
	24	24	18.75	1280				

## CONTACT RATING

Item	Type	TRBS-A	TRB-B3	TRB-B5
		1 Amp type	3 Amp type	5 Amp type
Contact Capacity		Coil = 0.2W	Coil = 0.36W	Coil = 0.45W
Resistive Load ( $\cos\Phi=1$ )		1A 125VAC 1A 30VDC	3A 125VAC 3A 30VDC	5A 125VAC 5A 14VDC
Inductive Load ( $\cos\Phi=0.4$ L/R=7msec)			0.3A 125VAC 0.3A 30VDC	
Rated Carrying Current		1 A	3 A	5 A
Max. Allowable Voltage		125VAC, 30VDC		
Max. Allowable Current		1 A	3 A	5 A
Max. Allowable Power Force		125VA, 30W	375VA, 90W	625VA, 70W
Contact Material		Ag Alloy		

## REFERENCE DATA

Coil Temperature Rise

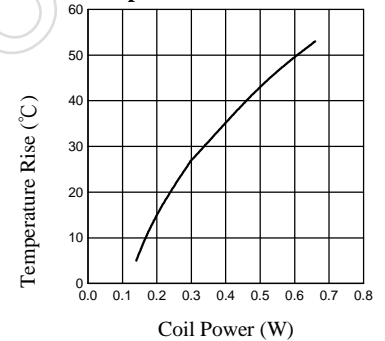

## PERFORMANCE (at initial value)

Item	Type	TRB / TRBS
Contact Resistance		100m $\Omega$ Max.
Operation Time		5msec Max.
Release Time		5msec Max.
Dielectric Strength	Between coil & contact	500VAC 50/60HZ (1 minute)
	Between contacts	500VAC 50/60HZ (1 minute)
Surge Resistiveness		1000V (between coil & contact 1x40u sec)
Insulation Resistance		100 M $\Omega$ Min. (500VDC)
Max. ON/OFF Switching	Mechanically	300 operation/min
	Electrically	30 operation/min
Operating Ambient Temperature		-25°C to +55°C (No water condensation and no water drop)
Operating Humidity		45 to 85% RH
Coil Temperature Rise		40 deg. Max. (at rated coil voltage)
Vibration	Endurance	10 to 55HZ Single Amplitude 0.35mm
	Error Operation	10 to 55HZ Single Amplitude 0.35mm
Shock	Endurance	50G Min.
	Error Operation	10G Min.
Life Expectancy	Mechanically	10 x 10 <sup>6</sup> operations. Min. (no load)
	Electrically	10 x 10 <sup>4</sup> operations. Min. (at rated coil voltage)
Weight		abt. 3.5grs.
UL & cUL		E156521

Operate time

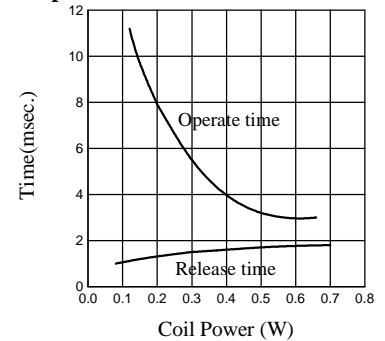

Life Expectancy

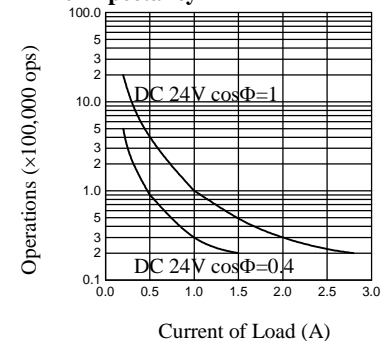

This datasheet for reference and subject to change without notice. Please double check final specification with Tai-Shing.