

REV.	DESCRIPTION	DRAWN	CHECKED	APPROVED
A	NEW RELEASE	LJH 09/24/05'	~	LJC 09/24/05'
B	ADD 50pin drawing	LJC 02/10/07'	~	LJC 06/16/07'
C	ADD BR TYPE	YCH 07/10/07'	~	

NOTES:

- ELECTRICAL CHARACTERISTICS:
 - CONTACT RESISTANCE: 20mΩ Max. INITIAL.
 - DIELECTRIC WITHSTANDING VOLTAGE: 500V AC(rms) FOR 1 MINUTE.
 - INSULATION RESISTANCE: 1000MΩ Min.
 - ENVIRONMENT CHARACTERISTICS:

TEMPERATURE RANGE: -45°C~+105°C.
 - PART NUMBER: DS1033
 - PRODUCT NUMBER CODE:
DS1033- X X X X X X X
- SCREW DIM. A
S: Standard(W/O nut)
1: 5.00
2: 3.00
3: 5.20
4: 4.80
5: 5.80
6: 4.00
- SCREW TYPE
S: Standard(W/O nut)
1: CC TYPE
2: CS TYPE
3: BR TYPE
4: BRJ TYPE DIM. C: 3~4mm
5: BRJ TYPE DIM. C: 5~6mm
- CONTACT PLATING
8: FULL GOLD FLASH
Si: SELECTIVE GOLD FLASH
- SHELL PLATING
T: FRONT & BACK SHELL Tin
N: FRONT SHELL Nickel,
BACK SHELL Tin
- HOUSING COLOR
B: BLACK
W: WHITE
U: BLUE
- CONNECTOR TYPE
M: Male
F: Female
- No.OF CONTACTS
09: 9pos.
15: 15pos.
25: 25pos.
37: 37pos.

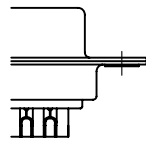
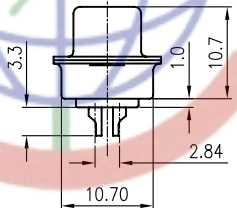
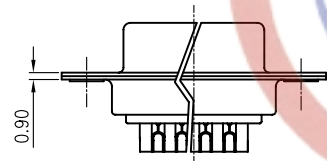
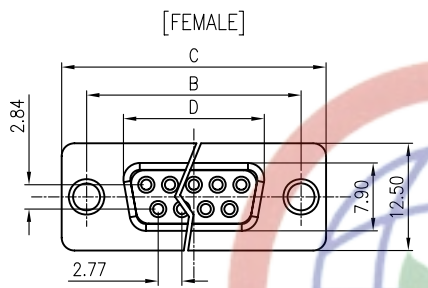

Standard

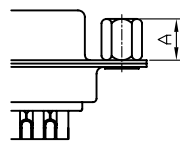

CC TYPE

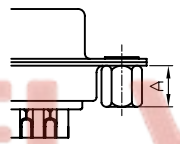

CS TYPE

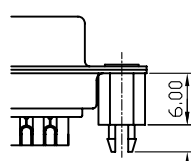

BR TYPE:

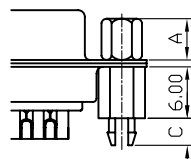

BRJ TYPE:

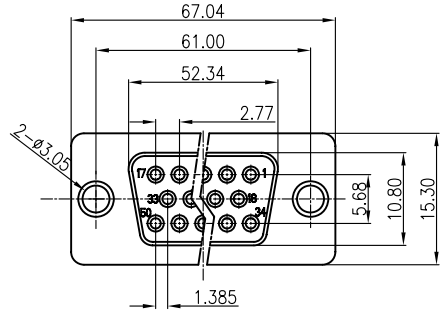

50pin Female Figure

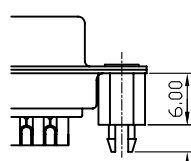
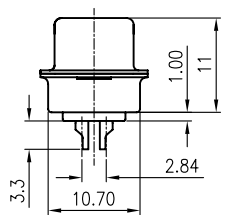
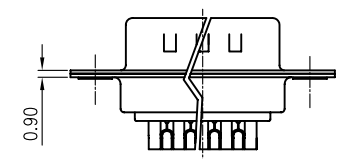
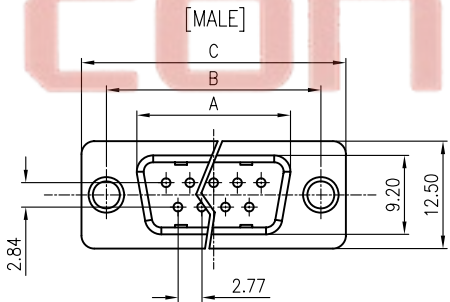

Standard

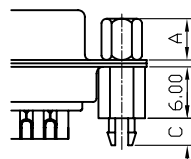

CC TYPE

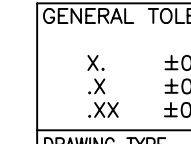

CS TYPE

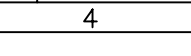

BR TYPE:

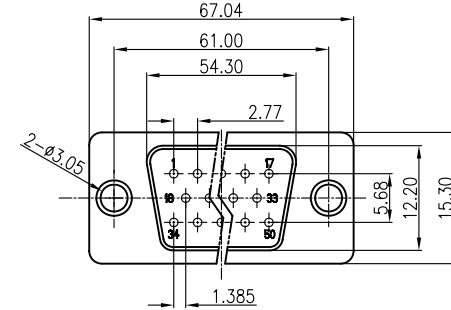

50pin Male Figure

Dimension

Position	A±0.2	B±0.2	C±0.3	D
9	17.90	24.99	30.80	16.33
15	26.50	33.32	39.14	24.66
25	40.00	47.04	53.04	38.38
37	56.50	63.50	69.32	54.84

GENERAL TOLERANCE	ANGLE TOLERANCE
X. ±0.60	X. ±5°
.X ±0.38	.X ±3°
.XX ±0.25	.XX ±2°

PROJECTION	TITLE
UNITS	mm
SHEET SIZE	A4

D-SUB SOLDER TYPE	
SERIES	DS1033 SERIES

DRAWING TYPE	CUSTOMER
SCALE	1:1 SHEET 1 OF 1
DRAWING NO.	C-DS1033-XXXXXXX

晨翔电子有限公司
CONNFLY CONNFLY ELECTRONIC CO. LTD
 Add.: West...
 Tel: 86-574-63508787
 Fax: 86-574-63510817