

| BOM LIST | | | |
|----------|----------------|------|-------|
| ITEM | PART NAME | Q'ty | NOTES |
| 1 | PLASTIC HOOD | 2 | ABS |
| 2 | 2.1 LONG BOLT | 2 | #4-40 |
| | 2.2 SHORT BOLT | 2 | #4-40 |
| 3 | NUT | 2 | M3 |
| 4 | LONG SCREW | 2 | M3 |
| 5 | SMALL WASHER | 2 | M3 |
| 6 | SHORT SCREW | 2 | M3 |
| 7 | METAL WASHER | 2 | M3 |

| REV. | DESCRIPTION | DRAWN | CHECKED | APPROVED |
|------|-----------------|---------------|---------|---------------|
| A | NEW RELEASE | LJH 08/13/05' | ~ | LJC 08/13/05' |
| B | 整理图画 | YCH 09/13/07' | ~ | LJC 05/20/10' |
| C | 改M3*12的螺钉为M3*10 | YCH 08/30/10' | ~ | LJC 08/30/10' |
| D | MINUS P/N CODE | JLZ 12/16/14' | ~ | |

NOTES:

1. PART NUMBER CODE:

DS1046 - 09 X X X X

Washer type (D)
1: Metal

Bolt type
L: Long
S: Short

Packing type
1: Mix packing

Cover Material
C: Chromium plating

Position
09: 9pin

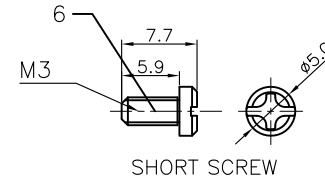
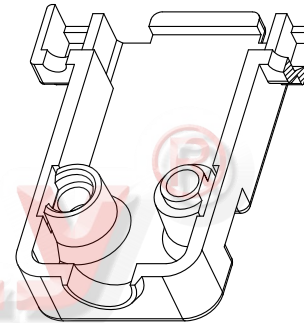
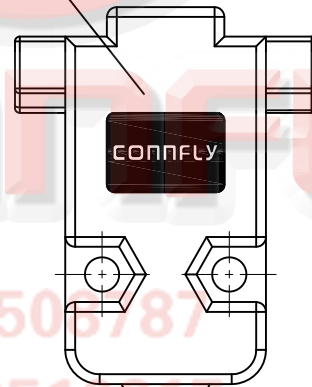
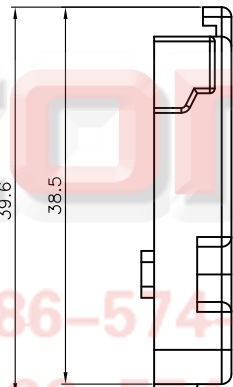
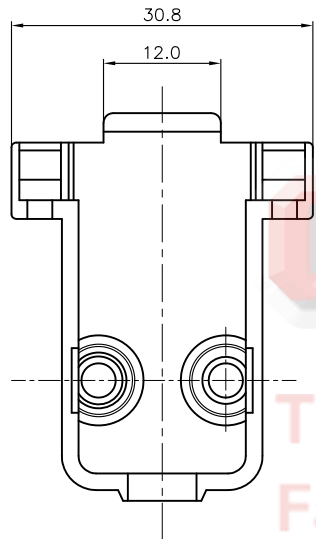
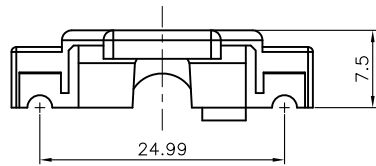

SHORT SCREW

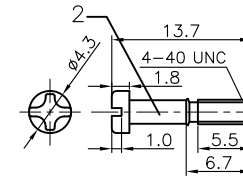

Short BOLT

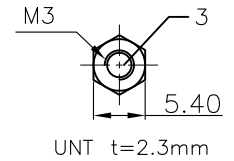

UNT t=2.3mm

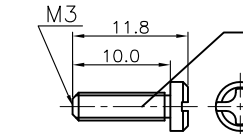

LONG SCREW

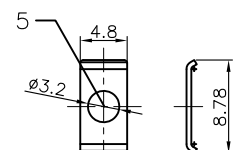

SMALL WASHER

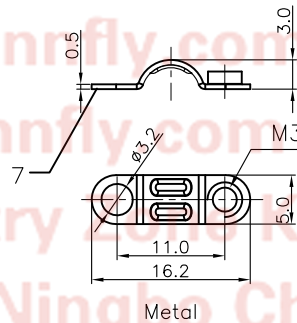
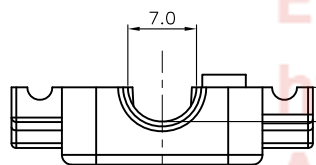

Metal

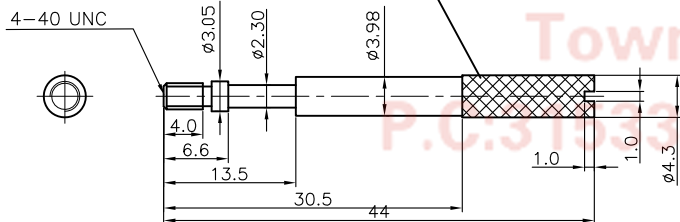

Long BOLT

| GENERAL TOLERANCE | ANGLE TOLERANCE |
|-------------------|-----------------|
| X. ±0.60 | X. ±5° |
| .X ±0.38 | .X ±3° |
| .XX ±0.25 | .XX ±2° |

| PROJECTION | TITLE |
|------------|---------------------------------|
| UNITS | D-SUB 9pin Hood Chromium Plated |
| SHEET SIZE | SERIES DS1046 SERIES |

| DRAWING TYPE | COSTOMER |
|--------------|-------------------|
| SCALE | 1:1 SHEET 1 OF 1 |
| DRAWING NO. | C-DS1046-09XXXX-C |

晨翔电子有限公司
CONNFLY CONNFLY ELECTRONIC CO. LTD

Tel:86-574-63505787
Fax:86-574-63510817
E-mail:sale@connfly.com
http://www.connfly.com
Add:East Industry Zone, KuangYan Town Cixi Ningbo China
P.C:315333

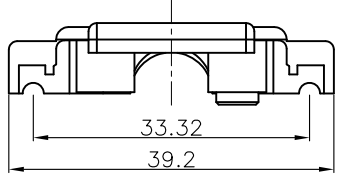

| BOM LIST | | | |
|----------|----------------|------|-------|
| ITEM | PART NAME | Q'ty | NOTES |
| 1 | PLASTIC HOOD | 2 | ABS |
| 2 | 2.1 LONG BOLT | 2 | #4-40 |
| | 2.2 SHORT BOLT | 2 | #4-40 |
| 3 | NUT | 2 | M3 |
| 4 | LONG SCREW | 2 | M3 |
| 5 | SMALL WASHER | 2 | M3 |
| 6 | SHORT SCREW | 2 | M3 |
| 7 | METAL WASHER | 2 | M3 |

| REV. | DESCRIPTION | DRAWN | CHECKED | APPROVED |
|------|----------------|---------------|---------|---------------|
| A | NEW RELEASE | LJH 05/18/05' | ~ | LJC 05/18/05' |
| B | 整理图画 | YCH 09/13/07' | ~ | LJC 09/13/07' |
| C | MINUS P/N CODE | JLZ 12/16/14' | ~ | |

NOTES:
 1. PART NUMBER CODE:
 DS1046 - 15 X X X X
 Washer type (C)
 1: Metal
 Bolt type
 L: Long
 S: Short
 Packing type
 1: Mix packing
 Cover Material
 C: Chromium plating
 Position
 15: 15pin

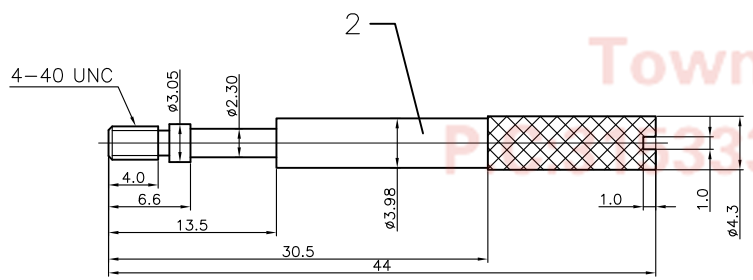
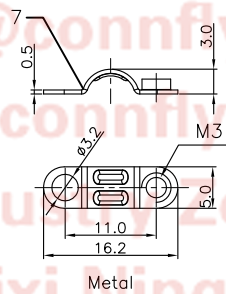
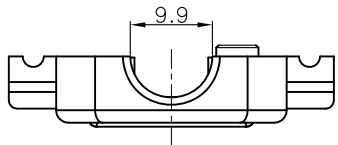
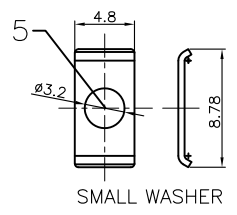
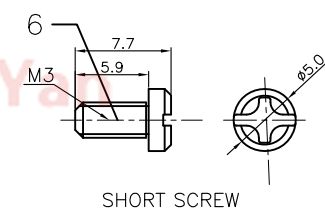
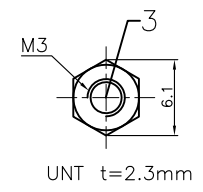
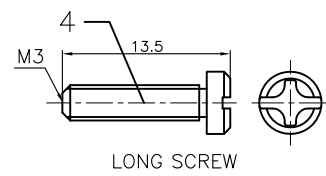
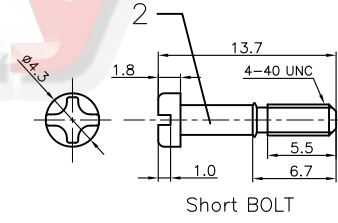
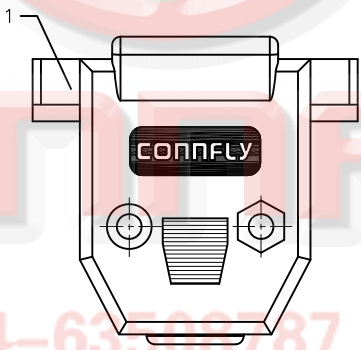
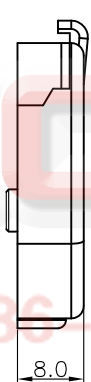
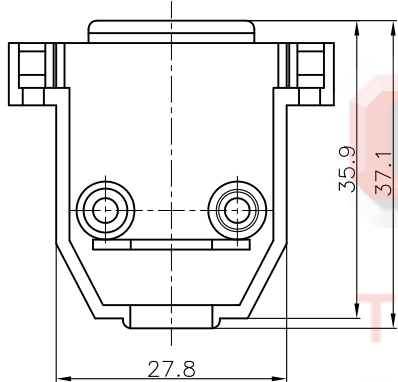
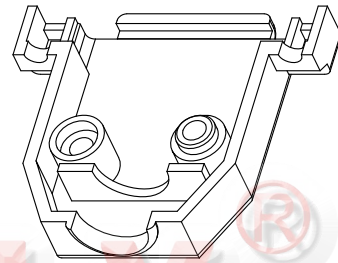

Tel: 86-574-63500787
 Fax: 86-574-63510817
 E-mail: sale@connfly.com
 http://www.connfly.com
 Add: East Industrial Zone Kuang Ya
 Town Cixi Ningbo China

| GENERAL TOLERANCE | ANGLE TOLERANCE |
|-------------------|-----------------|
| X. ±0.60 | X. ±5° |
| .X ±0.38 | .X ±3° |
| .XX ±0.25 | .XX ±2° |

| PROJECTION | TITLE |
|----------------|----------------------------------|
| UNITS: mm | D-SUB 15pin Hood Chromium Plated |
| SHEET SIZE: A4 | SERIES: DS1046 SERIES |

| DRAWING TYPE | CUSTOMER |
|------------------------------|---------------|
| SCALE: 1:1 | SHEET: 1 OF 1 |
| DRAWING NO.: C-DS1046-15XXXX | |

晨翔电子有限公司
CONNFLY CONNFLY ELECTRONIC CO. LTD

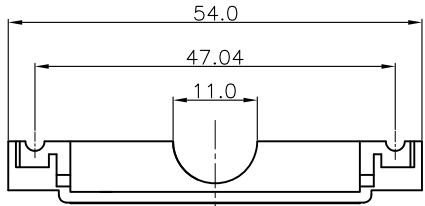

| BOM LIST | | | |
|----------|----------------|------|-------|
| ITEM | PART NAME | Q'ty | NOTES |
| 1 | PLASTIC HOOD | 2 | ABS |
| 2 | 2.1 LONG BOLT | 2 | #4-40 |
| | 2.2 SHORT BOLT | 2 | #4-40 |
| 3 | NUT | 2 | M3 |
| 4 | LONG SCREW | 2 | M3 |
| 5 | SMALL WASHER | 2 | M3 |
| 6 | SHORT SCREW | 2 | M3 |
| 7 | METAL WASHER | 2 | M3 |

| REV. | DESCRIPTION | DRAWN | CHECKED | APPROVED |
|------|----------------|---------------|---------|---------------|
| A | NEW RELEASE | LJH 10/26/05' | ~ | LJC 10/26/05' |
| B | 整理图面 | YCH 09/13/07' | ~ | LJC 09/13/07' |
| C | MINUS P/N CODE | JLZ 12/16/14' | ~ | |

NOTES:

1. PART NUMBER CODE:

DS1046 - 25 X X X X

Washer type (C)
1: Metal

Bolt type

L: Long

S: Short

Packing type

1: Mix packing

Cover Material

C: Chromium plating

Position

25: 25pin

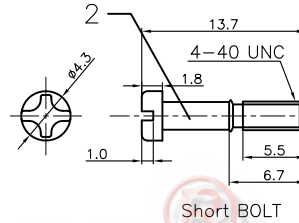

Short BOLT

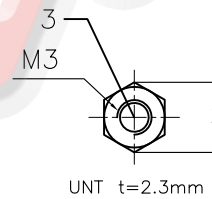

UNT t=2.3mm

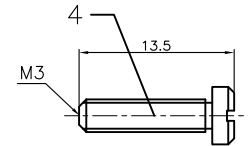

LONG SCREW

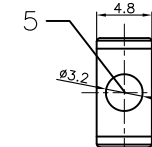

SMALL WASHER

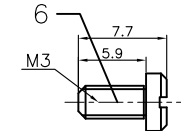

SHORT SCREW

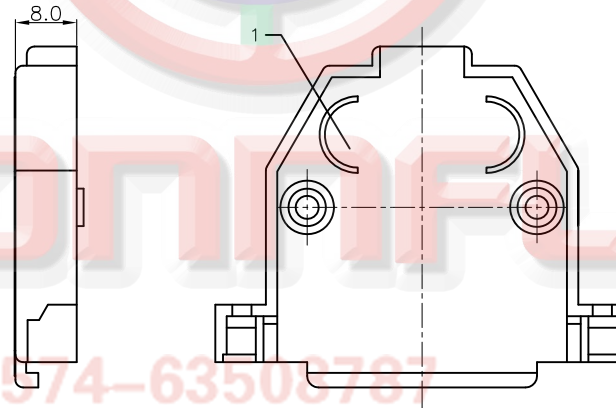
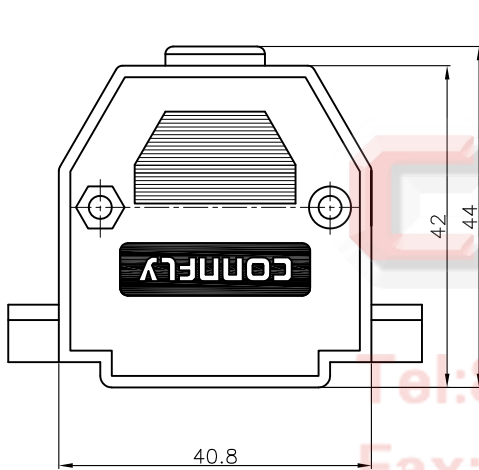

Tel: 86-574-63503787
Fax: 86-574-63510817
E-mail: sale@connfly.com
http://www.connfly.com
Add: East Industry Zone KuangYan
Town Cixi Ningbo China
P.C: 315483

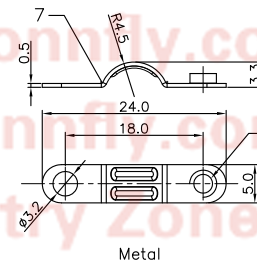

Metal

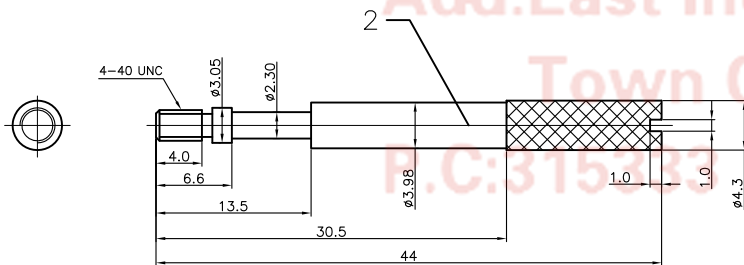

Long BOLT

| GENERAL TOLERANCE | ANGLE TOLERANCE |
|-------------------|-----------------|
| X. ±0.60 | X. ±5° |
| .X ±0.38 | .X ±3° |
| .XX ±0.25 | .XX ±2° |

| PROJECTION | TITLE |
|----------------|----------------------------------|
| UNITS: mm | D-SUB 25pin Hood Chromium plated |
| SHEET SIZE: A4 | SERIES: DS1046 SERIES |

| DRAWING TYPE | CUSTOMER |
|------------------------------|---------------|
| SCALE: 1:1 | SHEET: 1 OF 1 |
| DRAWING NO.: C-DS1046-25XXXX | |

 晨翔电子有限公司
CONNFLY CONNFLY ELECTRONIC CO. LTD

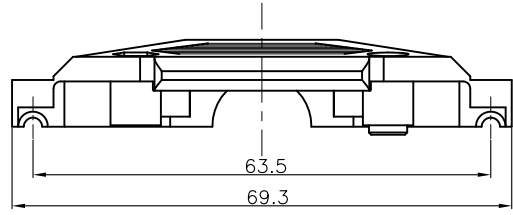

| BOM LIST | | | |
|----------|--------------|------|-------|
| ITEM | PART NAME | Q'ty | NOTES |
| 1 | PLASTIC HOOD | 2 | ABS |
| 2 | LONG BOLT | 2 | #4-40 |
| | SHORT BOLT | 2 | #4-40 |
| 3 | NUT | 2 | M3 |
| 4 | LONG SCREW | 2 | M3 |
| 5 | SMALL WASHER | 2 | |
| 6 | SHORT SCREW | 2 | M3 |
| 7 | METAL WASHER | 2 | M3 |

| REV. | DESCRIPTION | DRAWN | CHECKED | APPROVED |
|------|----------------|---------------|---------|---------------|
| A | NEW RELEASE | LJH 10/26/05' | ~ | LJC 10/26/05' |
| B | 整理图面 | YCH 09/13/07' | ~ | LJC 09/13/07' |
| C | MINUS P/N CODE | JLZ 12/16/14' | ~ | |

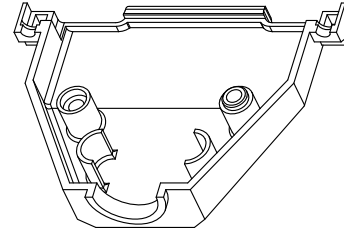

NOTES:
 1. PART NUMBER CODE:
 DS1046 - 37 X X X X
 Washer type (C)
 1: Metal
 Bolt type
 L: Long
 S: Short
 Packing type
 1: Mix packing
 Cover Material
 C: Chromium plating
 Position
 37: 37pin

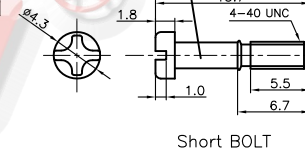
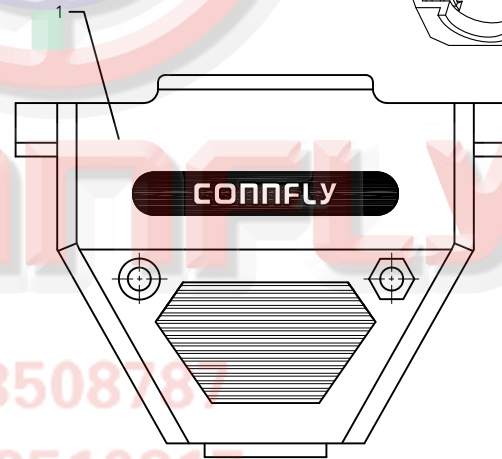
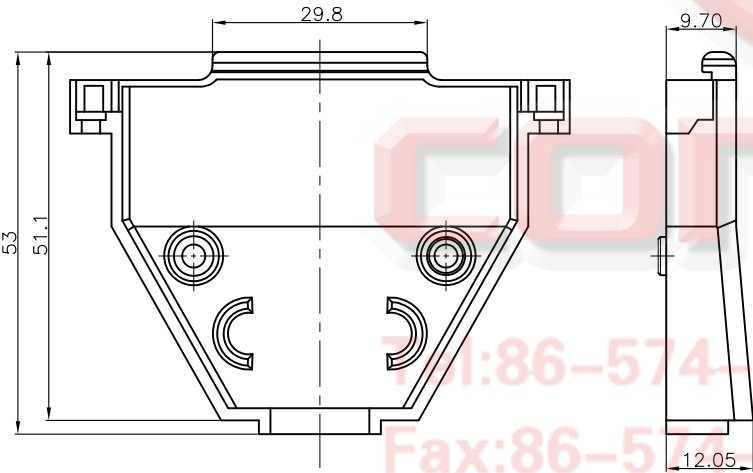

Short BOLT

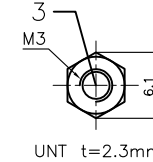

UNT t=2.3mm

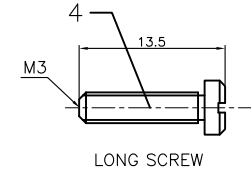

LONG SCREW

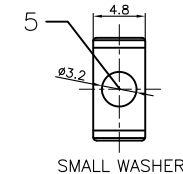

SMALL WASHER

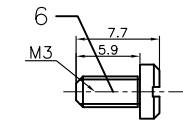

SHORT SCREW

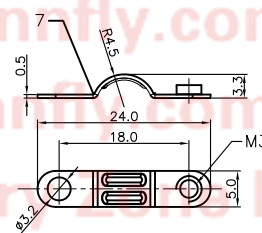
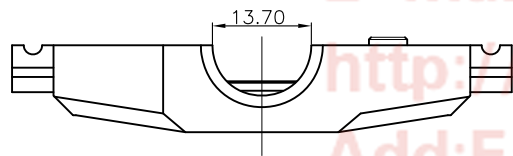

Metal

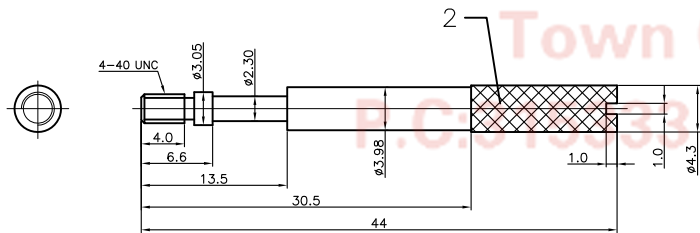

Long BOLT

| GENERAL TOLERANCE | ANGLE TOLERANCE |
|-------------------|-----------------|
| X. ±0.60 | X. ±5° |
| .X ±0.38 | .X ±3° |
| .XX ±0.25 | .XX ±2° |

| PROJECTION | TITLE |
|---------------|----------------------------------|
| UNITS mm | D-SUB 37pin Hood Chromium plated |
| SHEET SIZE A4 | SERIES DS1046 SERIES |

| DRAWING TYPE | CUSTOMER |
|-----------------------------|--------------|
| SCALE 1:1 | SHEET 1 OF 1 |
| DRAWING NO. C-DS1046-37XXXX | |

 晨翔电子有限公司
CONNFLY CONNFLY ELECTRONIC CO. LTD