

BOM LIST			
ITEM	PART NAME	Q'ty	NOTES
1	METAL HOOD	2	
2	LONG BOLT	2	
3	NUT	2	
4	SCREW-1	2	M3*12
5	WASHER	2	
6	SCREW-2	2	M3*6
7	SHORT BOLT	2	

REV.	DESCRIPTION	DRAWN	CHECKED	APPROVED
A	NEW RELEASE	LJC 03/02/07'		

NOTES:

1. PART NUMBER CODE:

DS1047 - 09 X X X

- Bolt type
 - L: Long
 - S: Short
- Packing type
 - 1: Mix packing
 - 2: Separation packing
- Cover Material
 - M: Metal(Zinc alloy)
- Positions
 - 09: 9pin

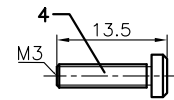
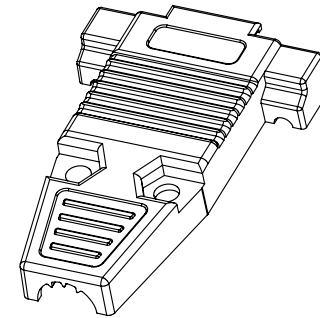
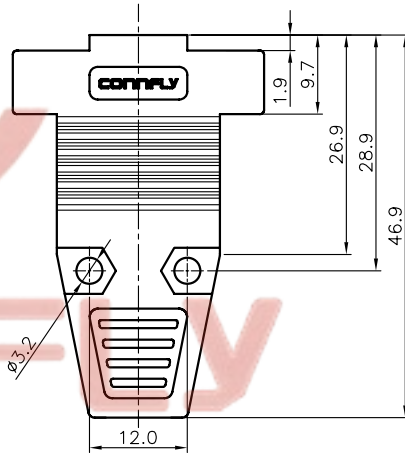
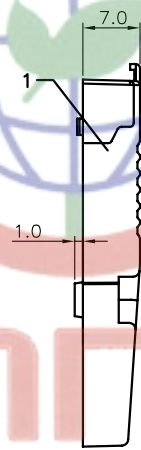
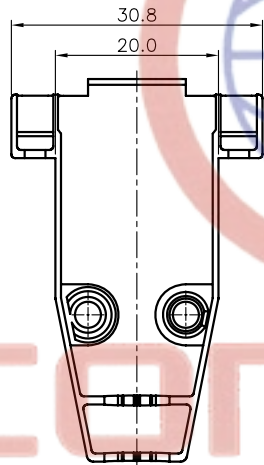

SCREW-1

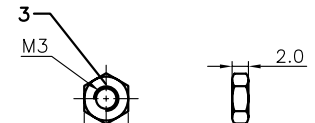
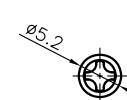

NUT

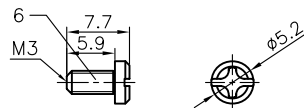

SCREW-2

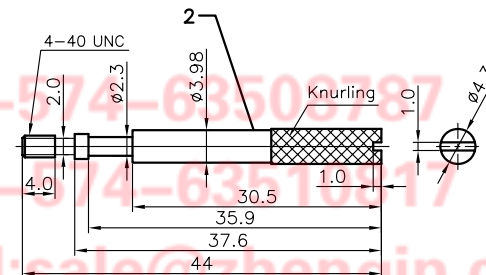
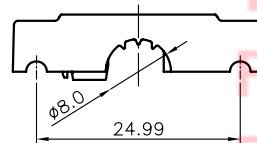

Long BOLT

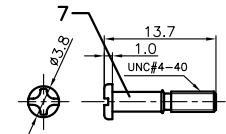

Short BOLT

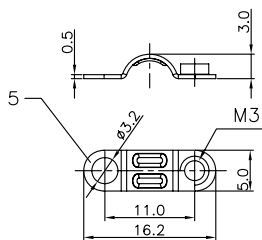

Washer

GENERAL TOLERANCE		ANGLE TOLERANCE		PROJECTION	TITLE	D-SUB 9pin Metal Hood	
X.	±0.60	X.	±5°	UNITS	mm		
.X	±0.38	.X	±3°	SHEET SIZE	A4	SERIES	DS1047 SERIES
.XX	±0.25	.XX	±2°				
DRAWING TYPE		COSTOMER		 晨翔电子有限公司 CONNFLY ELECTRONIC CO., LTD			
SCALE		1:1					
DRAWING NO.		C-DS1047-09XXX					

Tel:86-574-63503787
 Fax:86-574-63510417
 E-mail:sale@zhengqin.com.cn
 Http://www.connfly.com

BOM LIST			
ITEM	PART NAME	Q'ty	NOTES
1	METAL HOOD	2	
2	BOLT	2	
3	NUT	2	
4	SCREW-1	2	M3*12
5	WASHER	2	
6	SCREW-2	2	M3*6
7	SR	1	

REV.	DESCRIPTION	DRAWN	CHECKED	APPROVED
A	NEW RELEASE	LJC 03/02/07'		

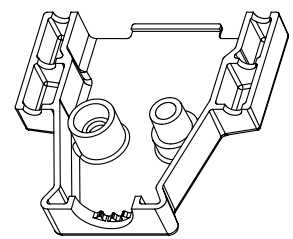
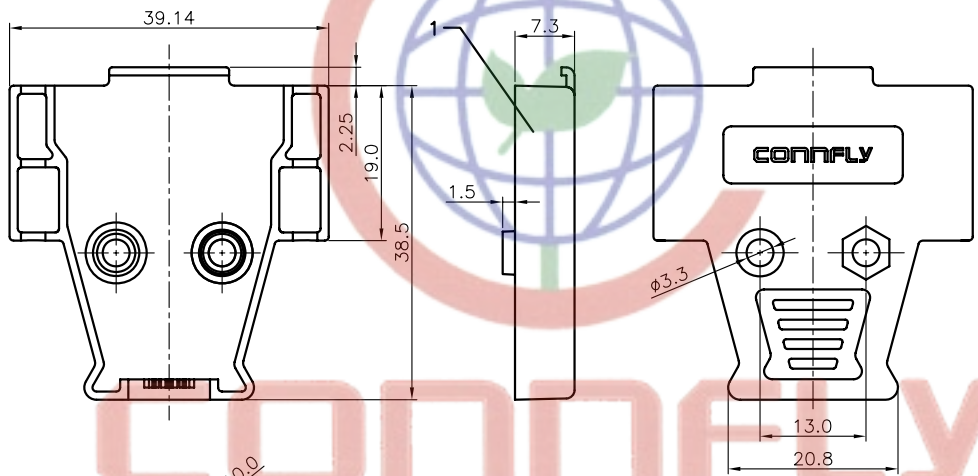

NOTES:
 1. PART NUMBER CODE:
 DS1047 - 15 X X X

- Bolt type
- L: Long
- Packing type
- 1: Mix packing
- 2: Separation packing
- Cover Material
- M: Metal(Zinc alloy)
- Positions
- 15: 15pin

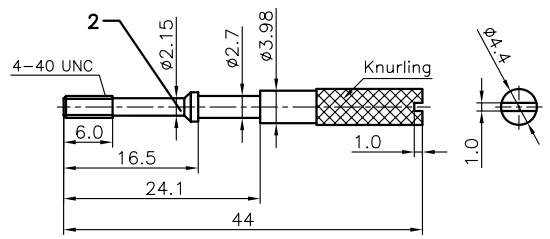

BOLT

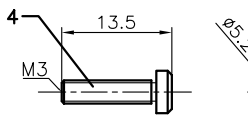
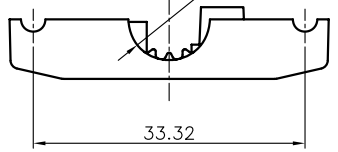

SCREW-1

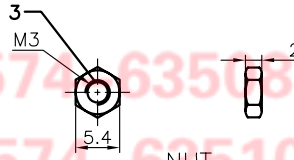

NUT

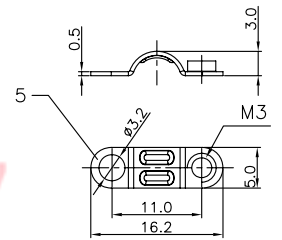

Washer

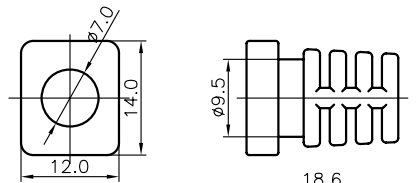

SR

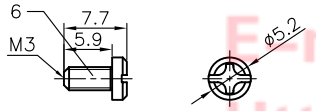

SCREW-2

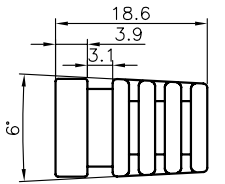

GENERAL TOLERANCE		ANGLE TOLERANCE		PROJECTION		TITLE	
X.	±0.60	X.	±5°			D-SUB 15pin Metal Hood	
.X	±0.38	.X	±3°	mm		SERIES DS1047 SERIES	
.XX	±0.25	.XX	±2°	A4		CONNFLY CONNFLY ELECTRONIC CO., LTD	
DRAWING TYPE		CUSTOMER		SCALE		DRAWING NO.	
1:1		1 OF 1		C-DS1047-15XXX			

Tel:86-574-63505787
 Fax:86-574-63510817
 E-mail:sale@zhenqin.com.cn
 Http://www.connfly.com

晨翔电子有限公司
 CONNFLY CONNFLY ELECTRONIC CO., LTD

BOM LIST			
ITEM	PART NAME	Q'ty	NOTES
1	METAL HOOD	2	
2	BOLT	2	
3	NUT	2	
4	SCREW-1	2	M3*12
5	WASHER	2	
6	SCREW-2	2	M3*6
7	SR	1	

REV.	DESCRIPTION	DRAWN	CHECKED	APPROVED
A	NEW RELEASE	LJC 03/02/07'		

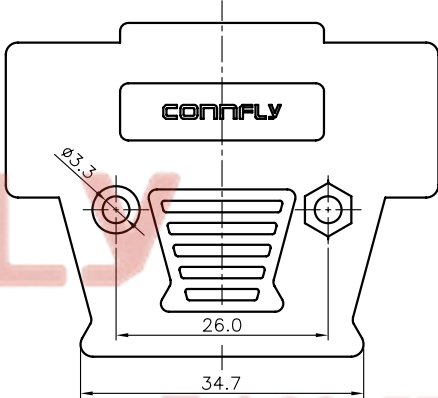
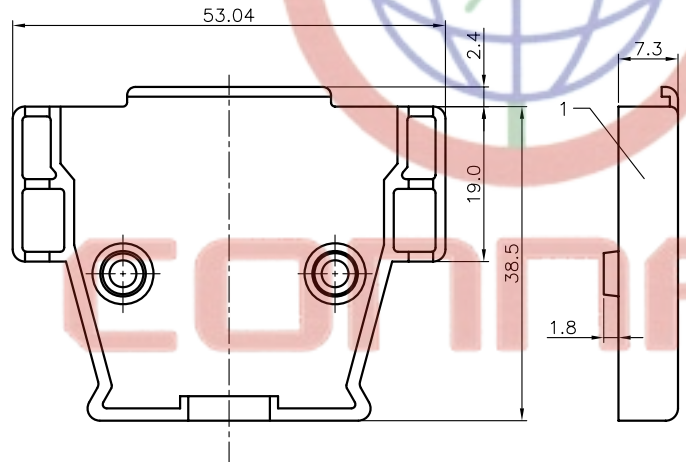
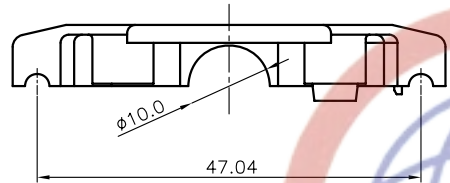

NOTES:
1. PART NUMBER CODE:

DS1047 - 25 X X X

- Long type
L: Long
- Packing type
1: Mix packing
2: Separation packing
- Cover Material
M: Metal(Znic alloy)
- Positions
25: 25pin

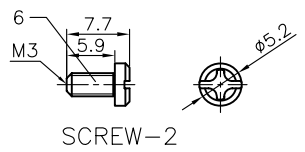
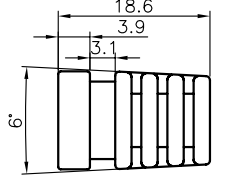
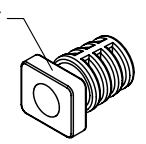
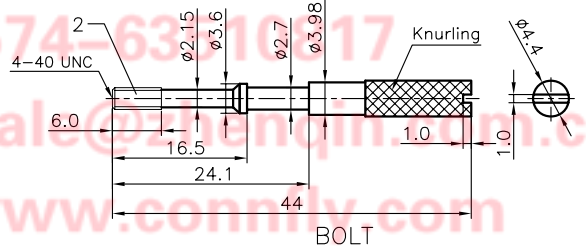
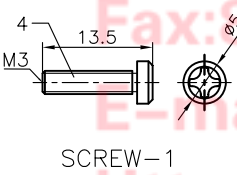
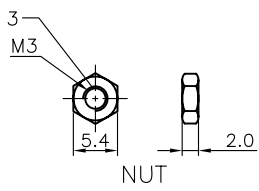
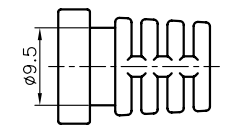
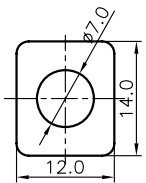
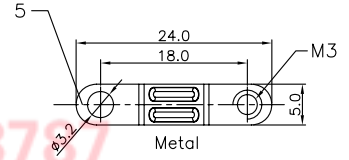
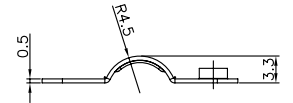
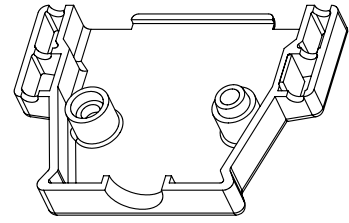

GENERAL TOLERANCE	ANGLE TOLERANCE
X. ±0.60	X. ±5°
.X ±0.38	.X ±3°
.XX ±0.25	.XX ±2°

PROJECTION	TITLE
	D-SUB 25pin Metal Hood

UNITS	SHEET SIZE
mm	A4

SERIES	DS1047 SERIES

DRAWING TYPE	CUSTOMER
SCALE	1:1 SHEET 1 OF 1
DRAWING NO.	C-DS1047-25XXX

晨翔电子有限公司
CONNFLY CONNFLY ELECTRONIC CO., LTD

Tel:86-574-63508787
Fax:86-574-63110817
E-mail:sale@connfly.com.cn
Http://www.connfly.com

BOM LIST			
ITEM	PART NAME	Q'ty	NOTES
1	METAL HOOD	2	
2	BOLT	2	
3	NUT	2	
4	SCREW-1	2	M3*12
5	WASHER	2	
6	SCREW-2	2	M3*6
7	SR	1	

REV.	DESCRIPTION	DRAWN	CHECKED	APPROVED
A	NEW RELEASE	LJC 03/02/07'		

NOTES:
 1. PART NUMBER CODE:
 DS1047 - 37 X X X
 Bolt type
 L: Long
 Packing type
 1: Mix packing
 2: Separation packing
 Cover Material
 M: Metal(Zinc alloy)
 Positions
 37: 37pin

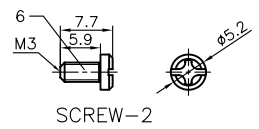
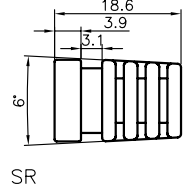
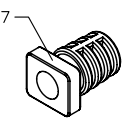
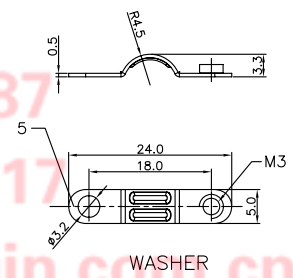
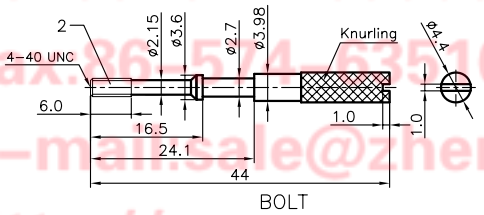
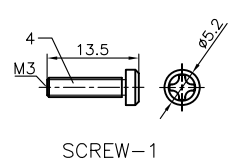
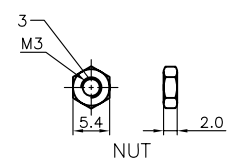
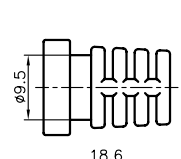
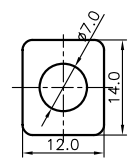
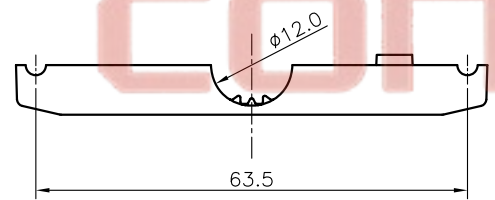
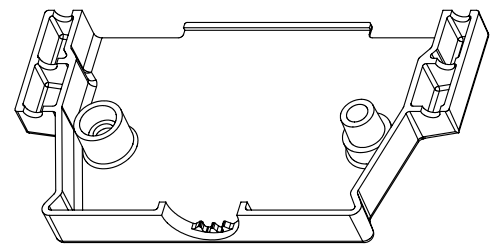
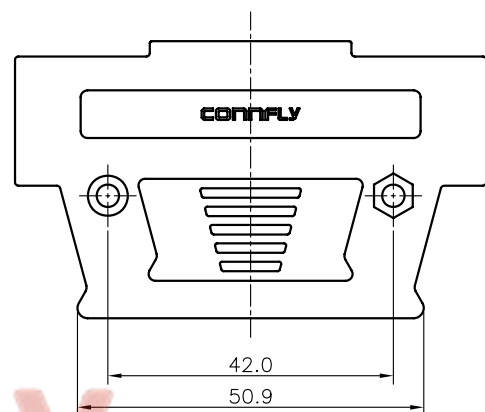
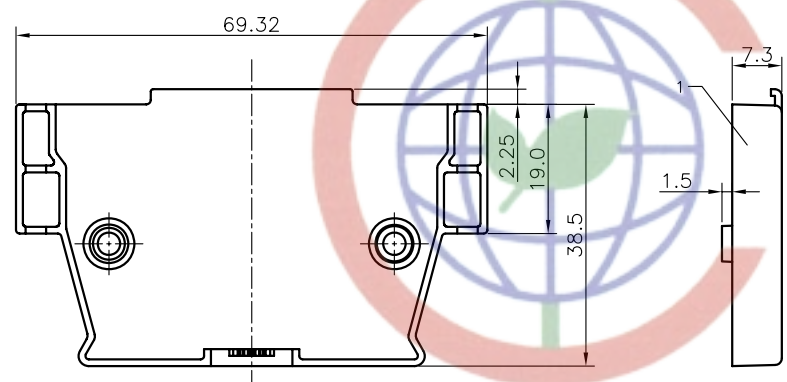

GENERAL TOLERANCE	ANGLE TOLERANCE	PROJECTION		TITLE	D-SUB 37pin Metal Hood
X. ± 0.60	X. $\pm 5^\circ$	UNITS	mm	SHEET	DS1047 SERIES
.X ± 0.38	.X $\pm 3^\circ$	SHEET SIZE	A4		
.XX ± 0.25	.XX $\pm 2^\circ$				
DRAWING TYPE	CUSTOMER				
SCALE	1:1	SHEET	1 OF 1		
DRAWING NO.	C-DS1047-37XXX		晨翔电子有限公司 CONNFLY CONNFLY ELECTRONIC CO., LTD		

Tel:86-574-63508787
 Fax:86-574-63510817
 E-mail:sale@zhenqin.com.cn
 Http://www.connfly.com
 Add:East Industry Zone Kuang Yan
 Town Xi Ning China
 P.O. 515355