

IRL3705NPbF

- Lead-Free
- Logic-Level Gate Drive
- Advanced Process Technology
- Dynamic dv/dt Rating
- 175°C Operating Temperature
- Fast Switching
- Fully Avalanche Rated

Description

Fifth Generation HEXFETs from International Rectifier utilize advanced processing techniques to achieve extremely low on-resistance per silicon area. This benefit, combined with the fast switching speed and ruggedized device design that HEXFET Power MOSFETs are well known for, provides the designer with an extremely efficient and reliable device for use in a wide variety of applications.

The TO-220 package is universally preferred for all commercial-industrial applications at power dissipation levels to approximately 50 watts. The low thermal resistance and low package cost of the TO-220 contribute to its wide acceptance throughout the industry.

HEXFET® Power MOSFET

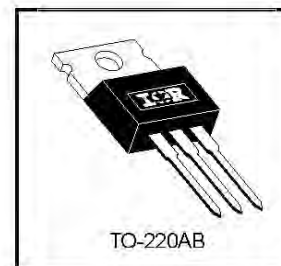
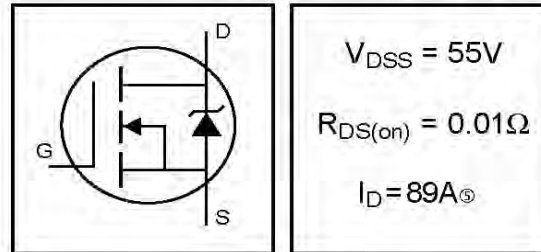

Absolute Maximum Ratings

| | Parameter | Max. | Units |
|---------------------------|--|------------------------|-------|
| $I_D @ T_C = 25^\circ C$ | Continuous Drain Current, $V_{GS} @ 10V$ | 89 ⁽⁵⁾ | A |
| $I_D @ T_C = 100^\circ C$ | Continuous Drain Current, $V_{GS} @ 10V$ | 63 | |
| I_{DM} | Pulsed Drain Current ⁽¹⁾ | 310 | |
| $P_D @ T_C = 25^\circ C$ | Power Dissipation | 170 | W |
| | Linear Derating Factor | 1.1 | W/°C |
| V_{GS} | Gate-to-Source Voltage | ± 16 | V |
| E_{AS} | Single Pulse Avalanche Energy ⁽²⁾ | 340 | mJ |
| I_{AR} | Avalanche Current ⁽¹⁾ | 46 | A |
| E_{AR} | Repetitive Avalanche Energy ⁽¹⁾ | 17 | mJ |
| dv/dt | Peak Diode Recovery dv/dt ⁽³⁾ | 5.0 | V/ns |
| T_J | Operating Junction and | -55 to + 175 | °C |
| T_{STG} | Storage Temperature Range | | |
| | Soldering Temperature, for 10 seconds | 300 (1.6mm from case) | |
| | Mounting torque, 6-32 or M3 screw | 10 lbf·in (1.1N·m) | |

Thermal Resistance

| | Parameter | Typ. | Max. | Units |
|-----------------|-------------------------------------|------|------|-------|
| $R_{\theta JC}$ | Junction-to-Case | — | 0.90 | °C/W |
| $R_{\theta CS}$ | Case-to-Sink, Flat, Greased Surface | 0.50 | — | |
| $R_{\theta JA}$ | Junction-to-Ambient | — | 62 | |

Electrical Characteristics @ $T_J = 25^\circ\text{C}$ (unless otherwise specified)

| | Parameter | Min. | Typ. | Max. | Units | Conditions |
|---------------------------------|--------------------------------------|------|-------|-------|----------|---|
| $V_{(BR)DSS}$ | Drain-to-Source Breakdown Voltage | 55 | — | — | V | $V_{GS} = 0V, I_D = 250\mu A$ |
| $\Delta V_{(BR)DSS}/\Delta T_J$ | Breakdown Voltage Temp. Coefficient | — | 0.056 | — | V/°C | Reference to 25°C , $I_D = 1mA$ |
| $R_{DS(on)}$ | Static Drain-to-Source On-Resistance | — | — | 0.010 | Ω | $V_{GS} = 10V, I_D = 46A$ ④ |
| | | — | — | 0.012 | | $V_{GS} = 5.0V, I_D = 46A$ ④ |
| | | — | — | 0.018 | | $V_{GS} = 4.0V, I_D = 39A$ ④ |
| $V_{GS(th)}$ | Gate Threshold Voltage | 1.0 | — | 2.0 | V | $V_{DS} = V_{GS}, I_D = 250\mu A$ |
| g_{fs} | Forward Transconductance | 50 | — | — | S | $V_{DS} = 25V, I_D = 46A$ |
| I_{DSS} | Drain-to-Source Leakage Current | — | — | 25 | μA | $V_{DS} = 55V, V_{GS} = 0V$ |
| | | — | — | 250 | | $V_{DS} = 44V, V_{GS} = 0V, T_J = 150^\circ\text{C}$ |
| I_{GSS} | Gate-to-Source Forward Leakage | — | — | 100 | nA | $V_{GS} = 16V$ |
| | Gate-to-Source Reverse Leakage | — | — | -100 | | $V_{GS} = -16V$ |
| Q_g | Total Gate Charge | — | — | 98 | nC | $I_D = 46A$ |
| Q_{gs} | Gate-to-Source Charge | — | — | 19 | | $V_{DS} = 44V$ |
| Q_{gd} | Gate-to-Drain ("Miller") Charge | — | — | 49 | | $V_{GS} = 5.0V$, See Fig. 6 and 13 ④ |
| $t_{d(on)}$ | Turn-On Delay Time | — | 12 | — | ns | $V_{DD} = 28V$ |
| t_r | Rise Time | — | 140 | — | | $I_D = 46A$ |
| $t_{d(off)}$ | Turn-Off Delay Time | — | 37 | — | | $R_G = 1.8\Omega, V_{GS} = 5.0V$ |
| t_f | Fall Time | — | 78 | — | | $R_D = 0.59\Omega$, See Fig. 10 ④ |
| L_D | Internal Drain Inductance | — | 4.5 | — | nH | Between lead, 6mm (0.25in.) from package and center of die contact |
| L_S | Internal Source Inductance | — | 7.5 | — | |  |
| C_{iss} | Input Capacitance | — | 3600 | — | pF | $V_{GS} = 0V$ |
| C_{oss} | Output Capacitance | — | 870 | — | | $V_{DS} = 25V$ |
| C_{rss} | Reverse Transfer Capacitance | — | 320 | — | | $f = 1.0MHz$, See Fig. 5 |

Source-Drain Ratings and Characteristics

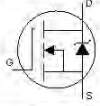
| | Parameter | Min. | Typ. | Max. | Units | Conditions |
|----------|--|---|------|------|-------|--|
| I_S | Continuous Source Current (Body Diode) | — | — | 89⑤ | A | MOSFET symbol showing the integral reverse p-n junction diode.  |
| I_{SM} | Pulsed Source Current (Body Diode) ① | — | — | 310 | | |
| V_{SD} | Diode Forward Voltage | — | — | 1.3 | V | $T_J = 25^\circ\text{C}, I_S = 46A, V_{GS} = 0V$ ④ |
| t_{rr} | Reverse Recovery Time | — | 94 | 140 | ns | $T_J = 25^\circ\text{C}, I_F = 46A$ |
| Q_{rr} | Reverse Recovery Charge | — | 290 | 440 | nC | $di/dt = 100A/\mu s$ ④ |
| t_{on} | Forward Turn-On Time | Intrinsic turn-on time is negligible (turn-on is dominated by $L_S + L_D$) | | | | |

Notes:

- ① Repetitive rating; pulse width limited by max. junction temperature. (See fig. 11)
- ② $V_{DD} = 25V$, starting $T_J = 25^\circ\text{C}$, $L = 320\mu H$, $R_G = 25\Omega$, $I_{AS} = 46A$. (See Figure 12)

- ③ $I_{SD} \leq 46A$, $di/dt \leq 250A/\mu s$, $V_{DD} \leq V_{(BR)DSS}$, $T_J \leq 175^\circ\text{C}$

- ④ Pulse width $\leq 300\mu s$; duty cycle $\leq 2\%$.

- ⑤ Calculated continuous current based on maximum allowable junction temperature; for recommended current-handling of the package refer to Design Tip # 93-4

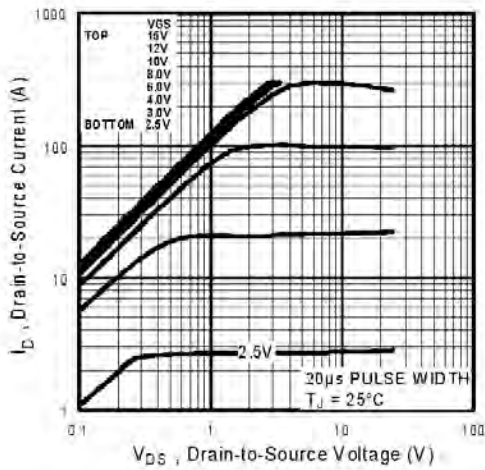

Fig 1. Typical Output Characteristics

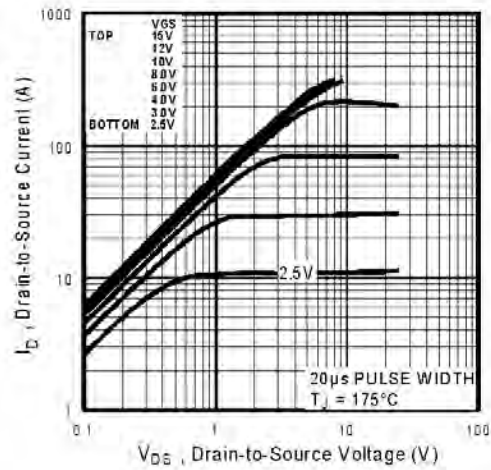

Fig 2. Typical Output Characteristics

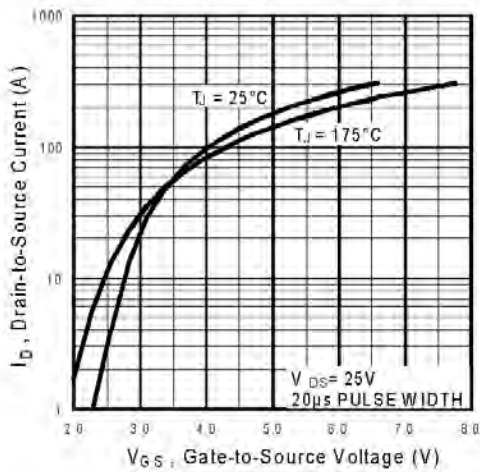

Fig 3. Typical Transfer Characteristics

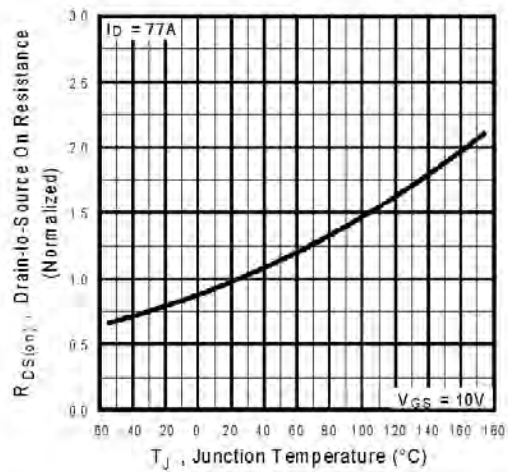

Fig 4. Normalized On-Resistance Vs. Temperature

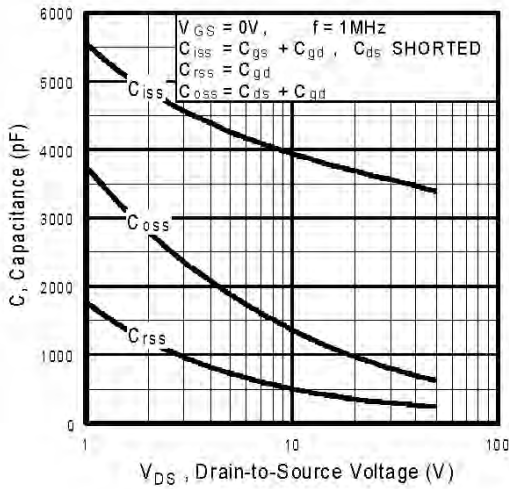

Fig 5. Typical Capacitance Vs. Drain-to-Source Voltage

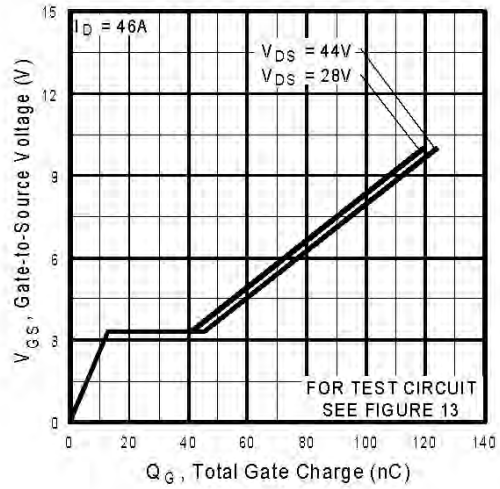

Fig 6. Typical Gate Charge Vs. Gate-to-Source Voltage

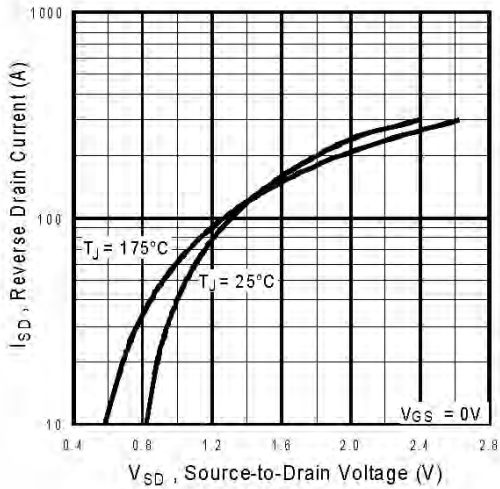

Fig 7. Typical Source-Drain Diode Forward Voltage

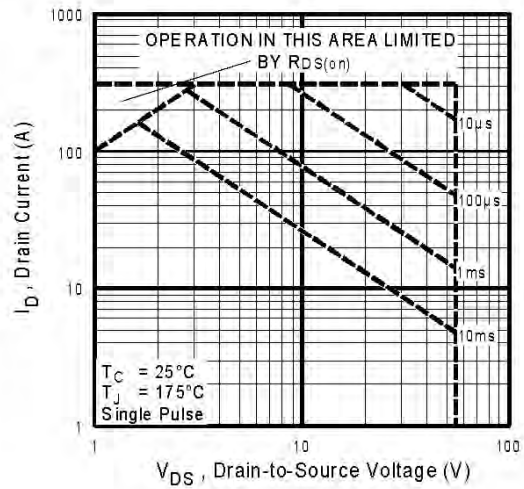

Fig 8. Maximum Safe Operating Area

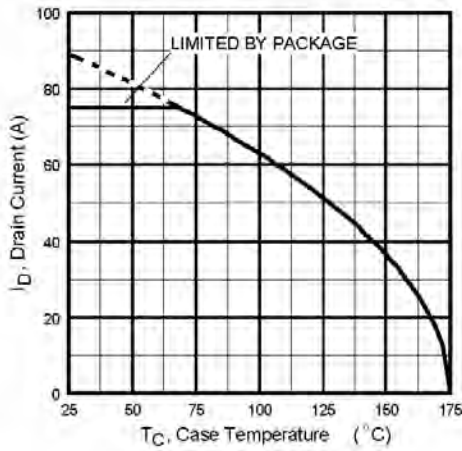

Fig 9. Maximum Drain Current Vs. Case Temperature

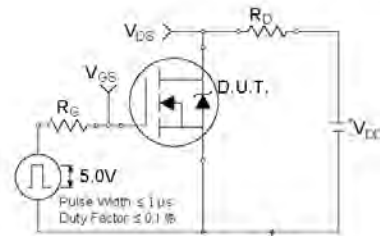

Fig 10a. Switching Time Test Circuit

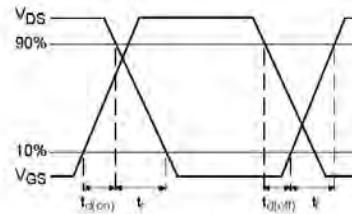

Fig 10b. Switching Time Waveforms

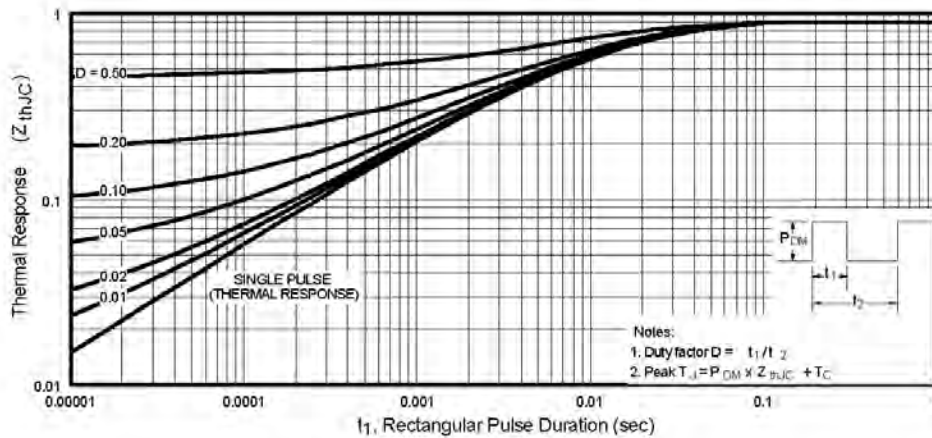

Fig 11. Maximum Effective Transient Thermal Impedance, Junction-to-Case

IRL3705NPbF

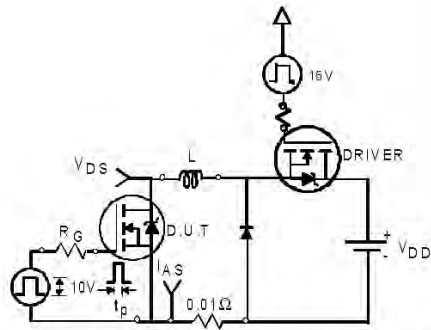

Fig 12a. Unclamped Inductive Test Circuit

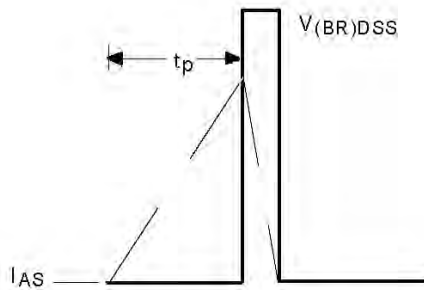

Fig 12b. Unclamped Inductive Waveforms

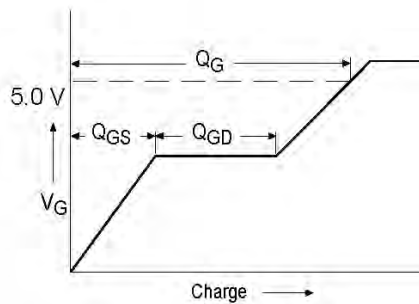

Fig 13a. Basic Gate Charge Waveform

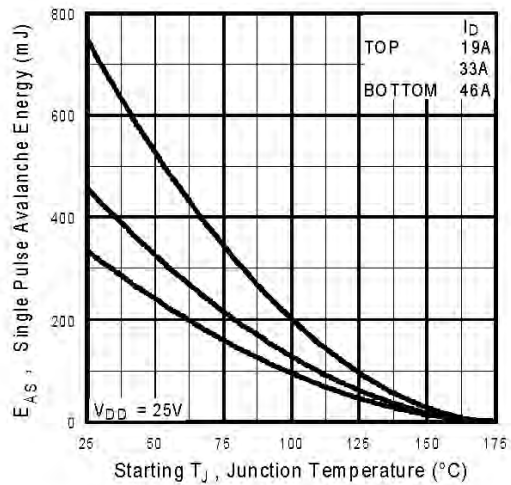

Fig 12c. Maximum Avalanche Energy Vs. Drain Current

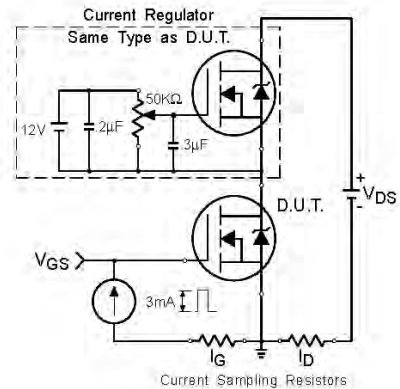
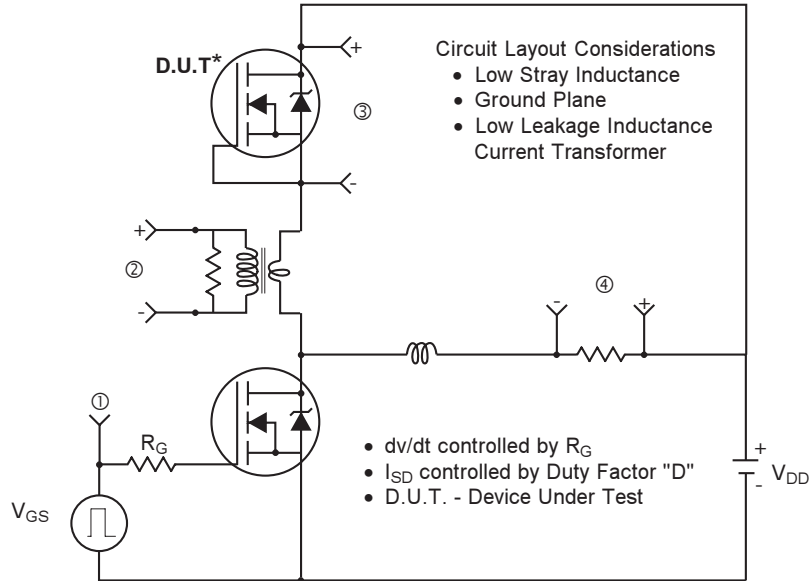
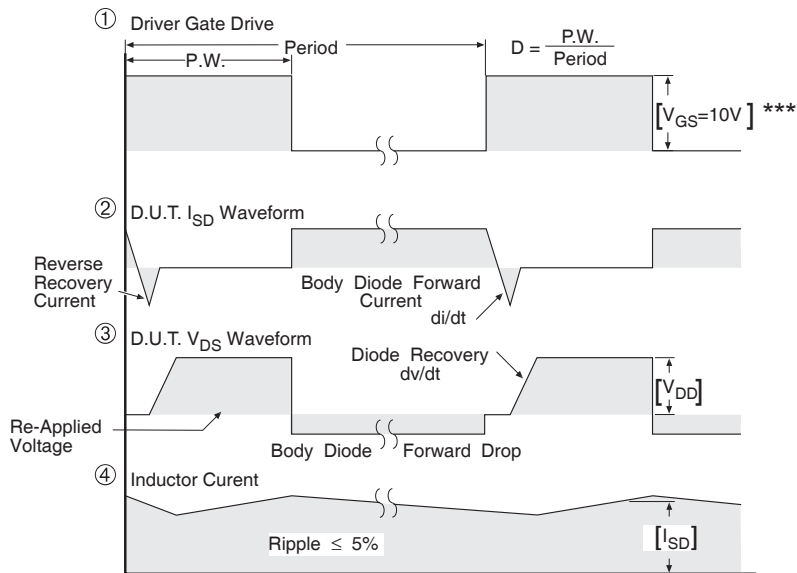

Fig 13b. Gate Charge Test Circuit

Peak Diode Recovery dv/dt Test Circuit



* Reverse Polarity of D.U.T. for P-Channel



*** $V_{GS} = 5.0V$ for Logic Level and 3V Drive Devices

IRL3705NPbF



TO-220AB Package Outline

Dimensions are shown in millimeters (inches)

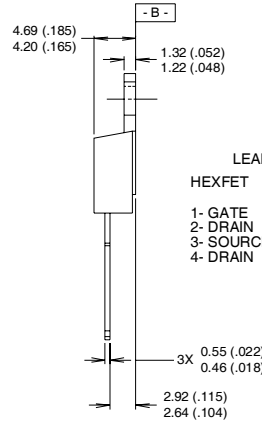
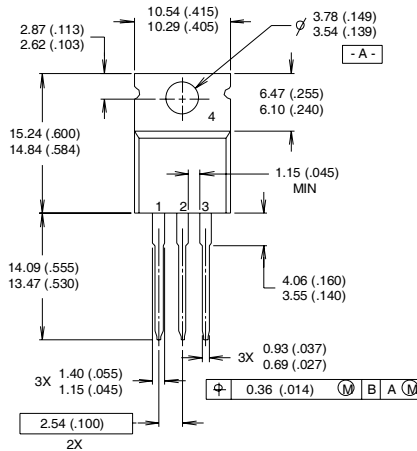

| LEAD ASSIGNMENTS | |
|------------------|---------------|
| HEXFET | IGBTs, CoPACK |
| 1- GATE | 1- GATE |
| 2- DRAIN | 2- COLLECTOR |
| 3- SOURCE | 3- EMITTER |
| 4- DRAIN | 4- COLLECTOR |

- NOTES:
- 1 DIMENSIONING & TOLERANCING PER ANSI Y14.5M, 1982.
 - 2 CONTROLLING DIMENSION : INCH
 - 3 OUTLINE CONFORMS TO JEDEC OUTLINE TO-220AB.
 - 4 HEATSINK & LEAD MEASUREMENTS DO NOT INCLUDE BURRS.

TO-220AB Part Marking Information

EXAMPLE: THIS IS AN IRF1010
 LOT CODE 1789
 ASSEMBLED ON WW 19, 1997
 IN THE ASSEMBLY LINE "C"
Note: "P" in assembly line
 position indicates "Lead-Free"

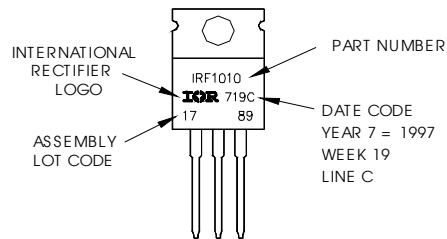

Data and specifications subject to change without notice.



IR WORLD HEADQUARTERS: 233 Kansas St., El Segundo, California 90245, USA Tel: (310) 252-7105
 TAC Fax: (310) 252-7903

Visit us at www.irf.com for sales contact information.01/04
www.irf.com

Note: For the most current drawings please refer to the IR website at:
<http://www.irf.com/package/>