

# NPN - MJ15022, MJ15024\*

\*MJ15024 is a Preferred Device

## Silicon Power Transistors

The MJ15022 and MJ15024 are PowerBase power transistors designed for high power audio, disk head positioners and other linear applications.

### Features

- High Safe Operating Area (100% Tested) – 2 A @ 80 V
- High DC Current Gain –  $h_{FE} = 15$  (Min) @  $I_C = 8$  Adc
- Pb-Free Packages are Available\*

### MAXIMUM RATINGS

Rating	Symbol	Value	Unit
Collector-Emitter Voltage MJ15022 MJ15024	$V_{CEO}$	200 250	Vdc
Collector-Base Voltage MJ15022 MJ15024	$V_{CBO}$	350 400	Vdc
Emitter-Base Voltage	$V_{EBO}$	5	Vdc
Collector-Emitter Voltage	$V_{CEX}$	400	Vdc
Collector Current – Continuous – Peak (Note 1)	$I_C$	16 30	Adc
Base Current – Continuous	$I_B$	5	Adc
Total Device Dissipation @ $T_C = 25^\circ\text{C}$ Derate above $25^\circ\text{C}$	$P_D$	250 1.43	W W/ $^\circ\text{C}$
Operating and Storage Junction Temperature Range	$T_J, T_{stg}$	-65 to +200	$^\circ\text{C}$

### THERMAL CHARACTERISTICS

Characteristics	Symbol	Max	Unit
Thermal Resistance, Junction-to-Case	$R_{\theta JC}$	0.70	$^\circ\text{C}/\text{W}$

Maximum ratings are those values beyond which device damage can occur. Maximum ratings applied to the device are individual stress limit values (not normal operating conditions) and are not valid simultaneously. If these limits are exceeded, device functional operation is not implied, damage may occur and reliability may be affected.

1. Pulse Test: Pulse Width = 5 ms, Duty Cycle  $\leq 10\%$ .



**ON Semiconductor®**

<http://onsemi.com>

**16 AMPERES  
SILICON POWER TRANSISTORS  
200 – 250 VOLTS, 250 WATTS**

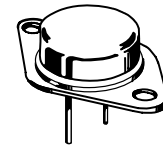

**TO-204AA (TO-3)  
CASE 1-07  
STYLE 1**

### MARKING DIAGRAM



MJ1502x = Device Code  
x = 2 or 4  
G = Pb-Free Package  
A = Assembly Location  
Y = Year  
WW = Work Week  
MEX = Country of Origin

### ORDERING INFORMATION

Device	Package	Shipping
MJ15022	TO-204	100 Units / Tray
MJ15022G	TO-204 (Pb-Free)	100 Units / Tray
MJ15024	TO-204	100 Units / Tray
MJ15024G	TO-204 (Pb-Free)	100 Units / Tray

**Preferred** devices are recommended choices for future use and best overall value.

\*For additional information on our Pb-Free strategy and soldering details, please download the ON Semiconductor Soldering and Mounting Techniques Reference Manual, SOLDERRM/D.

# NPN – MJ15022, MJ15024\*

## ELECTRICAL CHARACTERISTICS (T<sub>C</sub> = 25°C unless otherwise noted)

Characteristic	Symbol	Min	Max	Unit
<b>OFF CHARACTERISTICS</b>				
Collector–Emitter Sustaining Voltage (Note 2) (I <sub>C</sub> = 100 mA <sub>dc</sub> , I <sub>B</sub> = 0)	MJ15022 MJ15024	V <sub>CEO(sus)</sub>	200 250	–
Collector Cutoff Current (V <sub>CE</sub> = 200 V <sub>dc</sub> , V <sub>BE(off)</sub> = 1.5 V <sub>dc</sub> ) (V <sub>CE</sub> = 250 V <sub>dc</sub> , V <sub>BE(off)</sub> = 1.5 V <sub>dc</sub> )	MJ15022 MJ15024	I <sub>CEX</sub>	– –	250 250
Collector Cutoff Current (V <sub>CE</sub> = 150 V <sub>dc</sub> , I <sub>B</sub> = 0) (V <sub>CE</sub> = 200 V <sub>dc</sub> , I <sub>B</sub> = 0)	MJ15022 MJ15024	I <sub>CEO</sub>	– –	500 500
Emitter Cutoff Current (V <sub>CE</sub> = 5 V <sub>dc</sub> , I <sub>B</sub> = 0)		I <sub>EBO</sub>	–	500
<b>SECOND BREAKDOWN</b>				
Second Breakdown Collector Current with Base Forward Biased (V <sub>CE</sub> = 50 V <sub>dc</sub> , t = 0.5 s (non–repetitive)) (V <sub>CE</sub> = 80 V <sub>dc</sub> , t = 0.5 s (non–repetitive))		I <sub>S/b</sub>	5 2	– –
<b>ON CHARACTERISTICS</b>				
DC Current Gain (I <sub>C</sub> = 8 A <sub>dc</sub> , V <sub>CE</sub> = 4 V <sub>dc</sub> ) (I <sub>C</sub> = 16 A <sub>dc</sub> , V <sub>CE</sub> = 4 V <sub>dc</sub> )		h <sub>FE</sub>	15 5	60 –
Collector–Emitter Saturation Voltage (I <sub>C</sub> = 8 A <sub>dc</sub> , I <sub>B</sub> = 0.8 A <sub>dc</sub> ) (I <sub>C</sub> = 16 A <sub>dc</sub> , I <sub>B</sub> = 3.2 A <sub>dc</sub> )		V <sub>CE(sat)</sub>	– –	1.4 4.0
Base–Emitter On Voltage (I <sub>C</sub> = 8 A <sub>dc</sub> , V <sub>CE</sub> = 4 V <sub>dc</sub> )		V <sub>BE(on)</sub>	–	2.2
<b>DYNAMIC CHARACTERISTICS</b>				
Current–Gain – Bandwidth Product (I <sub>C</sub> = 1 A <sub>dc</sub> , V <sub>CE</sub> = 10 V <sub>dc</sub> , f <sub>test</sub> = 1 MHz)		f <sub>T</sub>	4	–
Output Capacitance (V <sub>CB</sub> = 10 V <sub>dc</sub> , I <sub>E</sub> = 0, f <sub>test</sub> = 1 MHz)		C <sub>ob</sub>	–	500

2. Pulse Test: Pulse Width = 300 μs, Duty Cycle ≤ 2%.

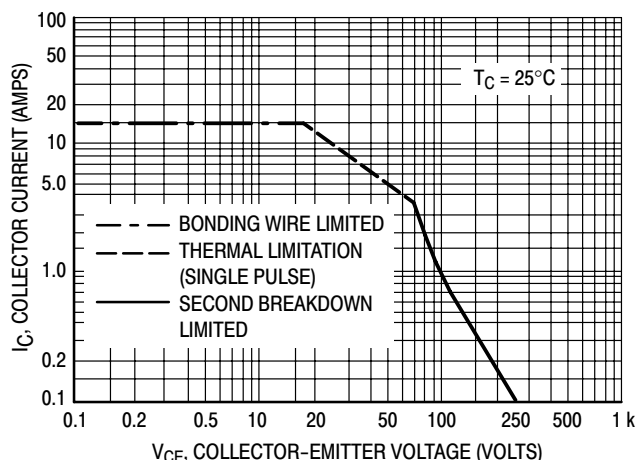

**Figure 1. Active–Region Safe Operating Area**

There are two limitations on the powerhandling ability of a transistor: average junction temperature and second breakdown. Safe operating area curves indicate I<sub>C</sub> – V<sub>CE</sub> limits of the transistor that must be observed for reliable operation; i.e., the transistor must not be subjected to greater dissipation than the curves indicate.

The data of Figure 1 is based on T<sub>J(pk)</sub> = 200°C; T<sub>C</sub> is variable depending on conditions. At high case temperatures, thermal limitations will reduce the power that can be handled to values I<sub>on</sub> than the limitations imposed by second breakdown.

# NPN – MJ15022, MJ15024\*

## TYPICAL CHARACTERISTICS

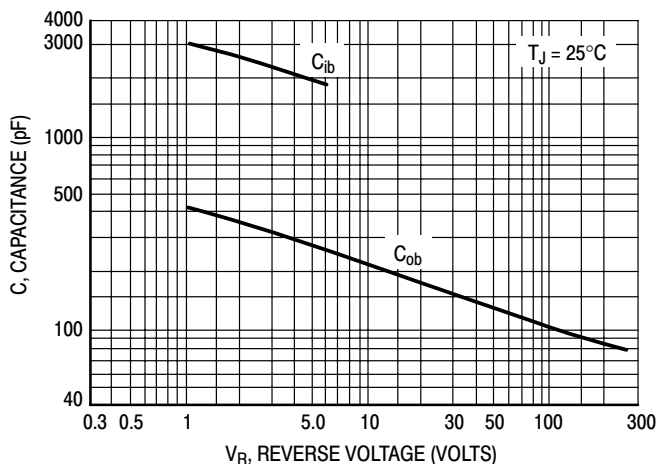

Figure 2. Capacitances

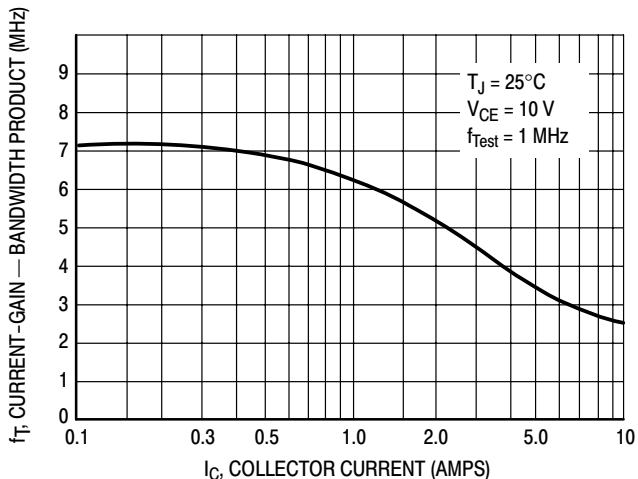

Figure 3. Current-Gain — Bandwidth Product

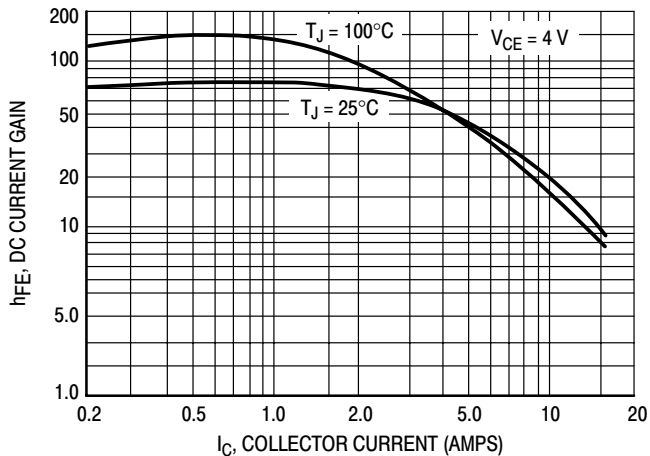

Figure 4. DC Current Gain

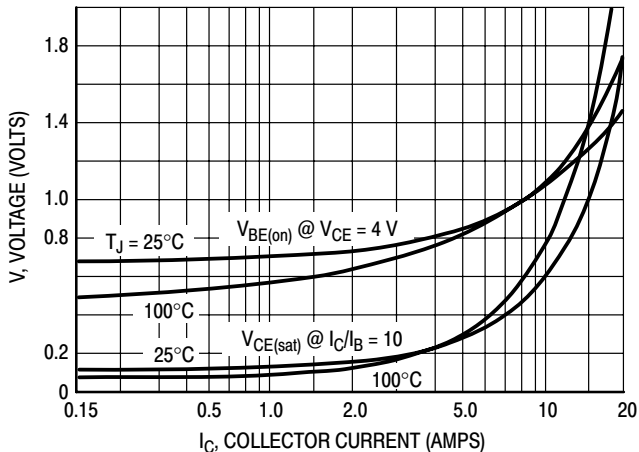

Figure 5. "On" Voltage

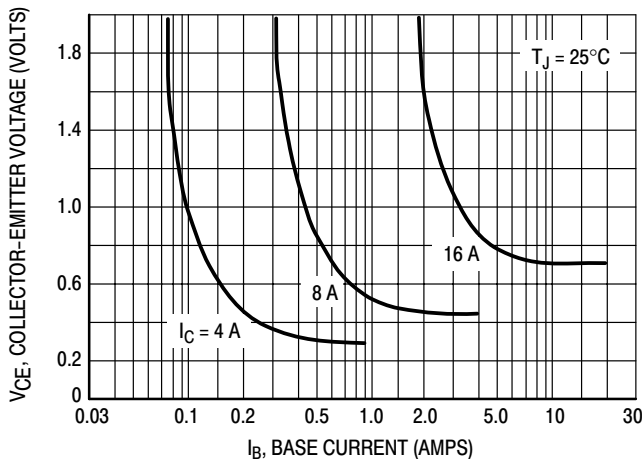
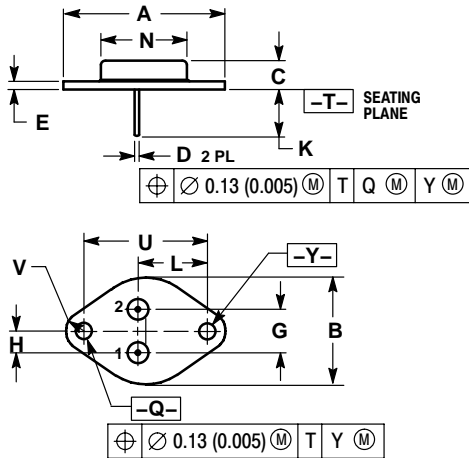

Figure 6. Collector Saturation Region

# NPN – MJ15022, MJ15024\*

## PACKAGE DIMENSIONS

### TO-204 (TO-3) CASE 1-07 ISSUE Z



#### NOTES:

1. DIMENSIONING AND TOLERANCING PER ANSI Y14.5M, 1982.
2. CONTROLLING DIMENSION: INCH.
3. ALL RULES AND NOTES ASSOCIATED WITH REFERENCED TO-204AA OUTLINE SHALL APPLY.

DIM	INCHES		MILLIMETERS	
	MIN	MAX	MIN	MAX
A	1.550 REF		39.37 REF	
B	---	1.050	---	26.67
C	0.250	0.335	6.35	8.51
D	0.038	0.043	0.97	1.09
E	0.055	0.070	1.40	1.77
G	0.430 BSC		10.92 BSC	
H	0.215 BSC		5.46 BSC	
K	0.440	0.480	11.18	12.19
L	0.665 BSC		16.89 BSC	
N	---	0.830	---	21.08
Q	0.151	0.165	3.84	4.19
U	1.187 BSC		30.15 BSC	
V	0.131	0.188	3.33	4.77

#### STYLE 1:

1. BASE
  2. EMITTER
- CASE: COLLECTOR

**ON Semiconductor** and are registered trademarks of Semiconductor Components Industries, LLC (SCILLC). SCILLC reserves the right to make changes without further notice to any products herein. SCILLC makes no warranty, representation or guarantee regarding the suitability of its products for any particular purpose, nor does SCILLC assume any liability arising out of the application or use of any product or circuit, and specifically disclaims any and all liability, including without limitation special, consequential or incidental damages. "Typical" parameters which may be provided in SCILLC data sheets and/or specifications can and do vary in different applications and actual performance may vary over time. All operating parameters, including "Typicals" must be validated for each customer application by customer's technical experts. SCILLC does not convey any license under its patent rights nor the rights of others. SCILLC products are not designed, intended, or authorized for use as components in systems intended for surgical implant into the body, or other applications intended to support or sustain life, or for any other application in which the failure of the SCILLC product could create a situation where personal injury or death may occur. Should Buyer purchase or use SCILLC products for any such unintended or unauthorized application, Buyer shall indemnify and hold SCILLC and its officers, employees, subsidiaries, affiliates, and distributors harmless against all claims, costs, damages, and expenses, and reasonable attorney fees arising out of, directly or indirectly, any claim of personal injury or death associated with such unintended or unauthorized use, even if such claim alleges that SCILLC was negligent regarding the design or manufacture of the part. SCILLC is an Equal Opportunity/Affirmative Action Employer. This literature is subject to all applicable copyright laws and is not for resale in any manner.

#### PUBLICATION ORDERING INFORMATION

**LITERATURE FULFILLMENT:**  
Literature Distribution Center for ON Semiconductor  
P.O. Box 61312, Phoenix, Arizona 85062-1312 USA  
**Phone:** 480-829-7710 or 800-344-3860 Toll Free USA/Canada  
**Fax:** 480-829-7709 or 800-344-3867 Toll Free USA/Canada  
**Email:** orderlit@onsemi.com

**N. American Technical Support:** 800-282-9855 Toll Free  
USA/Canada

**Japan:** ON Semiconductor, Japan Customer Focus Center  
2-9-1 Kamimeguro, Meguro-ku, Tokyo, Japan 153-0051  
**Phone:** 81-3-5773-3850

**ON Semiconductor Website:** <http://onsemi.com>

**Order Literature:** <http://www.onsemi.com/litorder>

For additional information, please contact your local Sales Representative.