



# PESD2CAN

Order Code: PESD2CAN

Transient Voltage Suppressor

## Features

- 400 watts peak pulse power ( $t_p = 8/20\mu s$ )
- Response Time is Typically  $< 1\text{ ns}$
- Protects one bidirectional line or two unidirectional lines
- Working Voltages: 24V
- Low clamping voltages

## IEC COMPATIBILITY (EN61000-4)

- IEC 61000-4-2 (ESD)  $\pm 30\text{kV}$  (air),  $\pm 30\text{kV}$  (contact)
- IEC 61000-4-4 (EFT) 40A (5/50ns)
- IEC 61000-4-5 (Lightning) 8A (8/20 $\mu s$ )

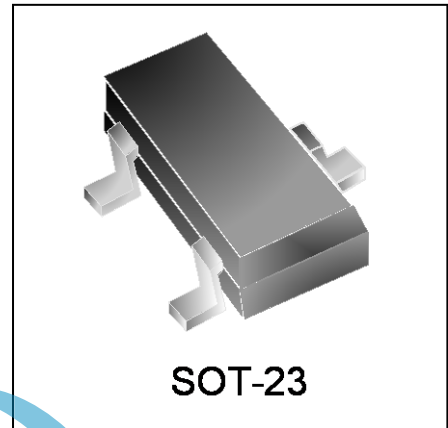

## Mechanical Characteristics

- JEDEC SOT-23 package
- Molding compound flammability rating:
- UL 94V-0
- Marking : Marking Code
- Packaging : Tape and Reel per EIA 481
- RoHS Compliant

## Applications

- Automotive Networks
- Control & Monitoring Systems
- Portable Electronics
- Set-Top Box
- Servers, Notebook, and Desktop PC
- Wireless Bus Protection

## Circuit Diagram

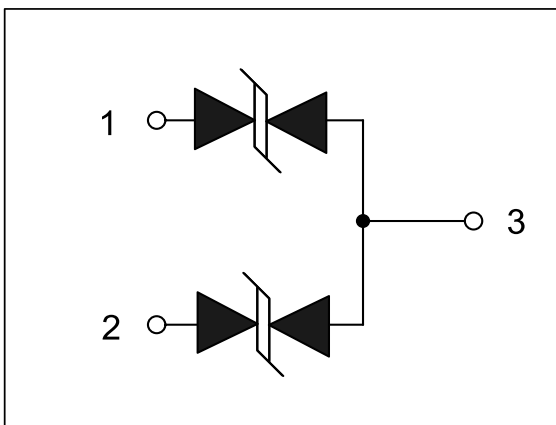

## Schematic & PIN Configuration

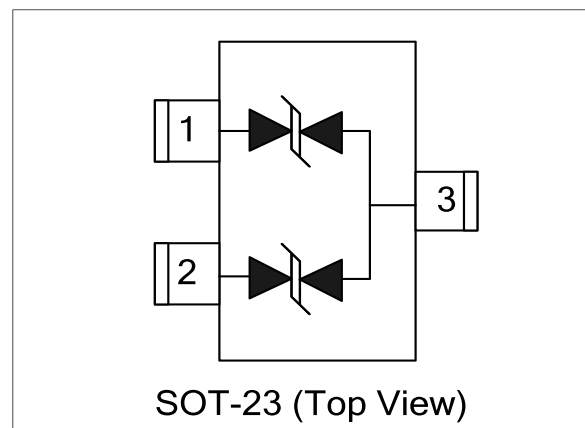

Absolute Maximum Rating			
Rating	Symbol	Value	Units
Peak Pulse Power ( $t_p=8/20\mu s$ )	$P_{PP}$	450	Watts
Peak Pulse Current ( $t_p=8/20\mu s$ )	$I_{PP}$	8	A
Operating Temperature	$T_J$	-55 to +125	$^{\circ}C$
Storage Temperature	$T_{STG}$	-55 to +150	$^{\circ}C$

**Electrical Parameters (T=25°C)**

Symbol	Parameter
$I_{PP}$	Reverse Peak Pulse Current
$V_C$	Clamping Voltage @ $I_{PP}$
$V_{RWM}$	Reverse Stand-Off Voltage
$I_R$	Reverse Leakage Current @ $V_{RWM}$
$V_{BR}$	Breakdown Voltage @ $I_T$
$I_T$	Test Current

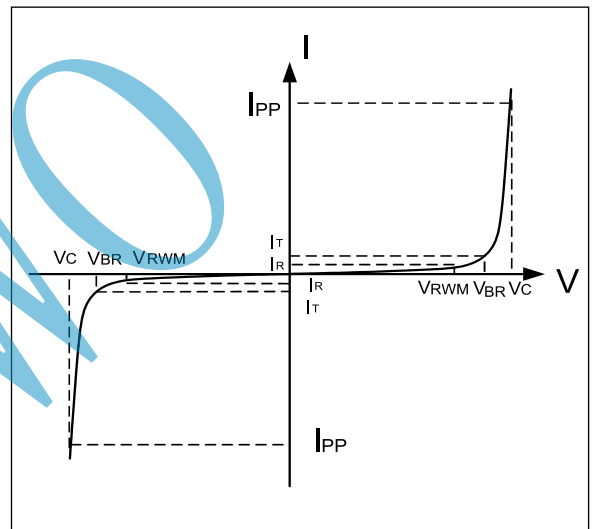

**Electrical Characteristics**

PESD2CAN						
Parameter	Symbol	Conditions	Minimum	Typical	Maximum	Units
Reverse Stand-Off Voltage	$V_{RWM}$				24	V
Reverse Breakdown Voltage	$V_{BR}$	$I_T=1mA$	26..7			V
Reverse Leakage Current	$I_R$	$V_{RWM}=24V, T=25^{\circ}C$			200	nA
Clamping Voltage	$V_C$	$I_{PP}=8A, t_p=8/20\mu s$		50	54	V
Dynamic Resistance <sup>1,2</sup>	$R_{DYN}$	TLP=0.2/100ns		0.4		$\Omega$
ESD Clamping Voltage <sup>1</sup>	$V_C$	$I_{PP} = 4A, t_p = 0.2/100ns$ (TLP)		38.0		V
ESD Clamping Voltage <sup>1</sup>	$V_C$	$I_{PP} = 16A, t_p = 0.2/100ns$ (TLP)		43.0		V
Junction Capacitance	$C_j$	Pin 1 to 3 or Pin 2 to 3 $V_R = 0V, f = 1MHz$		25	35	pF

Notes : 1、 TLP Setting :  $t_p=100ns, t_r=0.2ns, I_{TLP}$  and  $V_{TLP}$  sample window:  $t_1=70ns$  to  $t_2=90ns$ .  
 2、 Dynamic resistance calculated from  $I_{PP}=4A$  to  $I_{PP}=16A$  using "Best Fit"

Typical Characteristics

Figure 1: Peak Pulse Power vs. Pulse Time

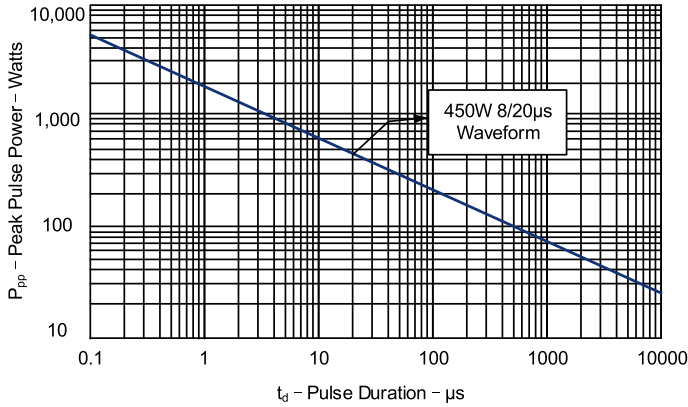

Figure 2: Power Derating Curve

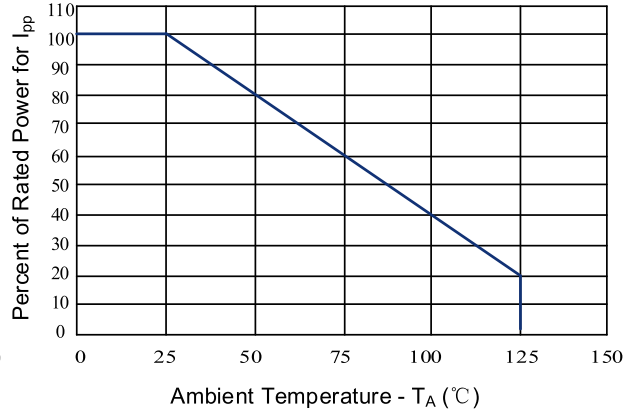

Figure 3: Clamping Voltage vs. Peak Pulse Current

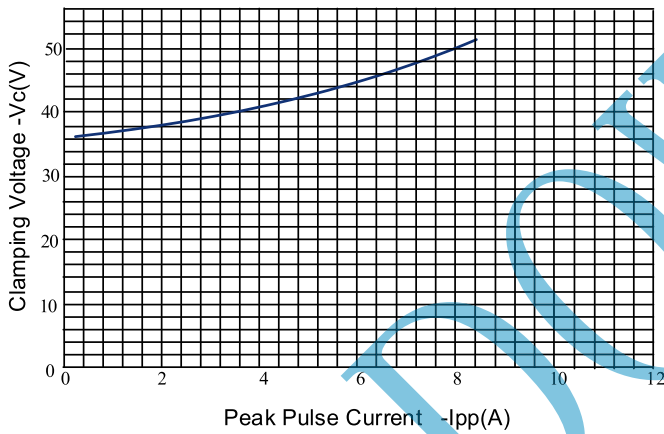

Figure 4: Normalized Junction Capacitance vs. Reverse Voltage

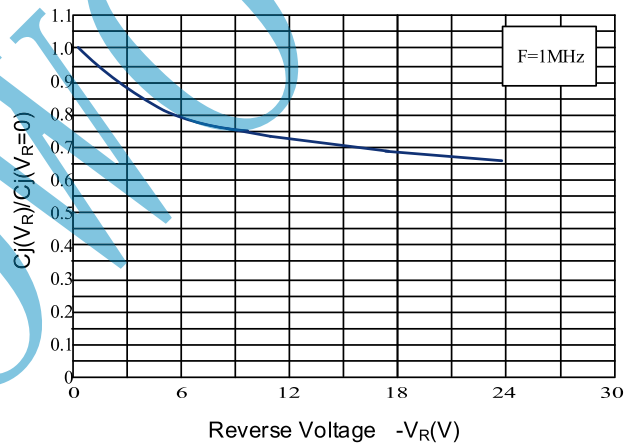

Figure 5: 8/20μs Pulse Waveform

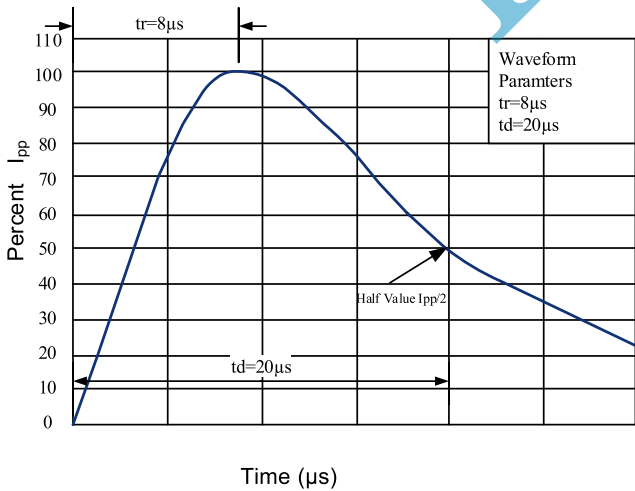
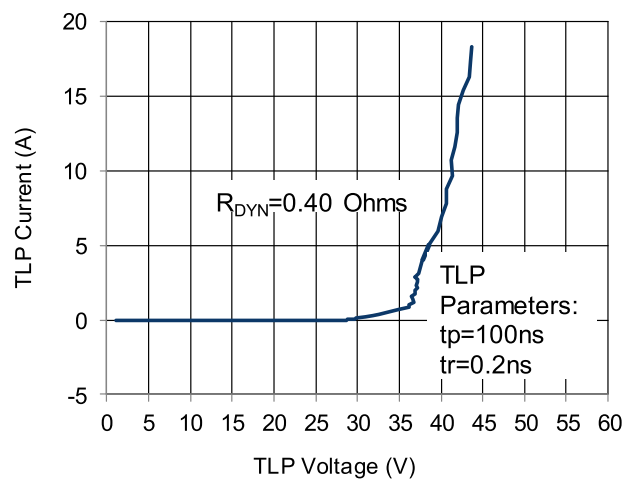
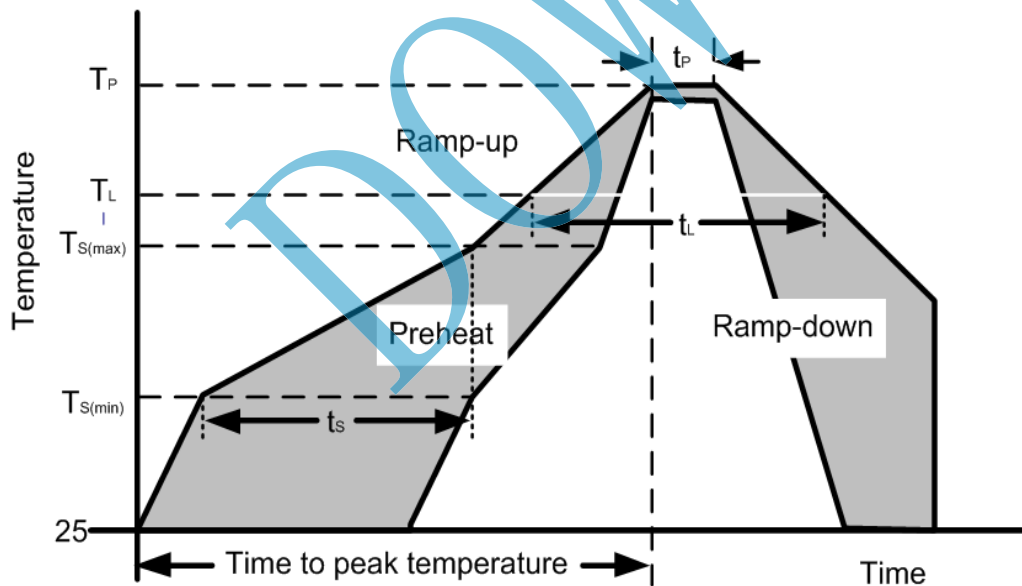

Figure 6: TLP I-V Curve



Soldering Parameters

Reflow Condition		Pb – Free assembly
Pre Heat	Temperature Min ( $T_{s(min)}$ )	150°C
	Temperature Max ( $T_{s(max)}$ )	200°C
	Time (min to max) ( $t_s$ )	60 – 190 secs
Average ramp up rate (Liquidus Temp) ( $T_L$ ) to peak		5°C/second max
$T_{s(max)}$ to $T_L$ —Ramp-up Rate		5°C/second max
Reflow	Temperature ( $T_L$ ) (Liquidus)	217°C
	Temperature ( $t_L$ )	60 – 150 seconds
Peak Temperature ( $T_P$ )		260+0/-5 °C
Time within actual peak Temperature ( $t_p$ )		20 – 40 seconds
Ramp-down Rate		5°C/second max
Time 25°C to peak Temperature ( $T_P$ )		8 minutes Max.
Do not exceed		280°C



Outline Drawing – SOT-23

### PACKAGE OUTLINE

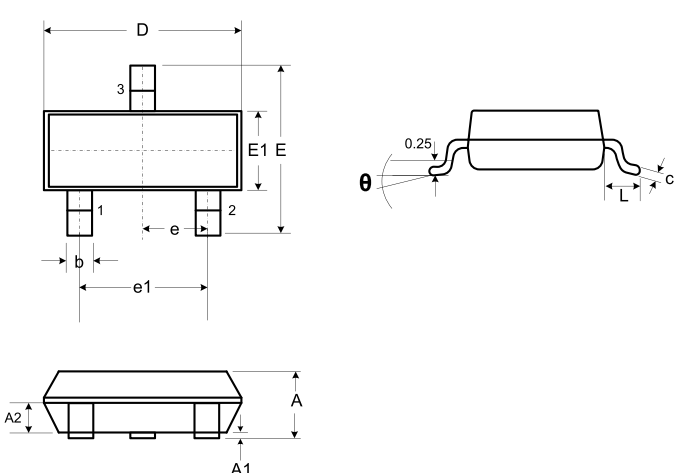

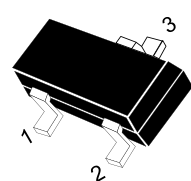

**SOT-23**

**DIMENSIONS**

SYMBOL	MILLIMETER		INCHES	
	MIN	MAX	MIN	MAX
A	0.90	1.15	0.035	0.045
A1	0.00	0.10	0.000	0.004
A2	0.60	0.70	0.0236	0.0275
b	0.30	0.50	0.012	0.020
c	0.08	0.15	0.003	0.006
D	2.80	3.00	0.110	0.118
E	2.25	2.55	0.089	0.100
E1	1.20	1.40	0.047	0.055
e	0.95 BSC		0.0374 BSC	
e1	1.80	2.00	0.071	0.079
L	0.30	0.50	0.012	0.020
θ	0	8°	0	8°

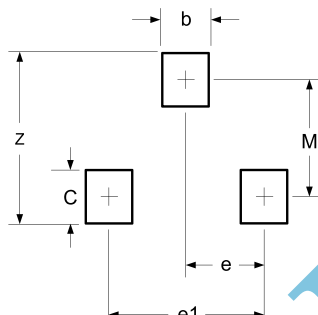

DIMENSIONS		
DIM	INCHES	MILLIMETERS
M	0.0795	2.02
C	0.0315	0.80
Z	0.111	2.82
e	0.037 BSC	0.95 BSC
e1	0.075 BSC	1.9 BSC
b	0.0315	0.80

**Notes**

1. Dimensioning and tolerances per ANSI Y14.5M, 1985.
2. Controlling Dimension: Inches
3. Pin 3 is the cathode (Unidirectional Only).
4. Dimensions are exclusive of mold flash and metal burrs.

**Marking Codes**

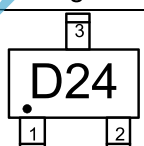
Part Number	Marking Code
PESD2CAN	

**Package Information**

Qty: 3k/Reel