

### HEXFET® Power MOSFET

- Surface Mount
- Available in Tape & Reel
- Dynamic dv/dt Rating
- P-Channel
- Fast Switching
- Ease of Paralleling
- Simple Drive Requirements

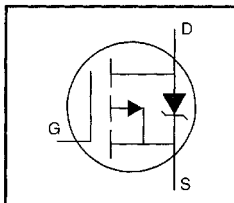

$$V_{DSS} = -200V$$

$$R_{DS(on)} = 1.5\Omega$$

$$I_D = -3.5A$$

### Description

The HEXFET technology is the key to International Rectifier's advanced line of power MOSFET transistors. The efficient geometry and unique processing of the HEXFET design achieve very low on-state resistance combined with high transconductance and extreme device ruggedness.

The SMD-220 is a surface mount power package capable of accommodating die sizes up to HEX-4. It provides the highest power capability and the lowest possible on-resistance in any existing surface mount package. The SMD-220 is suitable for high current applications because of its low internal connection resistance and can dissipate up to 2.0W in a typical surface mount application.

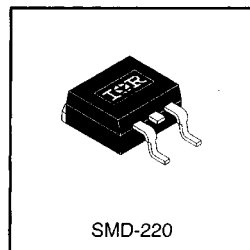
 DATA  
SHEETS

### Absolute Maximum Ratings

	Parameter	Max.	Units
$I_D @ T_C = 25^\circ C$	Continuous Drain Current, $V_{GS} @ -10 V$	-3.5	A
$I_D @ T_C = 100^\circ C$	Continuous Drain Current, $V_{GS} @ -10 V$	-2.0	
$I_{DM}$	Pulsed Drain Current ①	-14	
$P_D @ T_C = 25^\circ C$	Power Dissipation	40	W
$P_D @ T_A = 25^\circ C$	Power Dissipation (PCB Mount)**	3.0	
	Linear Derating Factor	0.32	W/°C
	Linear Derating Factor (PCB Mount)**	0.025	
$V_{GS}$	Gate-to-Source Voltage	$\pm 20$	V
$I_{LM}$	Inductive Current, Clamp	-14	A
dv/dt	Peak Diode Recovery dv/dt ③	-5.0	V/hs
$T_J, T_{STG}$	Junction and Storage Temperature Range	-55 to +150	°C
	Soldering Temperature, for 10 seconds	300 (1.6mm from case)	

### Thermal Resistance

	Parameter	Min.	Typ.	Max.	Units
$R_{\theta JC}$	Junction-to-Case	—	—	3.1	°C/W
$R_{\theta JA}$	Junction-to-Ambient (PCB mount)**	—	—	40	
$R_{\theta JA}$	Junction-to-Ambient	—	—	62	

\*\* When mounted on 1" square PCB (FR-4 or G-10 Material).  
For recommended footprint and soldering techniques refer to application note #AN-994.

## Electrical Characteristics @ $T_J = 25^\circ\text{C}$ (unless otherwise specified)

	Parameter	Min.	Typ.	Max.	Units	Test Conditions
$V_{(BR)DSS}$	Drain-to-Source Breakdown Voltage	-200	—	—	V	$V_{GS}=0V, I_D=-250\mu A$
$\Delta V_{(BR)DSS}/\Delta T_J$	Breakdown Voltage Temp. Coefficient	—	-0.22	—	V/ $^\circ\text{C}$	Reference to $25^\circ\text{C}$ , $I_D=-1\text{mA}$
$R_{DS(on)}$	Static Drain-to-Source On-Resistance	—	—	1.5	$\Omega$	$V_{GS}=-10V, I_D=-1.5A$ ④
$V_{GS(th)}$	Gate Threshold Voltage	-2.0	—	-4.0	V	$V_{DS}=V_{GS}, I_D=-250\mu A$
$g_{fs}$	Forward Transconductance	1.0	—	—	S	$V_{DS}=-50V, I_D=-1.5A$ ④
$I_{DSS}$	Drain-to-Source Leakage Current	—	—	-100	$\mu A$	$V_{DS}=-200V, V_{GS}=0V$
		—	—	-500		$V_{DS}=-160V, V_{GS}=0V, T_J=125^\circ\text{C}$
$I_{GSS}$	Gate-to-Source Forward Leakage	—	—	-100	nA	$V_{GS}=-20V$
	Gate-to-Source Reverse Leakage	—	—	100		$V_{GS}=20V$
$Q_g$	Total Gate Charge	—	—	22	nC	$I_D=-4.0A$
$Q_{GS}$	Gate-to-Source Charge	—	—	12		$V_{DS}=-160V$
$Q_{gd}$	Gate-to-Drain ("Miller") Charge	—	—	10		$V_{GS}=-10V$ See Fig. 6 and 12 ④
$t_{d(on)}$	Turn-On Delay Time	—	15	—	ns	$V_{DD}=100V$
$t_r$	Rise Time	—	25	—		$I_D=-1.5A$
$t_{d(off)}$	Turn-Off Delay Time	—	20	—		$R_G=50\Omega$
$t_f$	Fall Time	—	15	—		$R_D=67\Omega$ See Figure 10 ④
$L_D$	Internal Drain Inductance	—	4.5	—	nH	Between lead, 6 mm (0.25in.) from package and center of die contact
$L_S$	Internal Source Inductance	—	7.5	—		
$C_{iss}$	Input Capacitance	—	350	—	pF	$V_{GS}=0V$
$C_{oss}$	Output Capacitance	—	100	—		$V_{DS}=-25V$
$C_{riss}$	Reverse Transfer Capacitance	—	30	—		$f=1.0\text{MHz}$ See Figure 5



## Source-Drain Ratings and Characteristics

	Parameter	Min.	Typ.	Max.	Units	Test Conditions
$I_S$	Continuous Source Current (Body Diode)	—	—	-3.5	A	MOSFET symbol showing the integral reverse p-n junction diode.
$I_{SM}$	Pulsed Source Current (Body Diode) ①	—	—	-14		
$V_{SD}$	Diode Forward Voltage	—	—	-7.0	V	$T_J=25^\circ\text{C}, I_S=-3.5A, V_{GS}=0V$ ④
$t_{rr}$	Reverse Recovery Time	—	300	450	ns	$T_J=25^\circ\text{C}, I_F=-3.5A$
$Q_{rr}$	Reverse Recovery Charge	—	1.9	2.9	$\mu C$	$di/dt=100A/\mu s$ ④
$t_{on}$	Forward Turn-On Time	Intrinsic turn-on time is negligible (turn-on is dominated by $L_S+L_D$ )				

### Notes:

- ① Repetitive rating; pulse width limited by max. junction temperature (See Figure 11)
- ② Not Applicable
- ③  $I_{SD} \leq -3.5A, di/dt \leq 95A/\mu s, V_{DD} \leq V_{(BR)DSS}, T_J \leq 150^\circ\text{C}$
- ④ Pulse width  $\leq 300 \mu s$ ; duty cycle  $\leq 2\%$ .

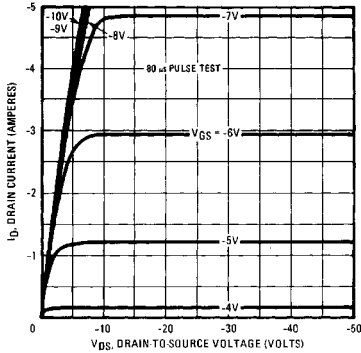

Fig. 1 — Typical Output Characteristics

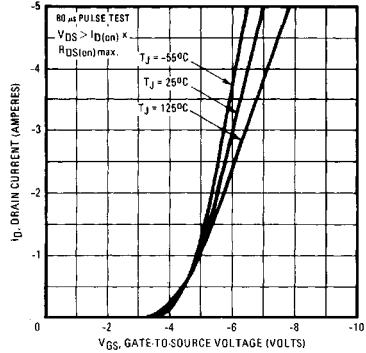

Fig. 2 — Typical Transfer Characteristics

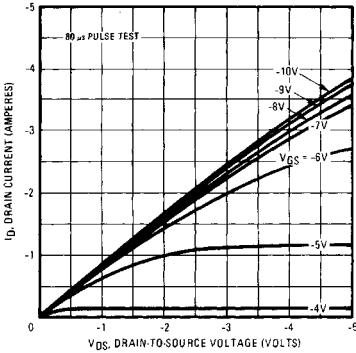

Fig. 3 — Typical Saturation Characteristics

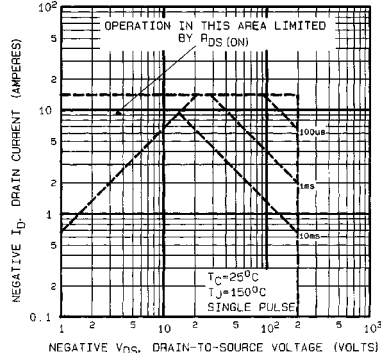

Fig. 4 — Maximum Safe Operating Area

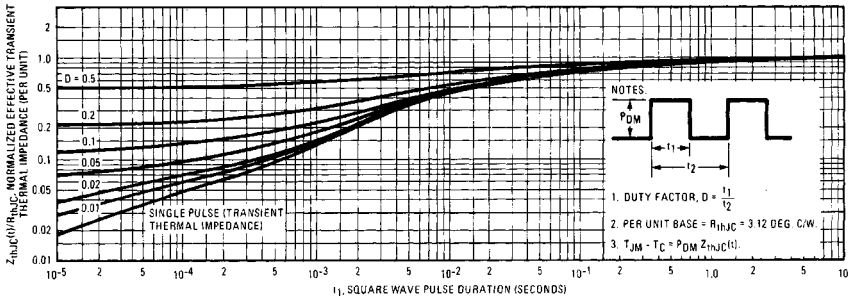
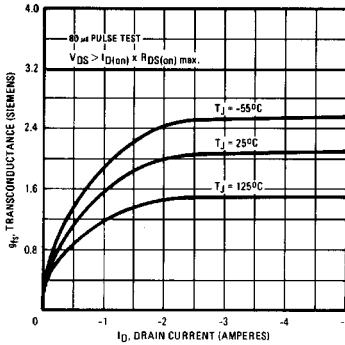
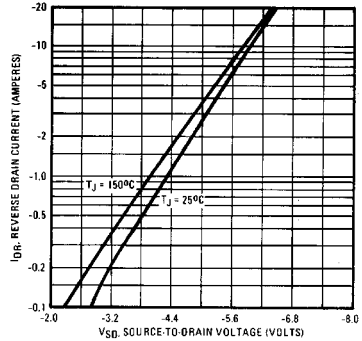

Fig. 5 — Maximum Effective Transient Thermal Impedance, Junction-to-Case Vs. Pulse Duration

DATA SHEETS



**Fig. 6 — Typical Transconductance Vs. Drain Current**



**Fig. 7 — Typical Source-Drain Diode Forward Voltage**

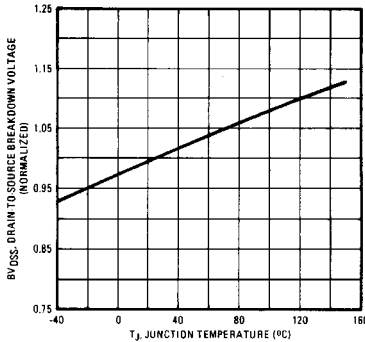

**Fig. 8 — Breakdown Voltage Vs. Temperature**

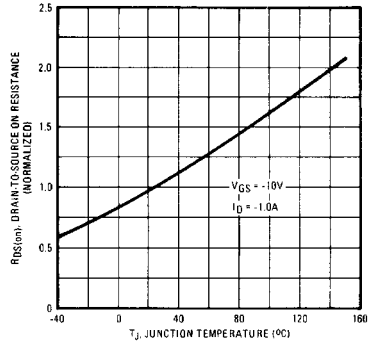

**Fig. 9 — Normalized On-Resistance Vs. Temperature**

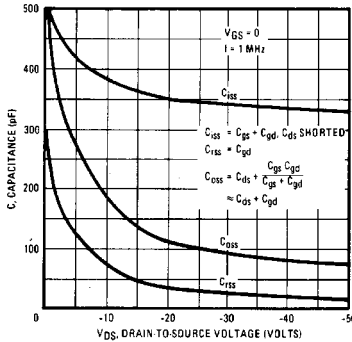

**Fig. 10 — Typical Capacitance Vs. Drain-to-Source Voltage**

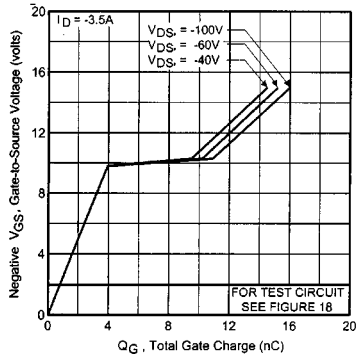

**Fig. 11 — Typical Gate Charge Vs. Gate-to-Source Voltage**

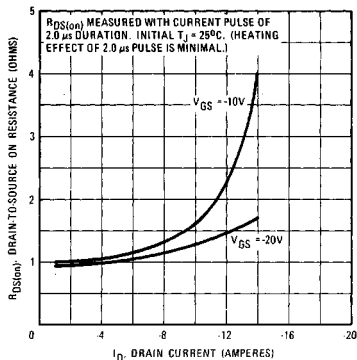

Fig. 12 — Typical On-Resistance Vs. Drain Current

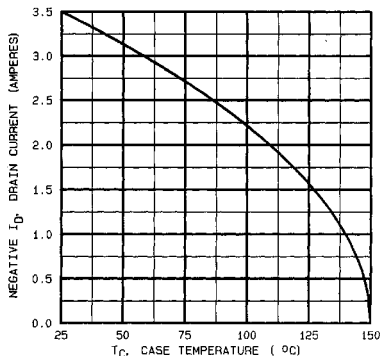

Fig. 13 — Maximum Drain Current Vs. Case Temperature

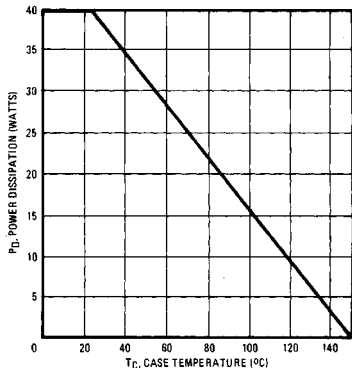

Fig. 14 — Power Vs. Temperature Derating Curve

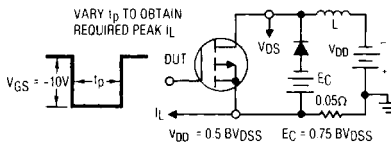

Fig. 15 — Clamped Inductive Test Circuit

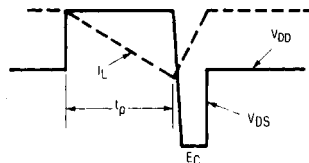

Fig. 16 — Clamped Inductive Waveforms

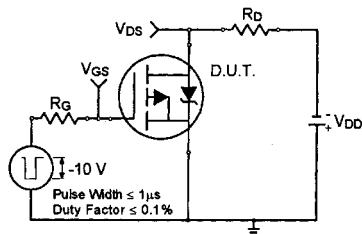

Fig. 17a — Switching Time Test Circuit

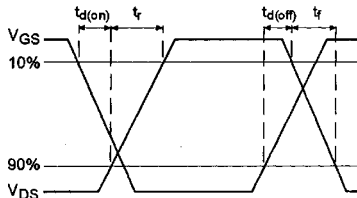

Fig. 17b — Switching Time Waveforms

DATA SHEETS

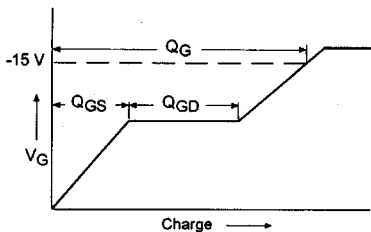

Fig. 18a — Basic Gate Charge Waveform

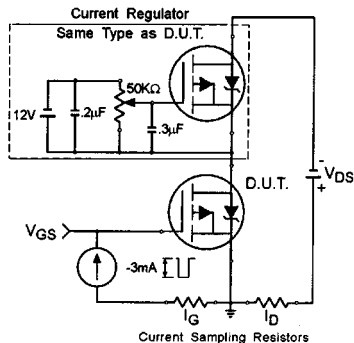

Fig. 18b — Gate Charge Test Circuit

**Appendix A:** Figure 14, Peak Diode Recovery  $dv/dt$  Test Circuit – See page 1506

**Appendix B:** Package Outline Mechanical Drawing – See page 1507

**Appendix C:** Part Marking Information – See page 1515

**Appendix D:** Tape & Reel Information – See page 1519

This datasheet has been download from:

[www.datasheetcatalog.com](http://www.datasheetcatalog.com)

Datasheets for electronics components.