



Power MOSFET

PRODUCT SUMMARY	
V _{DS} (V)	- 50
R _{DS(on)} (Ω)	V _{GS} = - 10 V 0.28
Q _g (Max.) (nC)	14
Q _{gs} (nC)	6.5
Q _{gd} (nC)	6.5
Configuration	Single

FEATURES

- Surface Mountable (Order As IRFR9020, SiHFR9020)
- Straight Lead Option (Order As IRFU9020, SiHFU9020)
- Repetitive Avalanche Ratings
- Dynamic dV/dt Rating
- Simple Drive Requirements
- Ease of Paralleling
- Material categorization: For definitions of compliance please see www.vishay.com/doc?99912



RoHS COMPLIANT
HALOGEN FREE Available

DESCRIPTION

The power MOSFET technology is the key to Vishay's advanced line of power MOSFET transistors. The efficient geometry and unique processing of this latest "State of the Art" design achieves: very low on-state resistance combined with high transconductance; superior reverse energy and diode recovery dV/dt.

The power MOSFET transistors also feature all of the well established advantages of MOSFET'S such as voltage control, very fast switching, ease of paralleling and temperature stability of the electrical parameters. Surface mount packages enhance circuit performance by reducing stray inductances and capacitance. The TO-252 surface mount package brings the advantages of power MOSFET'S to high volume applications where PC board surface mounting is desirable. The surface mount option IRFR9020, SiHFR9020 is provided on 16mm tape. The straight lead option IRFU9020, SiHFU9020 of the device is called the IPAK (TO-251).

They are well suited for applications where limited heat dissipation is required such as, computers and peripherals, telecommunication equipment, DC/DC converters, and a wide range of consumer products.

DPAK (TO-252)

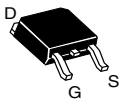

IPAK (TO-251)

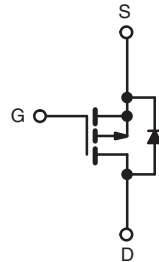
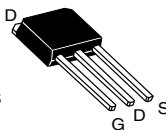

P-Channel MOSFET

ORDERING INFORMATION

Package	DPAK (TO-252)	DPAK (TO-252)	DPAK (TO-252)	IPAK (TO-251)
Lead (Pb)-free and Halogen-free	SiHFR9020-GE3	SiHFR9020TR-GE3 ^a	SiHFR9020TRL-GE3 ^a	SiHFU9020-GE3
Lead (Pb)-free	IRFR9020PbF	IRFR9020TRPbF ^a	IRFR9020TRLPbF ^a	IRFU9020PbF
	SiHFR9020-E3	SiHFR9020T-E3 ^a	SiHFR9020TL-E3 ^a	SiHFU9020-E3

Note

a. See device orientation.

ABSOLUTE MAXIMUM RATINGS (T_C = 25 °C, unless otherwise noted)

PARAMETER	SYMBOL	LIMIT	UNIT
Drain-Source Voltage	V _{DS}	- 50	V
Gate-Source Voltage	V _{GS}	± 20	
Continuous Drain Current	V _{GS} at - 10 V	T _C = 25 °C	- 9.9
		T _C = 100 °C	- 6.3
Pulsed Drain Current ^a	I _{DM}	- 40	A
Linear Derating Factor		0.33	W/°C
Single Pulse Avalanche Energy ^b	E _{AS}	250	mJ
Repetitive Avalanche Current ^a	I _{AR}	- 9.9	A
Repetitive Avalanche Energy ^a	E _{AR}	4.2	mJ
Maximum Power Dissipation	P _D	T _C = 25 °C	42
Peak Diode Recovery dV/dt ^c			dV/dt
Operating Junction and Storage Temperature Range	T _J , T _{stg}	- 55 to + 150	°C
Soldering Recommendations (Peak Temperature) ^d	for 10 s	300	



Notes

- Repetitive rating; pulse width limited by maximum junction temperature (see fig. 16).
- V_{DD} = - 25 V, Starting T_J = 25 °C, L = 5.1 mH, R_g = 25 Ω, Peak I_L = - 9.9 A
- I_{SD} ≤ - 9.9 A, di/dt ≤ - 120 A/μs, V_{DD} ≤ 40 V, T_J ≤ 150 °C.
- 0.063" (1.6 mm) from case.
- When mounted on 1" square PCB (FR-4 or G-10 material).



THERMAL RESISTANCE RATINGS					
PARAMETER	SYMBOL	MIN.	TYP.	MAX.	UNIT
Maximum Junction-to-Ambient	R_{thJA}	-	-	110	°C/W
Case-to-Sink	R_{thCS}	-	1.7	-	
Maximum Junction-to-Case (Drain)	R_{thJC}	-	-	3.0	

SPECIFICATIONS ($T_J = 25\text{ }^\circ\text{C}$, unless otherwise noted)

PARAMETER	SYMBOL	TEST CONDITIONS	MIN.	TYP.	MAX.	UNIT
Static						
Drain-Source Breakdown Voltage	V_{DS}	$V_{GS} = 0\text{ V}, I_D = -250\text{ }\mu\text{A}$	- 50	-	-	V
Gate-Source Threshold Voltage	$V_{GS(th)}$	$V_{DS} = V_{GS}, I_D = -250\text{ }\mu\text{A}$	- 2.0	-	- 4.0	V
Gate-Source Leakage	I_{GSS}	$V_{GS} = \pm 20\text{ V}$	-	-	± 500	nA
Zero Gate Voltage Drain Current	I_{DSS}	$V_{DS} = \text{max. rating}, V_{GS} = 0\text{ V}$	-	-	250	μA
		$V_{DS} = 0.8 \times \text{max. rating}, V_{GS} = 0\text{ V}, T_J = 125\text{ }^\circ\text{C}$	-	-	1000	
Drain-Source On-State Resistance	$R_{DS(on)}$	$V_{GS} = -10\text{ V}, I_D = 5.7\text{ A}^b$	-	0.20	0.28	Ω
Forward Transconductance	g_{fs}	$V_{DS} \leq -50\text{ V}, I_{DS} = -5.7\text{ A}$	2.3	3.5	-	S
Dynamic						
Input Capacitance	C_{iss}	$V_{GS} = 0\text{ V}, V_{DS} = -25\text{ V}, f = 1.0\text{ MHz}, \text{ see fig. 9}$	-	490	-	pF
Output Capacitance	C_{oss}		-	320	-	
Reverse Transfer Capacitance	C_{rss}		-	70	-	
Total Gate Charge	Q_g	$V_{GS} = -10\text{ V}, I_D = -9.7\text{ A}, V_{DS} = 0.8 \times \text{max. rating}, \text{ see fig. 18 (Independent operating temperature)}$	-	9.4	14	nC
Gate-Source Charge	Q_{gs}		-	4.3	6.5	
Gate-Drain Charge	Q_{gd}		-	4.3	6.5	
Turn-On Delay Time	$t_{d(on)}$	$V_{DD} = -25\text{ V}, I_D = -9.7\text{ A}, R_g = 18\text{ }\Omega, R_D = 2.4\text{ }\Omega, \text{ see fig. 17 (Independent operating temperature)}$	-	8.2	12	ns
Rise Time	t_r		-	57	66	
Turn-Off Delay Time	$t_{d(off)}$		-	12	18	
Fall Time	t_f		-	25	38	
Internal Drain Inductance	L_D	Between lead, 6 mm (0.25") from package and center of die contact. 	-	4.5	-	nH
Internal Source Inductance	L_S		-	7.5	-	
Drain-Source Body Diode Characteristics						
Continuous Source-Drain Diode Current	I_S	MOSFET symbol showing the integral reverse p - n junction diode 	-	-	- 9.9	A
Pulsed Diode Forward Current ^a	I_{SM}		-	-	- 40	
Body Diode Voltage	V_{SD}	$T_J = 25\text{ }^\circ\text{C}, I_S = -9.9\text{ A}, V_{GS} = 0\text{ V}^b$	-	-	- 6.3	V
Body Diode Reverse Recovery Time	t_{rr}	$T_J = 25\text{ }^\circ\text{C}, I_F = -9.7\text{ A}, di/dt = 100\text{ A}/\mu\text{s}^b$	56	110	280	ns
Body Diode Reverse Recovery Charge	Q_{rr}		0.17	0.34	0.85	nC
Forward Turn-On Time	t_{on}	Intrinsic turn-on time is negligible (turn-on is dominated by L_S and L_D)				

Notes

- a. Repetitive rating; pulse width limited by maximum junction temperature (see fig. 16).
- b. Pulse width $\leq 300\text{ }\mu\text{s}$; duty cycle $\leq 2\%$.



TYPICAL CHARACTERISTICS (25 °C, unless otherwise noted)



Fig. 1 - Typical Output Characteristics



Fig. 4 - Maximum Safe Operating Area

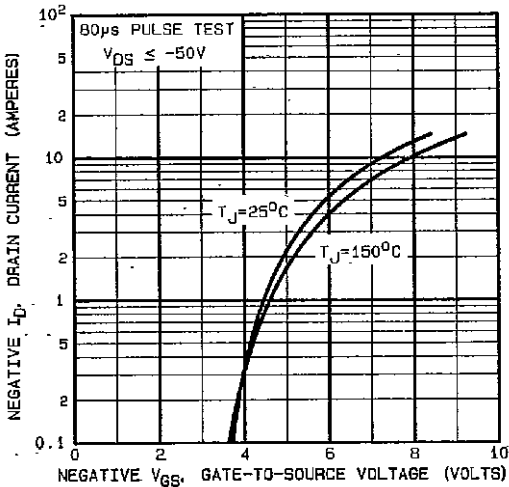

Fig. 2 - Typical Transfer Characteristics



Fig. 5 - Typical Transconductance vs. Drain Current



Fig. 3 - Typical Saturation Characteristics



Fig. 6 - Typical Source-Drain Diode Forward Voltage



Fig. 7 - Breakdown Voltage vs. Temperature



Fig. 9 - Typical Capacitance vs. Drain-to-Source Voltage



Fig. 8 - Normalized On-Resistance vs. Temperature

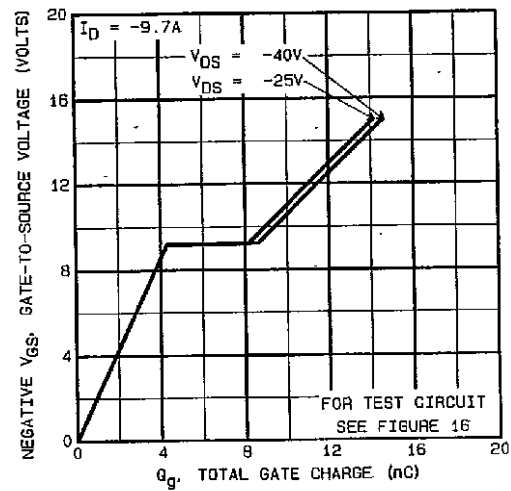

Fig. 10 - Typical Gate Charge vs. Gate-to-Source Voltage



Fig. 11 - Typical On-Resistance vs. Drain Current

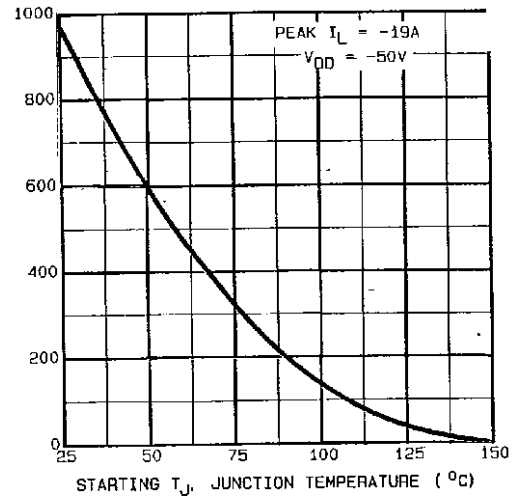

Fig. 13 - Maximum Avalanche vs. Starting Junction Temperature



Fig. 12 - Maximum Drain Current vs. Case Temperature



Fig. 14 - Unclamped Inductive Test Circuit

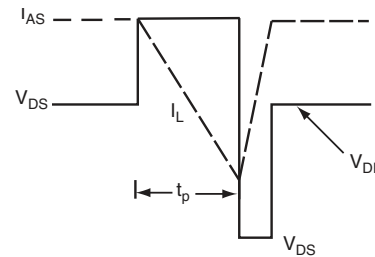

Fig. 15 - Unclamped Inductive Waveforms

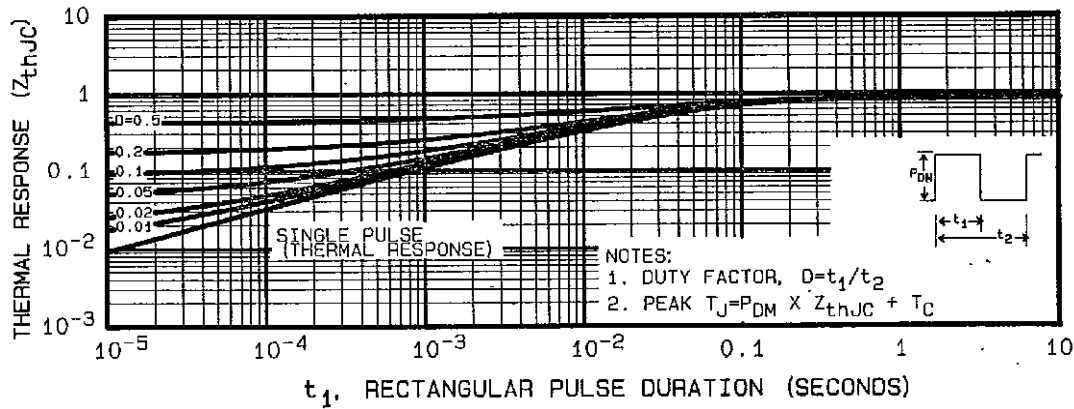

Fig. 16 - Maximum Effective Transient Thermal Impedance, Junction-to-Case vs. Pulse Duration



Fig. 17 - Switching Time Waveforms

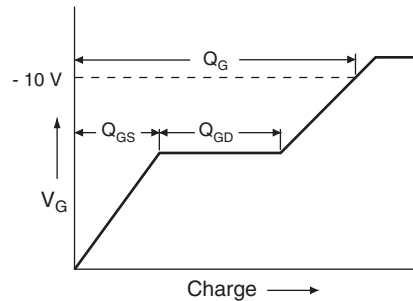

Fig. 19 - Basic Gate Charge Waveform

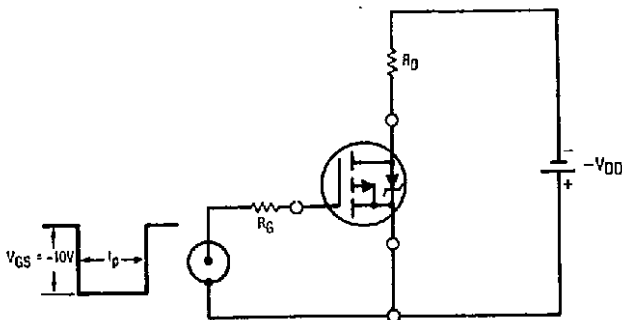

Fig. 18 - Switching Time Test Circuit

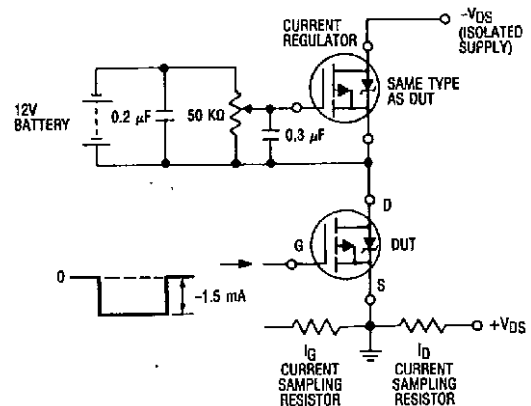
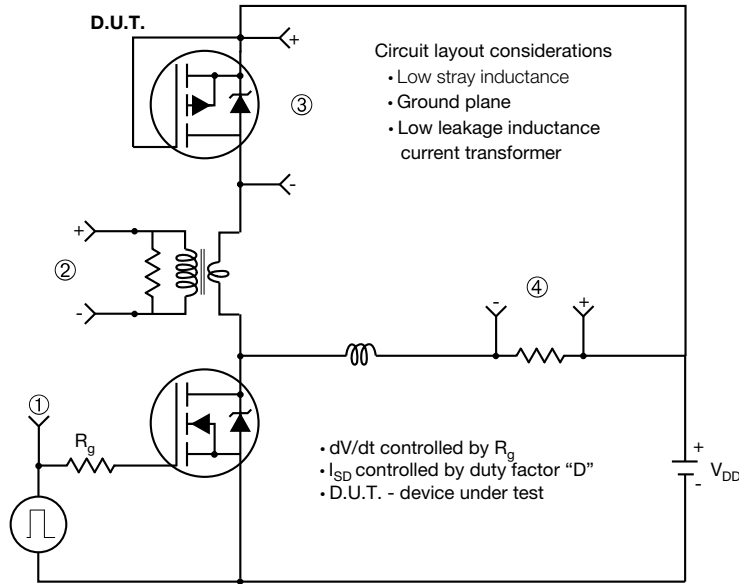

Fig. 20 - Gate Charge Test Circuit

Peak Diode Recovery dV/dt Test Circuit



Note
• Compliment N-Channel of D.U.T. for driver



Note
a. $V_{GS} = -5\text{ V}$ for logic level and -3 V drive devices

Fig. 21 - For P-Channel

Vishay Siliconix maintains worldwide manufacturing capability. Products may be manufactured at one of several qualified locations. Reliability data for Silicon Technology and Package Reliability represent a composite of all qualified locations. For related documents such as package/tape drawings, part marking, and reliability data, see www.vishay.com/ppg?90350.



TO-252AA Case Outline

VERSION 1: FACILITY CODE = Y



DIM.	MILLIMETERS	
	MIN.	MAX.
A	2.18	2.38
A1	-	0.127
b	0.64	0.88
b2	0.76	1.14
b3	4.95	5.46
C	0.46	0.61
C2	0.46	0.89
D	5.97	6.22
D1	4.10	-
E	6.35	6.73
E1	4.32	-
H	9.40	10.41
e	2.28 BSC	
e1	4.56 BSC	
L	1.40	1.78
L3	0.89	1.27
L4	-	1.02
L5	1.01	1.52

Note

- Dimension L3 is for reference only



VERSION 2: FACILITY CODE = N



MILLIMETERS		
DIM.	MIN.	MAX.
A	2.18	2.39
A1	-	0.13
b	0.65	0.89
b1	0.64	0.79
b2	0.76	1.13
b3	4.95	5.46
c	0.46	0.61
c1	0.41	0.56
c2	0.46	0.60
D	5.97	6.22
D1	5.21	-
E	6.35	6.73
E1	4.32	-
e	2.29 BSC	
H	9.94	10.34

MILLIMETERS		
DIM.	MIN.	MAX.
L	1.50	1.78
L1	2.74 ref.	
L2	0.51 BSC	
L3	0.89	1.27
L4	-	1.02
L5	1.14	1.49
L6	0.65	0.85
θ	0°	10°
θ_1	0°	15°
θ_2	25°	35°

Notes

- Dimensioning and tolerance confirm to ASME Y14.5M-1994
- All dimensions are in millimeters. Angles are in degrees
- Heat sink side flash is max. 0.8 mm
- Radius on terminal is optional

ECN: E19-0649-Rev. Q, 16-Dec-2019
DWG: 5347

TO-251AA (HIGH VOLTAGE)



DIM.	MILLIMETERS		INCHES	
	MIN.	MAX.	MIN.	MAX.
A	2.18	2.39	0.086	0.094
A1	0.89	1.14	0.035	0.045
b	0.64	0.89	0.025	0.035
b1	0.65	0.79	0.026	0.031
b2	0.76	1.14	0.030	0.045
b3	0.76	1.04	0.030	0.041
b4	4.95	5.46	0.195	0.215
c	0.46	0.61	0.018	0.024
c1	0.41	0.56	0.016	0.022
c2	0.46	0.86	0.018	0.034
D	5.97	6.22	0.235	0.245

DIM.	MILLIMETERS		INCHES	
	MIN.	MAX.	MIN.	MAX.
D1	5.21	-	0.205	-
E	6.35	6.73	0.250	0.265
E1	4.32	-	0.170	-
e	2.29 BSC		2.29 BSC	
L	8.89	9.65	0.350	0.380
L1	1.91	2.29	0.075	0.090
L2	0.89	1.27	0.035	0.050
L3	1.14	1.52	0.045	0.060
theta1	0'	15'	0'	15'
theta2	25'	35'	25'	35'

ECN: S-82111-Rev. A, 15-Sep-08
DWG: 5968

Notes

1. Dimensioning and tolerancing per ASME Y14.5M-1994.
2. Dimension are shown in inches and millimeters.
3. Dimension D and E do not include mold flash. Mold flash shall not exceed 0.13 mm (0.005") per side. These dimensions are measured at the outermost extremes of the plastic body.
4. Thermal pad contour optional with dimensions b4, L2, E1 and D1.
5. Lead dimension uncontrolled in L3.
6. Dimension b1, b3 and c1 apply to base metal only.
7. Outline conforms to JEDEC outline TO-251AA.

RECOMMENDED MINIMUM PADS FOR DPAK (TO-252)



Recommended Minimum Pads
Dimensions in Inches/(mm)

[Return to Index](#)



Disclaimer

ALL PRODUCT, PRODUCT SPECIFICATIONS AND DATA ARE SUBJECT TO CHANGE WITHOUT NOTICE TO IMPROVE RELIABILITY, FUNCTION OR DESIGN OR OTHERWISE.

Vishay Intertechnology, Inc., its affiliates, agents, and employees, and all persons acting on its or their behalf (collectively, "Vishay"), disclaim any and all liability for any errors, inaccuracies or incompleteness contained in any datasheet or in any other disclosure relating to any product.

Vishay makes no warranty, representation or guarantee regarding the suitability of the products for any particular purpose or the continuing production of any product. To the maximum extent permitted by applicable law, Vishay disclaims (i) any and all liability arising out of the application or use of any product, (ii) any and all liability, including without limitation special, consequential or incidental damages, and (iii) any and all implied warranties, including warranties of fitness for particular purpose, non-infringement and merchantability.

Statements regarding the suitability of products for certain types of applications are based on Vishay's knowledge of typical requirements that are often placed on Vishay products in generic applications. Such statements are not binding statements about the suitability of products for a particular application. It is the customer's responsibility to validate that a particular product with the properties described in the product specification is suitable for use in a particular application. Parameters provided in datasheets and / or specifications may vary in different applications and performance may vary over time. All operating parameters, including typical parameters, must be validated for each customer application by the customer's technical experts. Product specifications do not expand or otherwise modify Vishay's terms and conditions of purchase, including but not limited to the warranty expressed therein.

Except as expressly indicated in writing, Vishay products are not designed for use in medical, life-saving, or life-sustaining applications or for any other application in which the failure of the Vishay product could result in personal injury or death. Customers using or selling Vishay products not expressly indicated for use in such applications do so at their own risk. Please contact authorized Vishay personnel to obtain written terms and conditions regarding products designed for such applications.

No license, express or implied, by estoppel or otherwise, to any intellectual property rights is granted by this document or by any conduct of Vishay. Product names and markings noted herein may be trademarks of their respective owners.