

## +36V, +150mA, Ultralow-Noise, Positive LINEAR REGULATOR

### FEATURES

- **Input Voltage Range: +3V to +36V**
- **Noise:**
  - 12.7 $\mu$ V<sub>RMS</sub> (20Hz to 20kHz)
  - 15.4 $\mu$ V<sub>RMS</sub> (10Hz to 100kHz)
- **Power-Supply Ripple Rejection:**
  - 72dB (120Hz)
  - $\geq$  52dB (10Hz to 400kHz)
- **Adjustable Output: +1.194V to +33V**
- **Output Current: 150mA**
- **Dropout Voltage: 260mV at 100mA**
- **Stable with Ceramic Capacitors  $\geq$  2.2 $\mu$ F**
- **CMOS Logic-Level-Compatible Enable Pin**
- **Built-In, Fixed, Current-Limit and Thermal Shutdown Protection**
- **Available in High Thermal Performance MSOP-8 PowerPAD™ Package**
- **Operating Temperature Range: –40°C to +125°C**

### APPLICATIONS

- **Supply Rails for Op Amps, DACs, ADCs, and Other High-Precision Analog Circuitry**
- **Audio**
- **Post DC/DC Converter Regulation and Ripple Filtering**
- **Test and Measurement**
- **RX, TX, and PA Circuitry**
- **Industrial Instrumentation**
- **Base Stations and Telecom Infrastructure**

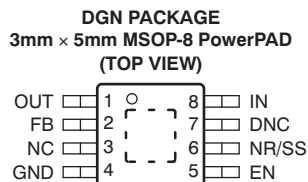

### DESCRIPTION

The TPS7A49xx series of devices are positive, high-voltage (+36V), ultralow noise (15.4 $\mu$ V<sub>RMS</sub>, 72dB PSRR) linear regulators capable of sourcing a load of 150mA.

These linear regulators include a CMOS logic-level-compatible enable pin and capacitor-programmable soft-start function that allows for customized power-management schemes. Other features available include built-in current limit and thermal shutdown protection to safeguard the device and system during fault conditions.

The TPS7A49xx family is designed using bipolar technology, and is ideal for high-accuracy, high-precision instrumentation applications where clean voltage rails are critical to maximize system performance. This design makes it an excellent choice to power operational amplifiers, analog-to-digital converters (ADCs), digital-to-analog converters (DACs), and other high-performance analog circuitry.

In addition, the TPS7A49xx family of linear regulators is suitable for post dc/dc converter regulation. By filtering out the output voltage ripple inherent to dc/dc switching conversion, maximum system performance is provided in sensitive instrumentation, test and measurement, audio, and RF applications.

For applications where both positive and negative high-performance rails are required, consider TI's [TPS7A30xx](#) family of negative high-voltage, ultralow-noise linear regulators as well.

### Typical Application

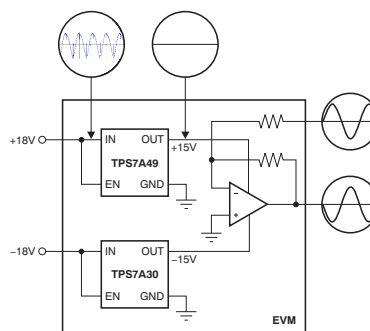

### Post DC/DC Converter Regulation for High-Performance Analog Circuitry



Please be aware that an important notice concerning availability, standard warranty, and use in critical applications of Texas Instruments semiconductor products and disclaimers thereto appears at the end of this data sheet.

PowerPAD is a trademark of Texas Instruments.

All other trademarks are the property of their respective owners.



This integrated circuit can be damaged by ESD. Texas Instruments recommends that all integrated circuits be handled with appropriate precautions. Failure to observe proper handling and installation procedures can cause damage.

ESD damage can range from subtle performance degradation to complete device failure. Precision integrated circuits may be more susceptible to damage because very small parametric changes could cause the device not to meet its published specifications.

### ORDERING INFORMATION<sup>(1)</sup>

PRODUCT	V <sub>OUT</sub>
TPS7A49xx yyy z	<b>XX</b> is nominal output voltage (01 = Adjustable). <sup>(2)</sup> <b>YYY</b> is package designator. <b>Z</b> is package quantity.

(1) For the most current package and ordering information see the Package Option Addendum at the end of this document, or visit the device product folder on [www.ti.com](http://www.ti.com).

(2) For fixed -1.2V operation, tie FB to OUT.

### ABSOLUTE MAXIMUM RATINGS<sup>(1)</sup>

Over operating free-air temperature range (unless otherwise noted).

		VALUE		UNIT
		MIN	MAX	
Voltage	IN pin to GND pin	-0.3	+36	V
	OUT pin to GND pin	-0.3	+33	V
	OUT pin to IN pin	-36	+0.3	V
	FB pin to GND pin	-0.3	+2	V
	FB pin to IN pin	-36	+0.3	V
	EN pin to IN pin	-36	0.3	V
	EN pin to GND pin	-0.3	+36	V
	NR/SS pin to IN pin	-36	+0.3	V
Current	NR/SS pin to GND pin	-0.3	+2	V
	Peak output	Internally limited		
Temperature	Operating virtual junction, T <sub>J</sub>	-40	+125	°C
	Storage, T <sub>stg</sub>	-65	+150	°C
Electrostatic discharge rating	Human body model (HBM)	1500		V
	Charged device model (CDM)	500		V

(1) Stresses beyond those listed under *Absolute Maximum Ratings* may cause permanent damage to the device. These are stress ratings only, and functional operation of the device at these or any other conditions beyond those indicated is not implied. Exposure to absolute-maximum rated conditions for extended periods may affect device reliability.

### THERMAL INFORMATION

THERMAL METRIC <sup>(1)</sup>		TPS7A49xx	UNITS
		DGN	
		8 PINS	
θ <sub>JA</sub>	Junction-to-ambient thermal resistance	55.09	°C/W
θ <sub>JC(top)</sub>	Junction-to-case(top) thermal resistance	8.47	
θ <sub>JB</sub>	Junction-to-board thermal resistance	—	
ψ <sub>JT</sub>	Junction-to-top characterization parameter	0.36	
ψ <sub>JB</sub>	Junction-to-board characterization parameter	14.6	
θ <sub>JC(bottom)</sub>	Junction-to-case(bottom) thermal resistance	—	

(1) For more information about traditional and new thermal metrics, see the *IC Package Thermal Metrics* application report, [SPRA953](http://www.ti.com/lit/spr953).

### DISSIPATION RATINGS

BOARD	PACKAGE	R <sub>θJA</sub>	R <sub>θJC</sub>	DERATING FACTOR ABOVE T <sub>A</sub> = +25°C	T <sub>A</sub> ≤ +25°C POWER RATING	T <sub>A</sub> = +70°C POWER RATING	T <sub>A</sub> = +85°C POWER RATING
High-K <sup>(1)</sup>	DGN	55.9°C/W	8.47°C/W	16.6mW/°C	1.83W	1.08W	0.833W

(1) The JEDEC High-K (2s2p) board design used to derive this data was a 3-inch x 3-inch multilayer board with 2-ounce internal power and ground planes and 2-ounce copper traces on top and bottom of the board.

**ELECTRICAL CHARACTERISTICS**

At  $T_J = -40^\circ\text{C}$  to  $+125^\circ\text{C}$ ,  $V_{IN} = V_{OUT(NOM)} + 1.0\text{V}$  or  $V_{IN} = 3.0\text{V}$  (whichever is greater),  $V_{EN} = V_{IN}$ ,  $I_{OUT} = 1\text{mA}$ ,  $C_{IN} = 2.2\mu\text{F}$ ,  $C_{OUT} = 2.2\mu\text{F}$ ,  $C_{NR/SS} = 0\text{nF}$ , and the FB pin tied to OUT, unless otherwise noted.

PARAMETER		TEST CONDITIONS	TPS7A49xx			UNIT
			MIN	TYP	MAX	
$V_{IN}$	Input voltage range		3.0		35	V
$V_{REF}$	Internal reference	$T_J = +25^\circ\text{C}$ , $V_{NR/SS} = V_{REF}$	1.176	1.194	1.212	V
$V_{OUT}$	Output voltage range <sup>(1)</sup>	$V_{IN} \geq V_{OUT(NOM)} + 1.0\text{V}$	$V_{REF}$		33.0	V
	Nominal accuracy	$T_J = +25^\circ\text{C}$ , $V_{IN} = V_{OUT(NOM)} + 0.5\text{V}$	-1.5		+1.5	% $V_{OUT}$
	Overall accuracy	$V_{OUT(NOM)} + 1.0\text{V} \leq V_{IN} \leq 35\text{V}$ $1\text{mA} \leq I_{OUT} \leq 150\text{mA}$	-2.5		+2.5	% $V_{OUT}$
$\frac{\Delta V_{OUT}(\Delta V_{IN})}{V_{OUT(NOM)}}$	Line regulation	$T_J = +25^\circ\text{C}$ , $V_{OUT(NOM)} + 1.0\text{V} \leq V_{IN} \leq 35\text{V}$		0.11		% $V_{OUT}$
$\frac{\Delta V_{OUT}(\Delta I_{OUT})}{V_{OUT(NOM)}}$	Load regulation	$T_J = +25^\circ\text{C}$ , $1\text{mA} \leq I_{OUT} \leq 150\text{mA}$		0.04		% $V_{OUT}$
$V_{DO}$	Dropout voltage	$V_{IN} = 95\% V_{OUT(NOM)}$ , $I_{OUT} = 100\text{mA}$		260		mV
		$V_{IN} = 95\% V_{OUT(NOM)}$ , $I_{OUT} = 150\text{mA}$		333	600	mV
$I_{LIM}$	Current limit	$V_{OUT} = 90\% V_{OUT(NOM)}$	220	309	500	mA
$I_{GND}$	Ground current	$I_{OUT} = 0\text{mA}$		61	100	$\mu\text{A}$
		$I_{OUT} = 100\text{mA}$		800		$\mu\text{A}$
$I_{SHDN}$	Shutdown supply current	$V_{EN} = +0.4\text{V}$		0.8	3.0	$\mu\text{A}$
$I_{FB}$	Feedback current <sup>(2)</sup>			3	100	nA
$I_{EN}$	Enable current	$V_{EN} = V_{IN} = V_{OUT(NOM)} + 1.0\text{V}$		0.02	1.0	$\mu\text{A}$
		$V_{EN} = V_{IN} = +35\text{V}$		0.2	1.0	$\mu\text{A}$
$V_{EN\_HI}$	Enable high-level voltage		+2.1		$V_{IN}$	V
$V_{EN\_LO}$	Enable low-level voltage		0		+0.4	V
$V_{NOISE}$	Output noise voltage	$V_{IN} = +3\text{V}$ , $V_{OUT(NOM)} = V_{REF}$ , $C_{OUT} = 10\mu\text{F}$ , $C_{NR/SS} = 10\text{nF}$ , BW = 10Hz to 100kHz		15.4		$\mu\text{V}_{RMS}$
		$V_{IN} = +6.2\text{V}$ , $V_{OUT(NOM)} = +5\text{V}$ , $C_{OUT} = 10\mu\text{F}$ , $C_{NR/SS} = C_{BYP}^{(3)} = 10\text{nF}$ , BW = 10Hz to 100kHz		21.15		$\mu\text{V}_{RMS}$
PSRR	Power-supply rejection ratio	$V_{IN} = +6.2\text{V}$ , $V_{OUT(NOM)} = +5\text{V}$ , $C_{OUT} = 10\mu\text{F}$ , $C_{NR/SS} = C_{BYP}^{(3)} = 10\text{nF}$ , $f = 120\text{Hz}$		72		dB
$T_{SD}$	Thermal shutdown temperature	Shutdown, temperature increasing		+170		$^\circ\text{C}$
		Reset, temperature decreasing		+150		$^\circ\text{C}$
$T_J$	Operating junction temperature range		-40		+125	$^\circ\text{C}$

(1) To ensure stability at no load conditions, a current from the feedback resistive network equal to or greater than  $5\mu\text{A}$  is required.

(2)  $I_{FB} > 0$  flows out of the device.

(3)  $C_{BYP}$  refers to a bypass capacitor connected to the FB and OUT pins.

DEVICE INFORMATION

FUNCTIONAL BLOCK DIAGRAM

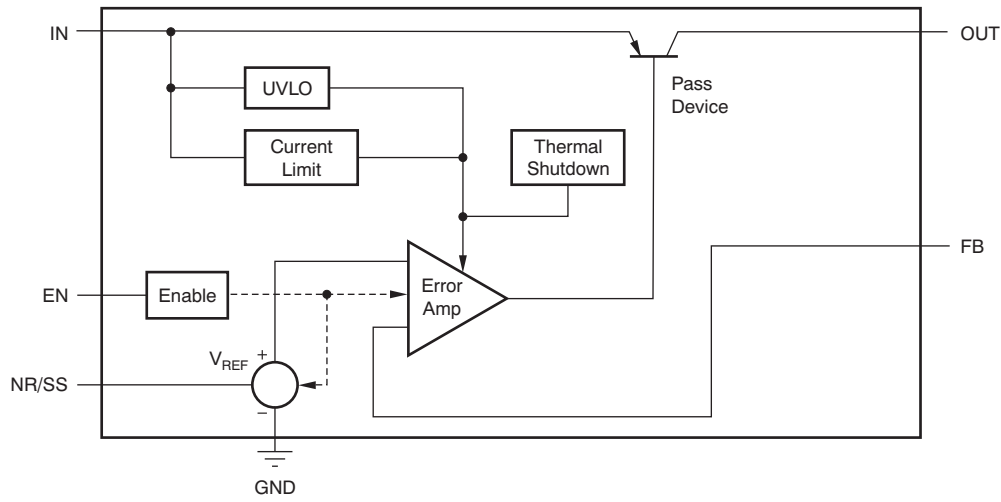

TYPICAL APPLICATION CIRCUIT

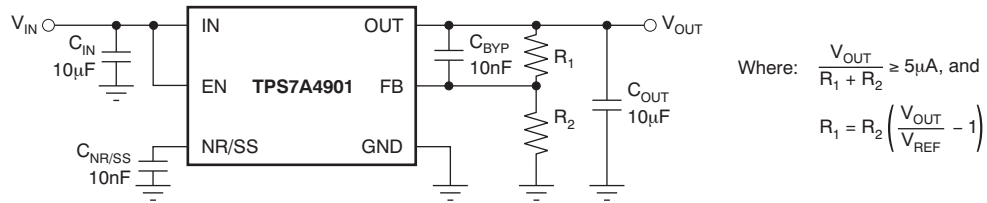

Maximize PSRR Performance and Minimize RMS Noise

## PIN CONFIGURATION

### DGN PACKAGE MSOP-8 (TOP VIEW)

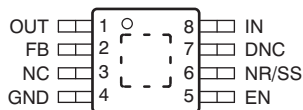

## PIN DESCRIPTIONS

TPS7A49xx		DESCRIPTION
NAME	NO.	
OUT	1	Regulator output. A capacitor $\geq 2.2\mu\text{F}$ must be tied from this pin to ground to assure stability.
FB	2	This pin is the input to the control-loop error amplifier. It is used to set the output voltage of the device.
NC	3	Not internally connected. This pin may either be left open or tied to GND.
GND	4	Ground
EN	5	This pin turns the regulator on or off. If $V_{\text{EN}} \geq V_{\text{EN\_HI}}$ , the regulator is enabled. If $V_{\text{EN\_LO}} \geq V_{\text{EN}}$ , the regulator is disabled. The EN pin can be connected to IN, if not used. $V_{\text{EN}} \leq V_{\text{IN}}$ .
NR/SS	6	Noise reduction pin. Connecting an external capacitor to this pin bypasses noise generated by the internal bandgap. This capacitor allows RMS noise to be reduced to very low levels and also controls the soft-start function.
DNC	7	<b>DO NOT CONNECT.</b> Do not route this pin to any electrical net, not even GND or IN.
IN	8	Input supply
PowerPAD		Must either be left open or tied to ground. Solder to printed circuit board (PCB) plane to enhance thermal performance.

**TYPICAL CHARACTERISTICS**

At  $T_J = -40^{\circ}\text{C}$  to  $+125^{\circ}\text{C}$ ,  $V_{IN} = V_{OUT(NOM)} + 1.0\text{V}$  or  $V_{IN} = 3.0\text{V}$  (whichever is greater),  $V_{EN} = V_{IN}$ ,  $I_{OUT} = 1\text{mA}$ ,  $C_{IN} = 2.2\mu\text{F}$ ,  $C_{OUT} = 2.2\mu\text{F}$ ,  $C_{NR/SS} = 0\text{nF}$ , and the FB pin tied to OUT, unless otherwise noted.

**FEEDBACK VOLTAGE vs INPUT VOLTAGE**

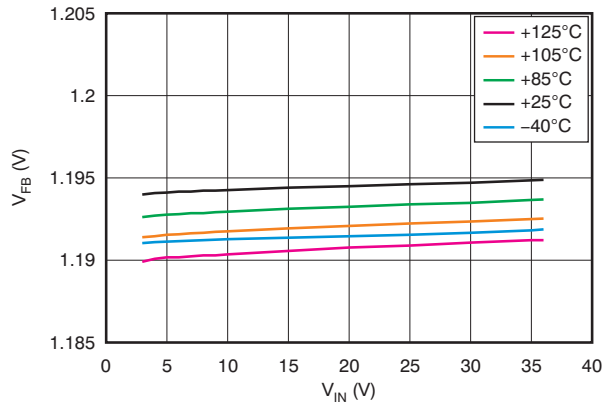

**Figure 1.**

**FEEDBACK CURRENT vs TEMPERATURE**

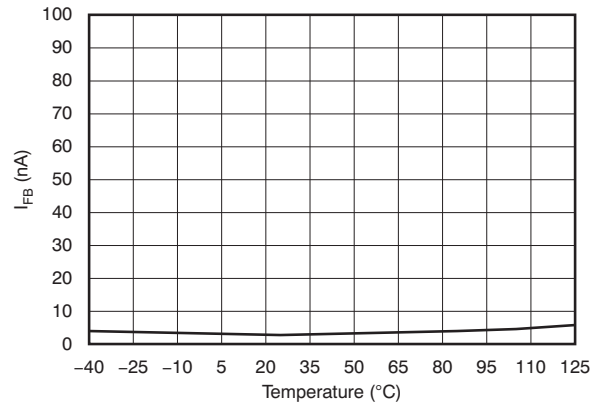

**Figure 2.**

**GROUND CURRENT vs INPUT VOLTAGE**

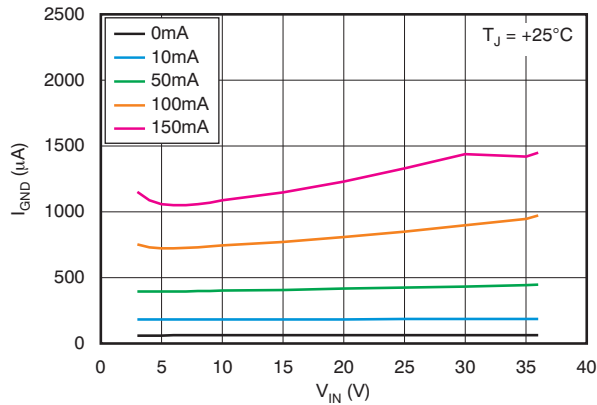

**Figure 3.**

**GROUND CURRENT vs INPUT VOLTAGE**

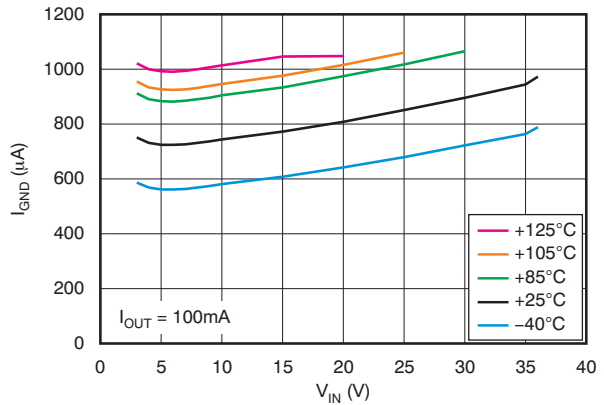

**Figure 4.**

**GROUND CURRENT vs OUTPUT CURRENT**

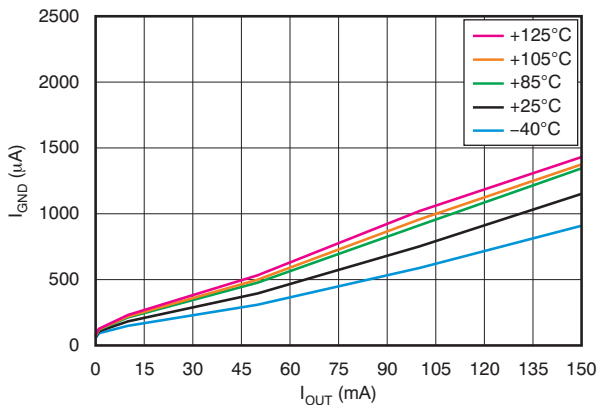

**Figure 5.**

**ENABLE CURRENT vs ENABLE VOLTAGE**

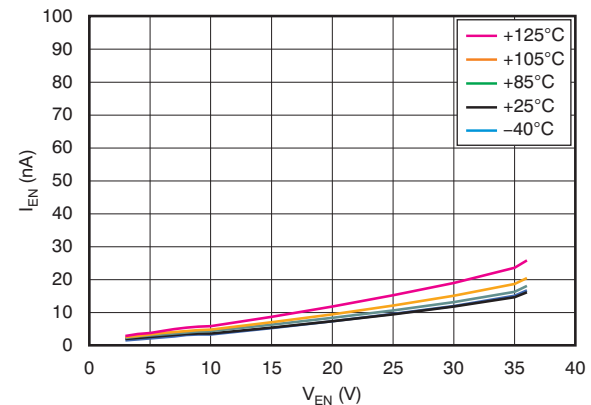
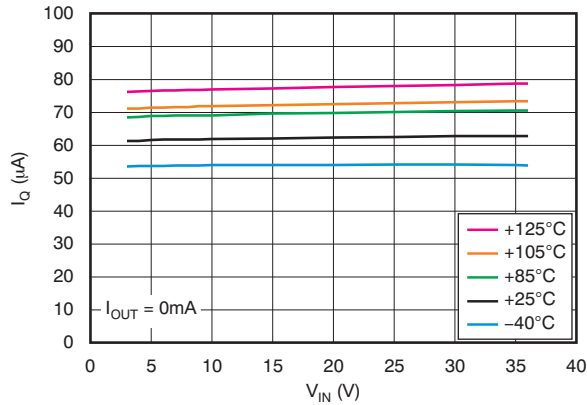

**Figure 6.**

**TYPICAL CHARACTERISTICS (continued)**

At  $T_J = -40^{\circ}\text{C}$  to  $+125^{\circ}\text{C}$ ,  $V_{IN} = V_{OUT(NOM)} + 1.0\text{V}$  or  $V_{IN} = 3.0\text{V}$  (whichever is greater),  $V_{EN} = V_{IN}$ ,  $I_{OUT} = 1\text{mA}$ ,  $C_{IN} = 2.2\mu\text{F}$ ,  $C_{OUT} = 2.2\mu\text{F}$ ,  $C_{NR/SS} = 0\text{nF}$ , and the FB pin tied to OUT, unless otherwise noted.

**QUIESCENT CURRENT vs INPUT VOLTAGE**



**Figure 7.**

**SHUTDOWN CURRENT vs INPUT VOLTAGE**

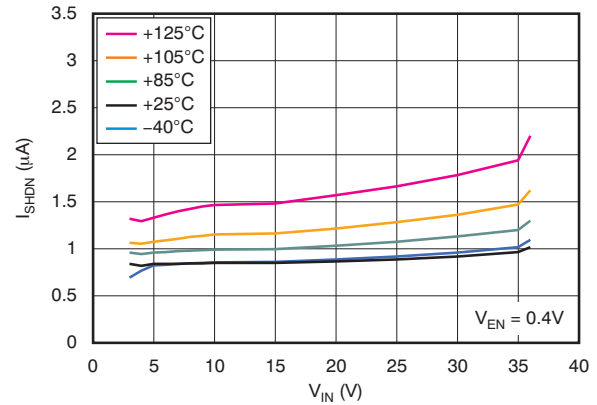

**Figure 8.**

**DROPOUT VOLTAGE vs OUTPUT CURRENT**

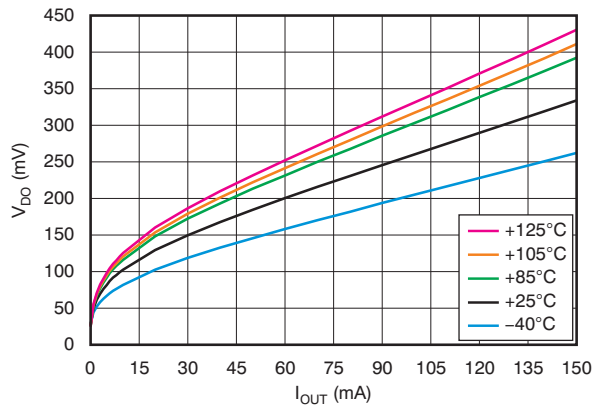

**Figure 9.**

**DROPOUT VOLTAGE vs TEMPERATURE**

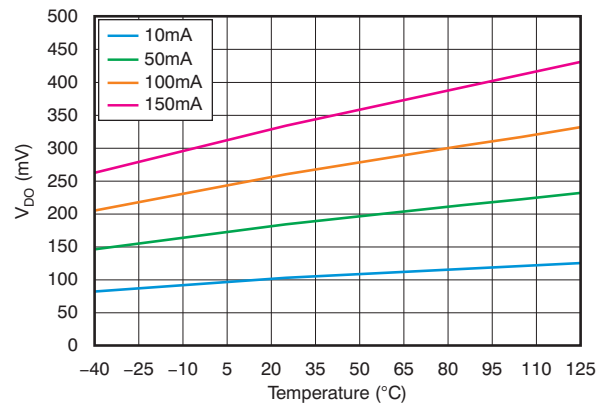

**Figure 10.**

**CURRENT LIMIT vs INPUT VOLTAGE**

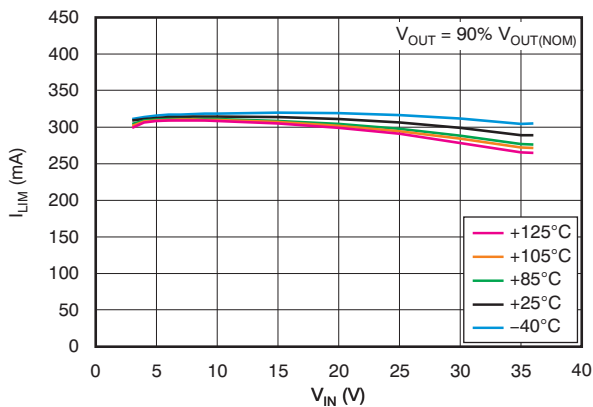

**Figure 11.**

**CURRENT LIMIT vs TEMPERATURE**

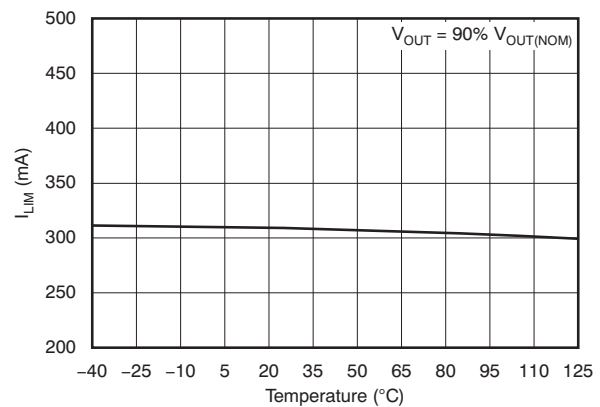

**Figure 12.**

### TYPICAL CHARACTERISTICS (continued)

At  $T_J = -40^\circ\text{C}$  to  $+125^\circ\text{C}$ ,  $V_{IN} = V_{OUT(NOM)} + 1.0\text{V}$  or  $V_{IN} = 3.0\text{V}$  (whichever is greater),  $V_{EN} = V_{IN}$ ,  $I_{OUT} = 1\text{mA}$ ,  $C_{IN} = 2.2\mu\text{F}$ ,  $C_{OUT} = 2.2\mu\text{F}$ ,  $C_{NR/SS} = 0\text{nF}$ , and the FB pin tied to OUT, unless otherwise noted.

**ENABLE THRESHOLD VOLTAGE vs TEMPERATURE**

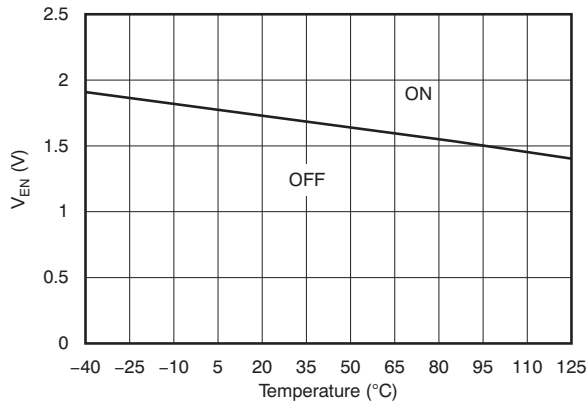

Figure 13.

**POWER-SUPPLY REJECTION RATIO vs C\_OUT**

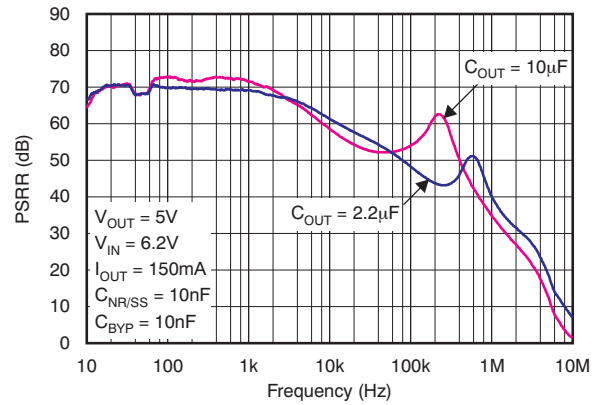

Figure 14.

**LINE REGULATION**

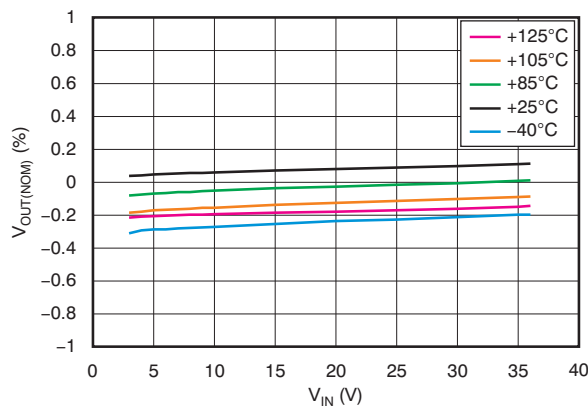

Figure 15.

**POWER-SUPPLY REJECTION RATIO vs C\_NR/SS**

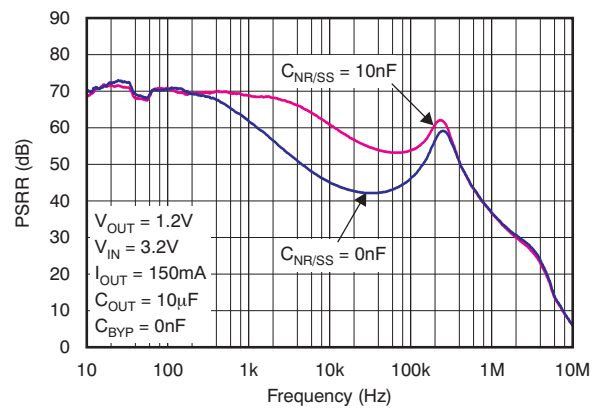

Figure 16.

**LOAD REGULATION**

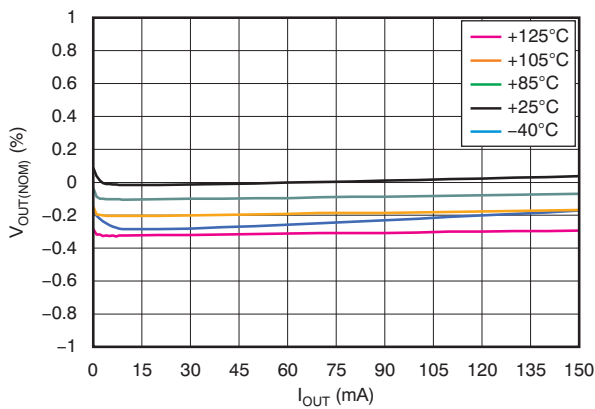

Figure 17.

**POWER-SUPPLY REJECTION RATIO vs C\_BYP**

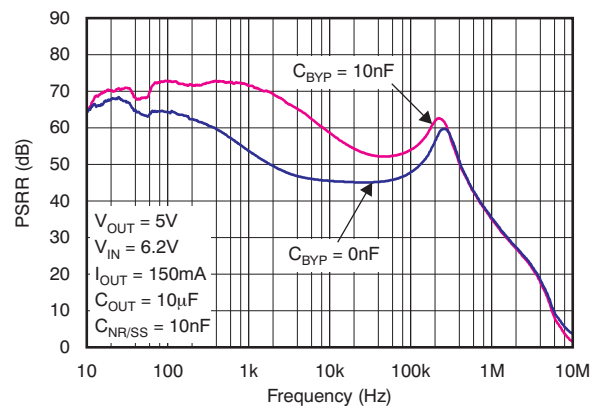

Figure 18.



**TYPICAL CHARACTERISTICS (continued)**

At  $T_J = -40^\circ\text{C}$  to  $+125^\circ\text{C}$ ,  $V_{IN} = V_{OUT(NOM)} + 1.0\text{V}$  or  $V_{IN} = 3.0\text{V}$  (whichever is greater),  $V_{EN} = V_{IN}$ ,  $I_{OUT} = 1\text{mA}$ ,  $C_{IN} = 2.2\mu\text{F}$ ,  $C_{OUT} = 2.2\mu\text{F}$ ,  $C_{NR/SS} = 0\text{nF}$ , and the FB pin tied to OUT, unless otherwise noted.

**OUTPUT SPECTRAL NOISE DENSITY vs OUTPUT CURRENT**

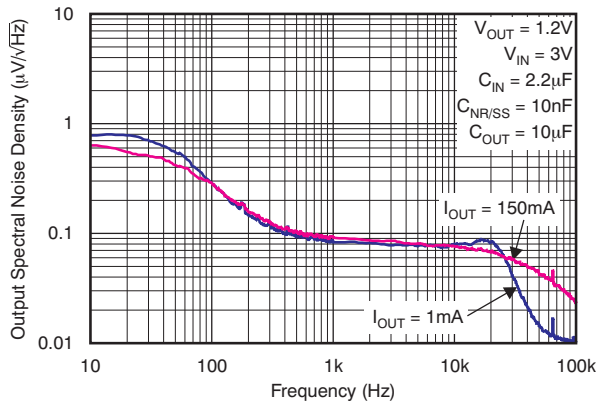

$I_{OUT}$	RMS NOISE	
	10Hz to 100kHz	100Hz to 100kHz
1mA	15.44	14.14
150mA	17.27	16.46

Figure 19.

**OUTPUT SPECTRAL NOISE DENSITY vs  $C_{NR/SS}$**

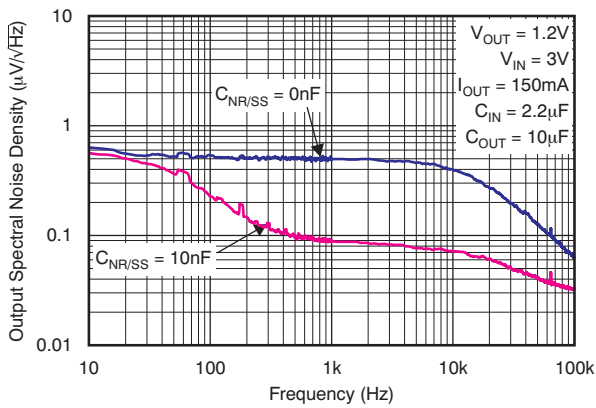

$C_{NR/SS}$	RMS NOISE	
	10Hz to 100kHz	100Hz to 100kHz
0nF	69.04	67.87
10nF	16.58	15.86

Figure 20.

**OUTPUT SPECTRAL NOISE DENSITY vs  $V_{OUT(NOM)}$**

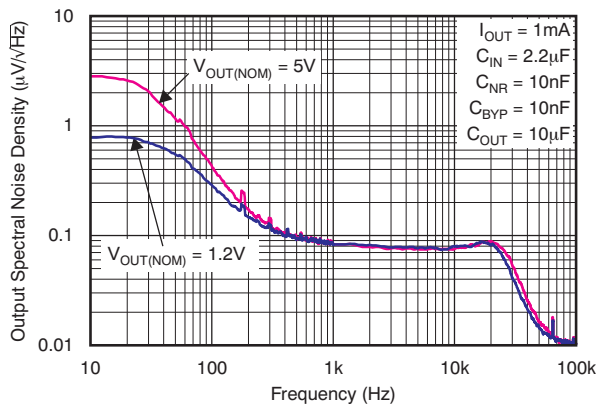

$V_{OUT(NOM)}$	RMS NOISE	
	10Hz to 100kHz	100Hz to 100kHz
5V	21.15	14.74
1.2V	15.44	14.14

Figure 21.

**TYPICAL CHARACTERISTICS (continued)**

At  $T_J = -40^\circ\text{C}$  to  $+125^\circ\text{C}$ ,  $V_{IN} = V_{OUT(NOM)} + 1.0\text{V}$  or  $V_{IN} = 3.0\text{V}$  (whichever is greater),  $V_{EN} = V_{IN}$ ,  $I_{OUT} = 1\text{mA}$ ,  $C_{IN} = 2.2\mu\text{F}$ ,  $C_{OUT} = 2.2\mu\text{F}$ ,  $C_{NR/SS} = 0\text{nF}$ , and the FB pin tied to OUT, unless otherwise noted.

**CAPACITOR-PROGRAMMABLE SOFT-START**

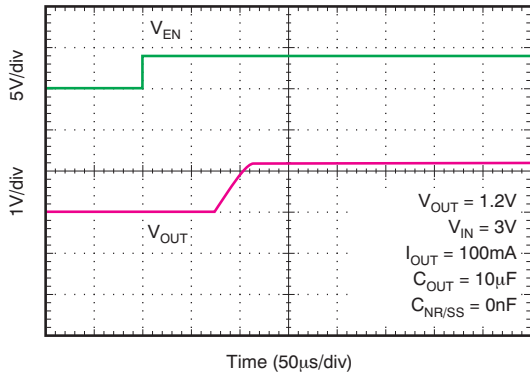

Time (50µs/div)

**Figure 22.**

**CAPACITOR-PROGRAMMABLE SOFT-START**

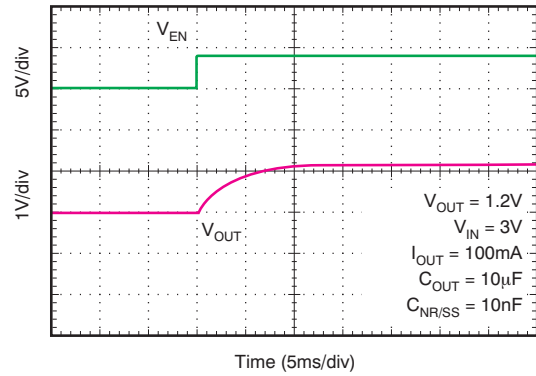

Time (5ms/div)

**Figure 23.**

**LINE TRANSIENT RESPONSE**

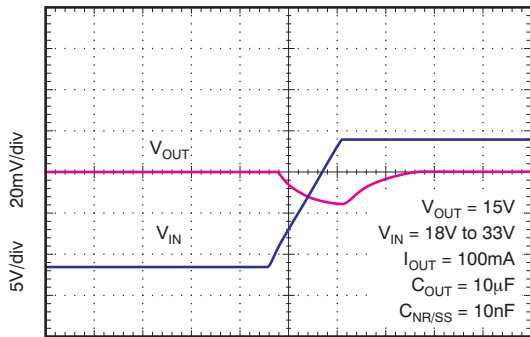

Time (10µs/div)

**Figure 24.**

**LINE TRANSIENT RESPONSE**

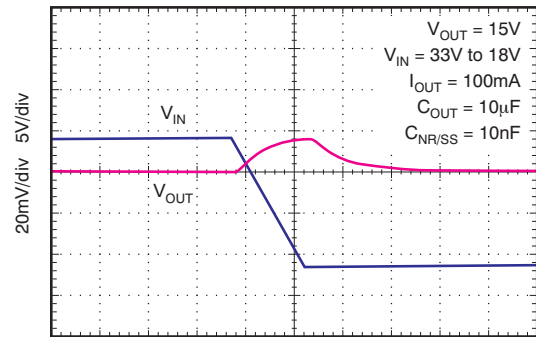

Time (10µs/div)

**Figure 25.**

**LOAD TRANSIENT RESPONSE**

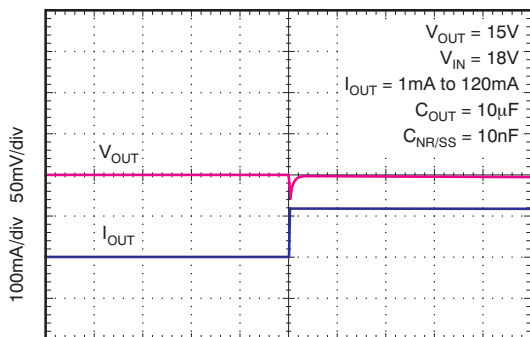

Time (100µs/div)

**Figure 26.**

**LOAD TRANSIENT RESPONSE**

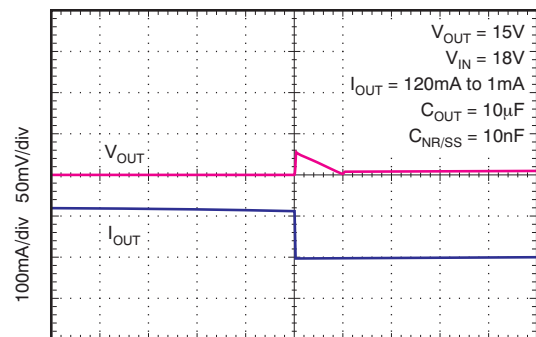

Time (100µs/div)

**Figure 27.**

## THEORY OF OPERATION

### GENERAL DESCRIPTION

The TPS7A49xx belongs to a family of new generation linear regulators that use an innovative bipolar process to achieve ultralow-noise and very high PSRR levels at a wide input voltage range. These features, combined with a high thermal performance MSOP-8 with PowerPAD package make this device ideal for high-performance analog applications.

### ADJUSTABLE OPERATION

The TPS7A4901 has an output voltage range of +1.194 to +33V. The nominal output voltage of the device is set by two external resistors, as shown in [Figure 28](#).

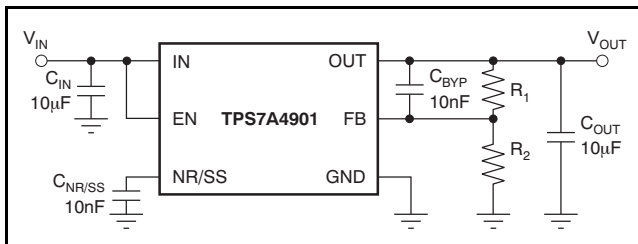

**Figure 28. Adjustable Operation for Maximum AC Performance**

$R_1$  and  $R_2$  can be calculated for any output voltage range using the formula shown in [Equation 1](#). To ensure stability under no load conditions, this resistive network must provide a current equal to or greater than  $5\mu\text{A}$ .

$$R_1 = R_2 \left( \frac{V_{\text{OUT}}}{V_{\text{REF}}} - 1 \right), \quad \text{where } \frac{V_{\text{OUT}}}{R_1 + R_2} \geq 5\mu\text{A} \quad (1)$$

If greater voltage accuracy is required, take into account the output voltage offset contributions because of the feedback pin current and use 0.1% tolerance resistors.

### ENABLE PIN OPERATION

The TPS7A49xx provides an enable feature (EN) that turns on the regulator when  $V_{\text{EN}} > 2.1\text{V}$ .

### CAPACITOR RECOMMENDATIONS

Low ESR capacitors should be used for the input, output, noise reduction, and bypass capacitors. Ceramic capacitors with X7R and X5R dielectrics are preferred. These dielectrics offer more stable characteristics. Ceramic X7R capacitors offer improved over-temperature performance, while ceramic X5R capacitors are the most cost-effective and are available in higher values.

Note that high ESR capacitors may degrade PSRR. To ensure stability, maximum ESR must be less than  $200\text{m}\Omega$ .

### INPUT AND OUTPUT CAPACITOR REQUIREMENTS

The TPS7A49xx family of positive, high-voltage linear regulators achieve stability with a minimum input and output capacitance of  $2.2\mu\text{F}$ ; however, it is highly recommended to use a  $10\mu\text{F}$  capacitor to maximize ac performance.

### NOISE REDUCTION AND BYPASS CAPACITOR REQUIREMENTS

Although noise reduction and bypass capacitors ( $C_{\text{NR/SS}}$  and  $C_{\text{BYP}}$ , respectively) are not needed to achieve stability, it is highly recommended to use  $0.01\mu\text{F}$  capacitors to minimize noise and maximize ac performance.

### MAXIMUM AC PERFORMANCE

In order to maximize noise and PSRR performance, it is recommended to include  $10\mu\text{F}$  or higher input and output capacitors, and  $0.01\mu\text{F}$  noise reduction and bypass capacitors, as shown in [Figure 28](#). The solution shown delivers minimum noise levels of  $15.4\mu\text{V}_{\text{RMS}}$  and power-supply rejection levels above 52dB from 10Hz to 400kHz; see [Figure 18](#) and [Figure 19](#).

## OUTPUT NOISE

The TPS7A49xx provides low output noise when a noise reduction capacitor ( $C_{NR/SS}$ ) is used.

The noise reduction capacitor serves as a filter for the internal reference. By using a 0.01 $\mu$ F noise reduction capacitor, the output noise is reduced by almost 75% (from 69 $\mu$ V<sub>RMS</sub> to 17 $\mu$ V<sub>RMS</sub>); see [Figure 20](#).

TPS7A49xx low output voltage noise makes it an ideal solution for powering noise-sensitive circuitry.

## POWER-SUPPLY REJECTION

The 0.01 $\mu$ F noise reduction capacitor greatly improves TPS7A49xx power-supply rejection, achieving up to 15dB of additional power-supply rejection for frequencies between 110Hz and 200KHz.

Additionally, ac performance can be maximized by adding a 0.01 $\mu$ F bypass capacitor ( $C_{BYP}$ ) from the FB pin to the OUT pin. This capacitor greatly improves power-supply rejection at lower frequencies, for the band from 10Hz to 200kHz; see [Figure 18](#).

The very high power-supply rejection of the TPS7A49xx makes it a good choice for powering high-performance analog circuitry, such as operational amplifiers, ADCs, DACs, and audio amplifiers.

## TRANSIENT RESPONSE

As with any regulator, increasing the size of the output capacitor reduces over/undershoot magnitude but increases duration of the transient response.

## APPLICATION INFORMATION

### POWER FOR PRECISION ANALOG

One of the primary TPS7A49xx applications is to provide ultralow-noise voltage rails to high-performance analog circuitry in order to maximize system accuracy and precision.

The TPS7A49xx family of positive high-voltage linear regulators in conjunction with its negative counterpart (the TPS7A30xx family of negative high-voltage linear regulators), provide ultralow-noise, positive and negative voltage rails for high-performance analog circuitry, such as operational amplifiers, ADCs, DACs, and audio amplifiers.

Because of the ultralow noise levels at high voltages, analog circuitry with high-voltage input supplies can be used. This characteristic allows for high-performance analog solutions to optimize the voltage range, maximizing system accuracy.

### POST DC/DC CONVERTER FILTERING

Most of the time, the voltage rails available in a system do not match the voltage specifications demanded by one or more of its circuits; these rails must be stepped up or down, depending on specific voltage requirements.

DC/DC converters are the preferred solution to step up or down a voltage rail when current consumption is not negligible. They offer high efficiency with minimum heat generation, but they have one primary disadvantage: they introduce a high-frequency component, and the associated harmonics, on top of the dc output signal.

This high-frequency component, if not filtered properly, degrades analog circuitry performance, reducing overall system accuracy and precision.

The TPS7A49xx offers a wide-bandwidth, very-high power-supply rejection ratio. This specification makes it ideal for post dc/dc converter filtering, as shown in Figure 29. It is highly recommended to use the maximum performance schematic shown in Figure 28. Also, verify that the fundamental frequency (and its first harmonic, if possible) is within the bandwidth of the regulator PSRR, shown in Figure 18.

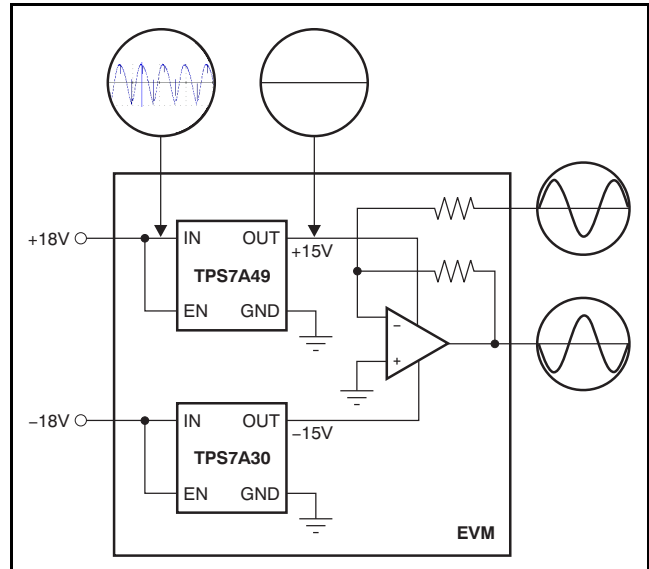

**Figure 29. Post DC/DC Converter Regulation to High-Performance Analog Circuitry**

### AUDIO APPLICATIONS

Audio applications are extremely sensitive to any distortion and noise in the audio band from 20Hz to 20kHz. This stringent requirement demands clean voltage rails to power critical high-performance audio systems.

The very-high power-supply rejection ratio (> 55dB) and low noise at the audio band of the TPS7A49xx maximize performance for audio applications; see Figure 18.

## LAYOUT

### PACKAGE MOUNTING

Solder pad footprint recommendations for the TPS7A49xx are available at the end of this product datasheet and at [www.ti.com](http://www.ti.com).

### BOARD LAYOUT RECOMMENDATIONS TO IMPROVE PSRR AND NOISE PERFORMANCE

To improve ac performance such as PSRR, output noise, and transient response, it is recommended that the board be designed with separate ground planes for IN and OUT, with each ground plane connected only at the GND pin of the device. In addition, the ground connection for the output capacitor should connect directly to the GND pin of the device.

Equivalent series inductance (ESL) and equivalent series resistance (ESR) must be minimized to maximize performance and ensure stability. Every capacitor ( $C_{IN}$ ,  $C_{OUT}$ ,  $C_{NR/SS}$ ,  $C_{BYP}$ ) must be placed as close as possible to the device and on the same side of the printed circuit board (PCB) as the regulator itself.

Do not place any of the capacitors on the opposite side of the PCB from where the regulator is installed. The use of vias and long traces is strongly discouraged because they may impact system performance negatively and even cause instability.

If possible, and to ensure the maximum performance denoted in this product datasheet, use the same layout pattern used for TPS7A49 evaluation board, available at [www.ti.com](http://www.ti.com).

### THERMAL PROTECTION

Thermal protection disables the output when the junction temperature rises to approximately +170°C, allowing the device to cool. When the junction temperature cools to approximately +150°C, the output circuitry is enabled. Depending on power dissipation, thermal resistance, and ambient temperature, the thermal protection circuit may cycle on and off. This cycling limits the dissipation of the regulator, protecting it from damage as a result of overheating.

Any tendency to activate the thermal protection circuit indicates excessive power dissipation or an inadequate heatsink. For reliable operation, junction temperature should be limited to a maximum of +125°C. To estimate the margin of safety in a complete design (including heatsink), increase the ambient temperature until the thermal protection is triggered; use worst-case loads and signal conditions. For good reliability, thermal protection should trigger

at least +35°C above the maximum expected ambient condition of your particular application. This configuration produces a worst-case junction temperature of +125°C at the highest expected ambient temperature and worst-case load.

The internal protection circuitry of the TPS7A49xx has been designed to protect against overload conditions. It was not intended to replace proper heatsinking. Continuously running the TPS7A49xx into thermal shutdown degrades device reliability.

### POWER DISSIPATION

The ability to remove heat from the die is different for each package type, presenting different considerations in the PCB layout. The PCB area around the device that is free of other components moves the heat from the device to the ambient air. Performance data or JEDEC low- and high-K boards are given in the [Dissipation Ratings Table](#). Using heavier copper increases the effectiveness in removing heat from the device. The addition of plated through-holes to heat dissipating layers also improves the heatsink effectiveness.

Power dissipation depends on input voltage and load conditions. Power dissipation ( $P_D$ ) is equal to the product of the output current times the voltage drop across the output pass element, as shown in [Equation 2](#):

$$P_D = (V_{IN} - V_{OUT}) I_{OUT} \quad (2)$$

### SUGGESTED LAYOUT AND SCHEMATIC

Layout is a critical part of good power-supply design. There are several signal paths that conduct fast-changing currents or voltages that can interact with stray inductance or parasitic capacitance to generate noise or degrade the power-supply performance. To help eliminate these problems, the IN pin should be bypassed to ground with a low ESR ceramic bypass capacitor with a X5R or X7R dielectric.

The GND pin should be tied directly to the PowerPAD under the IC. The PowerPAD should be connected to any internal PCB ground planes using multiple vias directly under the IC.

It may be possible to obtain acceptable performance with alternate PCB layouts; however, the layout shown in [Figure 30](#) and the schematic shown in [Figure 31](#) have been shown to produce good results and are meant as a guideline.

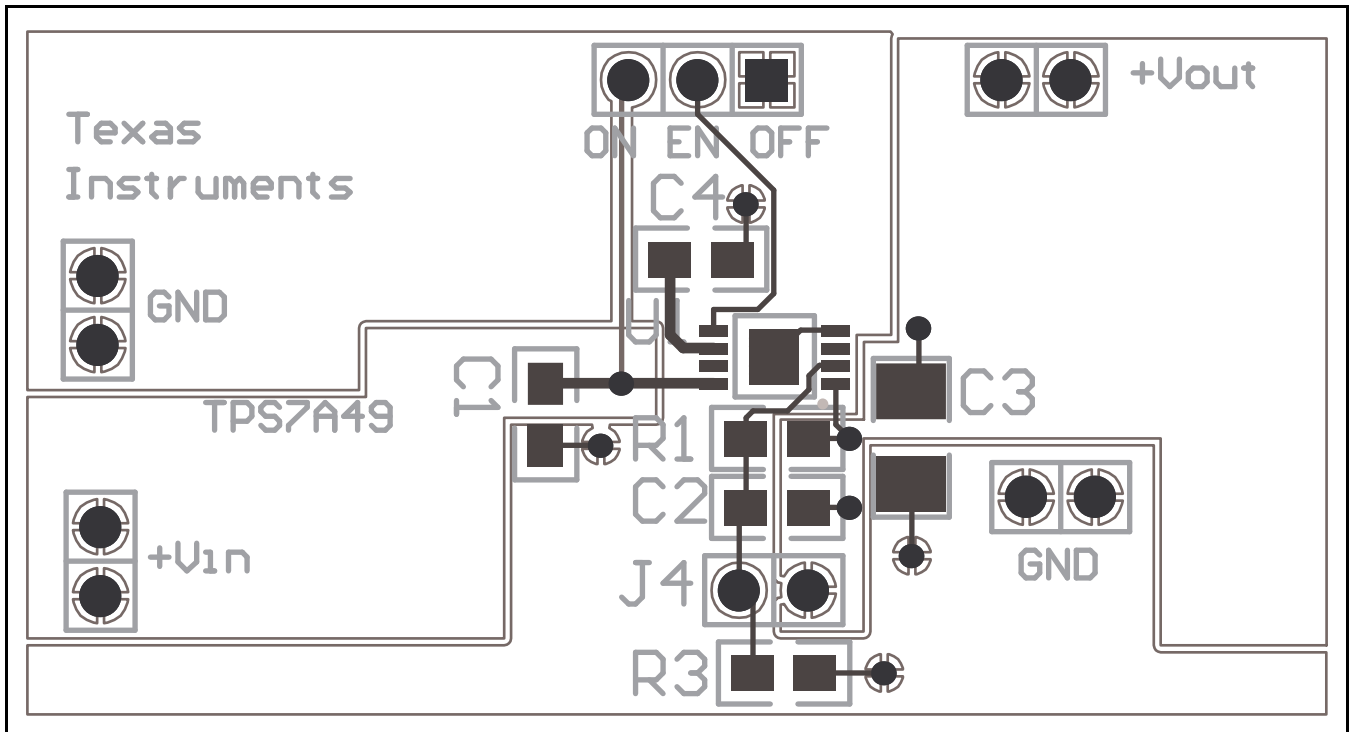

Figure 30. PCB Layout Example

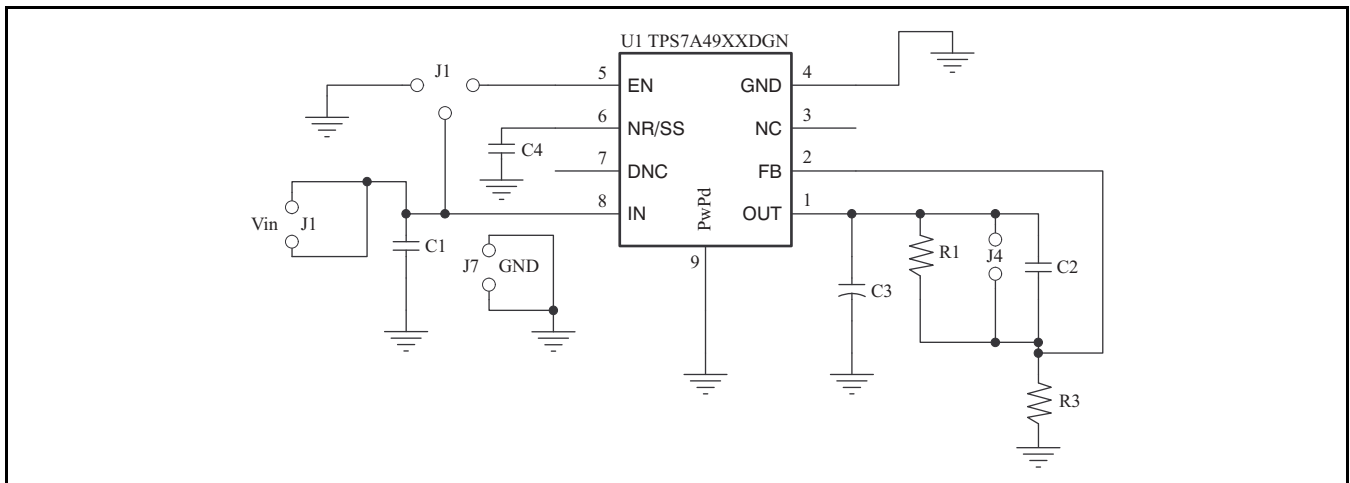

Figure 31. Schematic for PCB Layout Example

## REVISION HISTORY

NOTE: Page numbers for previous revisions may differ from page numbers in the current version.

---

**Changes from Revision A (September 2010) to Revision B** **Page**

- Changed HBM max value from 500V to 1500V ..... **2**
- 

**Changes from Original (August 2010) to Revision A** **Page**

- Revised *Features* list ..... **1**
  - Changed *Description* text (paragraph 1) to remove description of maximum load ..... **1**
  - Revised *shutdown supply current*, *feedback current*, and *enable current* specifications; rounded typical performance values ..... **3**
  - Revised *Functional Block Diagram* for clarification ..... **4**
  - Changed description of NC pin (pin 3) in *Pin Descriptions* table ..... **5**
  - Updated [Figure 1](#) to show correct device performance ..... **6**
-



**PACKAGING INFORMATION**

Orderable Device	Status <sup>(1)</sup>	Package Type	Package Drawing	Pins	Package Qty	Eco Plan <sup>(2)</sup>	Lead/ Ball Finish	MSL Peak Temp <sup>(3)</sup>	Samples (Requires Login)
TPS7A4901DGNR	ACTIVE	MSOP-PowerPAD	DGN	8	2500	Green (RoHS & no Sb/Br)	CU NIPDAU	Level-2-260C-1 YEAR	<a href="#">Request Free Samples</a>
TPS7A4901DGNT	ACTIVE	MSOP-PowerPAD	DGN	8	250	Green (RoHS & no Sb/Br)	CU NIPDAU	Level-2-260C-1 YEAR	<a href="#">Request Free Samples</a>

<sup>(1)</sup> The marketing status values are defined as follows:

**ACTIVE:** Product device recommended for new designs.

**LIFEBUY:** TI has announced that the device will be discontinued, and a lifetime-buy period is in effect.

**NRND:** Not recommended for new designs. Device is in production to support existing customers, but TI does not recommend using this part in a new design.

**PREVIEW:** Device has been announced but is not in production. Samples may or may not be available.

**OBsolete:** TI has discontinued the production of the device.

<sup>(2)</sup> Eco Plan - The planned eco-friendly classification: Pb-Free (RoHS), Pb-Free (RoHS Exempt), or Green (RoHS & no Sb/Br) - please check <http://www.ti.com/productcontent> for the latest availability information and additional product content details.

**TBD:** The Pb-Free/Green conversion plan has not been defined.

**Pb-Free (RoHS):** TI's terms "Lead-Free" or "Pb-Free" mean semiconductor products that are compatible with the current RoHS requirements for all 6 substances, including the requirement that lead not exceed 0.1% by weight in homogeneous materials. Where designed to be soldered at high temperatures, TI Pb-Free products are suitable for use in specified lead-free processes.

**Pb-Free (RoHS Exempt):** This component has a RoHS exemption for either 1) lead-based flip-chip solder bumps used between the die and package, or 2) lead-based die adhesive used between the die and leadframe. The component is otherwise considered Pb-Free (RoHS compatible) as defined above.

**Green (RoHS & no Sb/Br):** TI defines "Green" to mean Pb-Free (RoHS compatible), and free of Bromine (Br) and Antimony (Sb) based flame retardants (Br or Sb do not exceed 0.1% by weight in homogeneous material)

<sup>(3)</sup> MSL, Peak Temp. -- The Moisture Sensitivity Level rating according to the JEDEC industry standard classifications, and peak solder temperature.

**Important Information and Disclaimer:** The information provided on this page represents TI's knowledge and belief as of the date that it is provided. TI bases its knowledge and belief on information provided by third parties, and makes no representation or warranty as to the accuracy of such information. Efforts are underway to better integrate information from third parties. TI has taken and continues to take reasonable steps to provide representative and accurate information but may not have conducted destructive testing or chemical analysis on incoming materials and chemicals. TI and TI suppliers consider certain information to be proprietary, and thus CAS numbers and other limited information may not be available for release.

In no event shall TI's liability arising out of such information exceed the total purchase price of the TI part(s) at issue in this document sold by TI to Customer on an annual basis.

**TAPE AND REEL INFORMATION**
**REEL DIMENSIONS**

**TAPE DIMENSIONS**

A0	Dimension designed to accommodate the component width
B0	Dimension designed to accommodate the component length
K0	Dimension designed to accommodate the component thickness
W	Overall width of the carrier tape
P1	Pitch between successive cavity centers

**TAPE AND REEL INFORMATION**

\*All dimensions are nominal

Device	Package Type	Package Drawing	Pins	SPQ	Reel Diameter (mm)	Reel Width W1 (mm)	A0 (mm)	B0 (mm)	K0 (mm)	P1 (mm)	W (mm)	Pin1 Quadrant
TPS7A4901DGNR	MSOP-Power PAD	DGN	8	2500	330.0	12.4	5.3	3.4	1.4	8.0	12.0	Q1
TPS7A4901DGNT	MSOP-Power PAD	DGN	8	250	180.0	12.4	5.3	3.4	1.4	8.0	12.0	Q1

**TAPE AND REEL BOX DIMENSIONS**

\*All dimensions are nominal

Device	Package Type	Package Drawing	Pins	SPQ	Length (mm)	Width (mm)	Height (mm)
TPS7A4901DGNR	MSOP-PowerPAD	DGN	8	2500	367.0	367.0	35.0
TPS7A4901DGNT	MSOP-PowerPAD	DGN	8	250	210.0	185.0	35.0

DGN (S-PDSO-G8)

PowerPAD™ PLASTIC SMALL OUTLINE



- NOTES:
- All linear dimensions are in millimeters.
  - This drawing is subject to change without notice.
  - Body dimensions do not include mold flash or protrusion.
  - This package is designed to be soldered to a thermal pad on the board. Refer to Technical Brief, PowerPad Thermally Enhanced Package, Texas Instruments Literature No. SLMA002 for information regarding recommended board layout. This document is available at [www.ti.com](http://www.ti.com) <<http://www.ti.com>>.
  - See the additional figure in the Product Data Sheet for details regarding the exposed thermal pad features and dimensions.
  - Falls within JEDEC MO-187 variation AA-T

PowerPAD is a trademark of Texas Instruments.

DGN (S-PDSO-G8)

PowerPAD™ PLASTIC SMALL OUTLINE

## THERMAL INFORMATION

This PowerPAD™ package incorporates an exposed thermal pad that is designed to be attached to a printed circuit board (PCB). The thermal pad must be soldered directly to the PCB. After soldering, the PCB can be used as a heatsink. In addition, through the use of thermal vias, the thermal pad can be attached directly to the appropriate copper plane shown in the electrical schematic for the device, or alternatively, can be attached to a special heatsink structure designed into the PCB. This design optimizes the heat transfer from the integrated circuit (IC).

For additional information on the PowerPAD package and how to take advantage of its heat dissipating abilities, refer to Technical Brief, PowerPAD Thermally Enhanced Package, Texas Instruments Literature No. SLMA002 and Application Brief, PowerPAD Made Easy, Texas Instruments Literature No. SLMA004. Both documents are available at [www.ti.com](http://www.ti.com).

The exposed thermal pad dimensions for this package are shown in the following illustration.

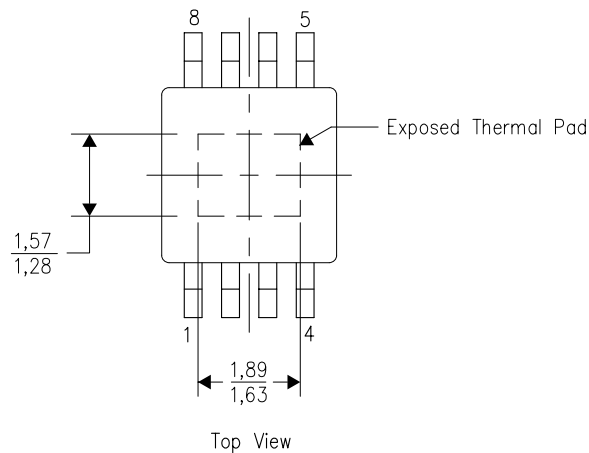

Exposed Thermal Pad Dimensions

4206323-2/1 12/11

NOTE: All linear dimensions are in millimeters

PowerPAD is a trademark of Texas Instruments

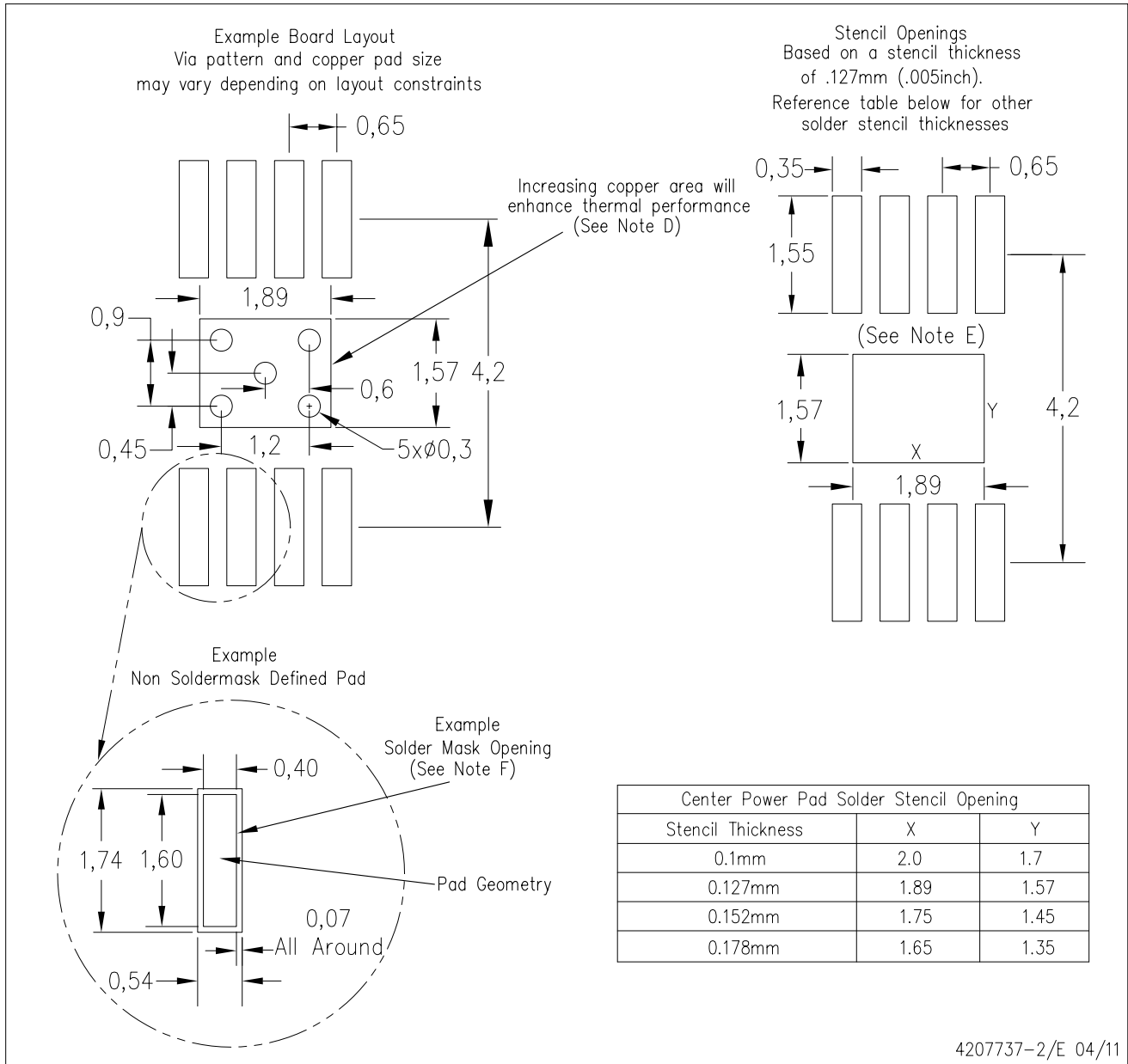

- NOTES:
- A. All linear dimensions are in millimeters.
  - B. This drawing is subject to change without notice.
  - C. Customers should place a note on the circuit board fabrication drawing not to alter the center solder mask defined pad.
  - D. This package is designed to be soldered to a thermal pad on the board. Refer to Technical Brief, PowerPad Thermally Enhanced Package, Texas Instruments Literature No. SLMA002, SLMA004, and also the Product Data Sheets for specific thermal information, via requirements, and recommended board layout. These documents are available at [www.ti.com](http://www.ti.com) <<http://www.ti.com>>. Publication IPC-7351 is recommended for alternate designs.
  - E. Laser cutting apertures with trapezoidal walls and also rounding corners will offer better paste release. Customers should contact their board assembly site for stencil design recommendations. Example stencil design based on a 50% volumetric metal load solder paste. Refer to IPC-7525 for other stencil recommendations.
  - F. Customers should contact their board fabrication site for solder mask tolerances between and around signal pads.

PowerPAD is a trademark of Texas Instruments

## IMPORTANT NOTICE

Texas Instruments Incorporated and its subsidiaries (TI) reserve the right to make corrections, enhancements, improvements and other changes to its semiconductor products and services per JESD46C and to discontinue any product or service per JESD48B. Buyers should obtain the latest relevant information before placing orders and should verify that such information is current and complete. All semiconductor products (also referred to herein as "components") are sold subject to TI's terms and conditions of sale supplied at the time of order acknowledgment.

TI warrants performance of its components to the specifications applicable at the time of sale, in accordance with the warranty in TI's terms and conditions of sale of semiconductor products. Testing and other quality control techniques are used to the extent TI deems necessary to support this warranty. Except where mandated by applicable law, testing of all parameters of each component is not necessarily performed.

TI assumes no liability for applications assistance or the design of Buyers' products. Buyers are responsible for their products and applications using TI components. To minimize the risks associated with Buyers' products and applications, Buyers should provide adequate design and operating safeguards.

TI does not warrant or represent that any license, either express or implied, is granted under any patent right, copyright, mask work right, or other intellectual property right relating to any combination, machine, or process in which TI components or services are used. Information published by TI regarding third-party products or services does not constitute a license to use such products or services or a warranty or endorsement thereof. Use of such information may require a license from a third party under the patents or other intellectual property of the third party, or a license from TI under the patents or other intellectual property of TI.

Reproduction of significant portions of TI information in TI data books or data sheets is permissible only if reproduction is without alteration and is accompanied by all associated warranties, conditions, limitations, and notices. TI is not responsible or liable for such altered documentation. Information of third parties may be subject to additional restrictions.

Resale of TI components or services with statements different from or beyond the parameters stated by TI for that component or service voids all express and any implied warranties for the associated TI component or service and is an unfair and deceptive business practice. TI is not responsible or liable for any such statements.

Buyer acknowledges and agrees that it is solely responsible for compliance with all legal, regulatory and safety-related requirements concerning its products, and any use of TI components in its applications, notwithstanding any applications-related information or support that may be provided by TI. Buyer represents and agrees that it has all the necessary expertise to create and implement safeguards which anticipate dangerous consequences of failures, monitor failures and their consequences, lessen the likelihood of failures that might cause harm and take appropriate remedial actions. Buyer will fully indemnify TI and its representatives against any damages arising out of the use of any TI components in safety-critical applications.

In some cases, TI components may be promoted specifically to facilitate safety-related applications. With such components, TI's goal is to help enable customers to design and create their own end-product solutions that meet applicable functional safety standards and requirements. Nonetheless, such components are subject to these terms.

No TI components are authorized for use in FDA Class III (or similar life-critical medical equipment) unless authorized officers of the parties have executed a special agreement specifically governing such use.

Only those TI components which TI has specifically designated as military grade or "enhanced plastic" are designed and intended for use in military/aerospace applications or environments. Buyer acknowledges and agrees that any military or aerospace use of TI components which have **not** been so designated is solely at the Buyer's risk, and that Buyer is solely responsible for compliance with all legal and regulatory requirements in connection with such use.

TI has specifically designated certain components which meet ISO/TS16949 requirements, mainly for automotive use. Components which have not been so designated are neither designed nor intended for automotive use; and TI will not be responsible for any failure of such components to meet such requirements.

### Products

Audio	<a href="http://www.ti.com/audio">www.ti.com/audio</a>
Amplifiers	<a href="http://amplifier.ti.com">amplifier.ti.com</a>
Data Converters	<a href="http://dataconverter.ti.com">dataconverter.ti.com</a>
DLP® Products	<a href="http://www.dlp.com">www.dlp.com</a>
DSP	<a href="http://dsp.ti.com">dsp.ti.com</a>
Clocks and Timers	<a href="http://www.ti.com/clocks">www.ti.com/clocks</a>
Interface	<a href="http://interface.ti.com">interface.ti.com</a>
Logic	<a href="http://logic.ti.com">logic.ti.com</a>
Power Mgmt	<a href="http://power.ti.com">power.ti.com</a>
Microcontrollers	<a href="http://microcontroller.ti.com">microcontroller.ti.com</a>
RFID	<a href="http://www.ti-rfid.com">www.ti-rfid.com</a>
OMAP Mobile Processors	<a href="http://www.ti.com/omap">www.ti.com/omap</a>
Wireless Connectivity	<a href="http://www.ti.com/wirelessconnectivity">www.ti.com/wirelessconnectivity</a>

### Applications

Automotive and Transportation	<a href="http://www.ti.com/automotive">www.ti.com/automotive</a>
Communications and Telecom	<a href="http://www.ti.com/communications">www.ti.com/communications</a>
Computers and Peripherals	<a href="http://www.ti.com/computers">www.ti.com/computers</a>
Consumer Electronics	<a href="http://www.ti.com/consumer-apps">www.ti.com/consumer-apps</a>
Energy and Lighting	<a href="http://www.ti.com/energy">www.ti.com/energy</a>
Industrial	<a href="http://www.ti.com/industrial">www.ti.com/industrial</a>
Medical	<a href="http://www.ti.com/medical">www.ti.com/medical</a>
Security	<a href="http://www.ti.com/security">www.ti.com/security</a>
Space, Avionics and Defense	<a href="http://www.ti.com/space-avionics-defense">www.ti.com/space-avionics-defense</a>
Video and Imaging	<a href="http://www.ti.com/video">www.ti.com/video</a>

**TI E2E Community** [e2e.ti.com](http://e2e.ti.com)