

Sub-Miniature Rocker Switch SMRS-102-1

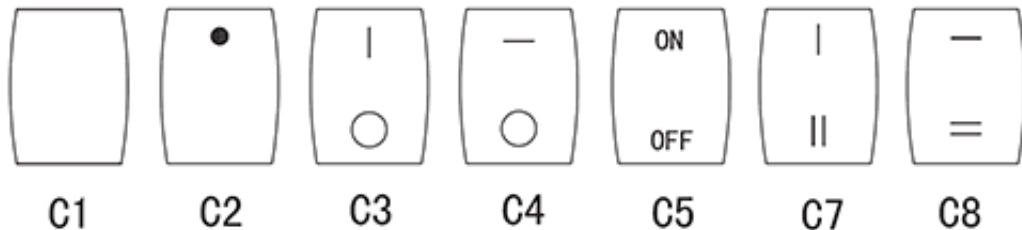

Specification

1. Product Name : SMRS-102-1
2. Rating : 3A 125VAC ; 1A 250VAC
3. Contact Resistance:35mΩ max
4. Insulation Resistance:500VDC 100MΩ min
5. Dielectric Strength:1500VAC 1Minute
6. Operating Temperature:-25°C~+85°C
7. Electrical Life:10000 Cycles
8. Cap marking:



9. Cap color:Black、 White、 Red、 Yellow、 Green、 Blue、 Orange、 Gray
10. Circuitry trait:ON-OFF
11. Certification system : TUV、 UL、 IOS9001:2015、 CE、 ENECandOther

Product details and dimensions

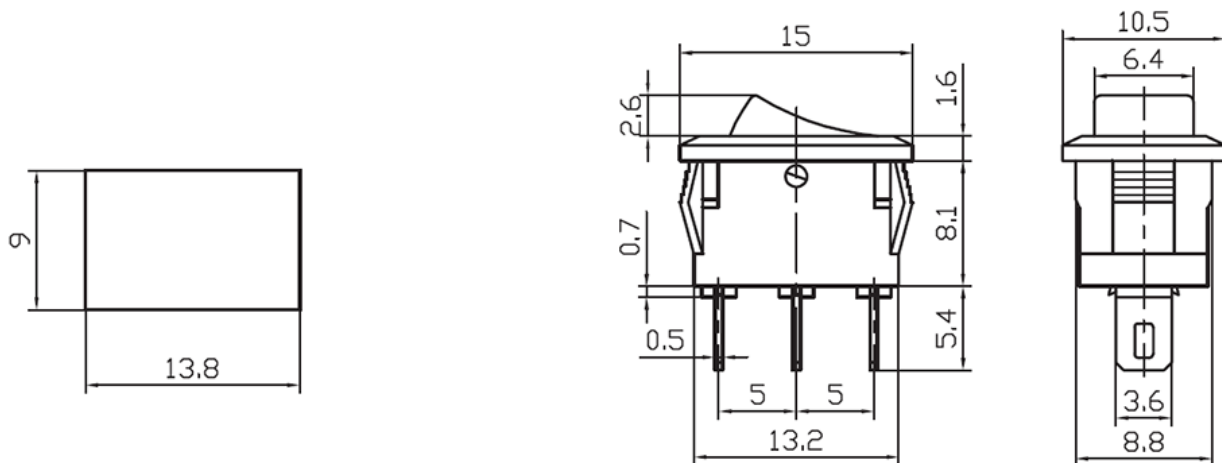

Company profile

Ningbo Jietong Electronic is found in Ningbo, China. April,1994 and is specialized in providing excellent purductions and services to both domestic and overseas electrical clients.

The factory is located in Ningbo. Our products cover: rocker switch, toggle switch, push button switch and automobile switch.

We focus on providing qualified and reliable switches, cooperating closelywith our clients world wide, from where we accumulate precious experience bya variety of transactions. Yearly output is around 50 million.

We have been strictly implementing ISO 9001:2008 regulations in the whole production process. As a result, our products are compliant with RoHS standards and carry UL, , TuV, ENEC, CE, and KEMA,safety approvals

Jietong Electronic prides itself on providing the widest and broadest range of quality branded products at an afordable price. Backed by Jieong Electronic renowned professional service andtechnical support, customers can be sure that their product requirements will be satisfedwhatever the request. All customers receive a frst class service whatever the size of their orderhelping them to run their business more efciently.

--	--	--

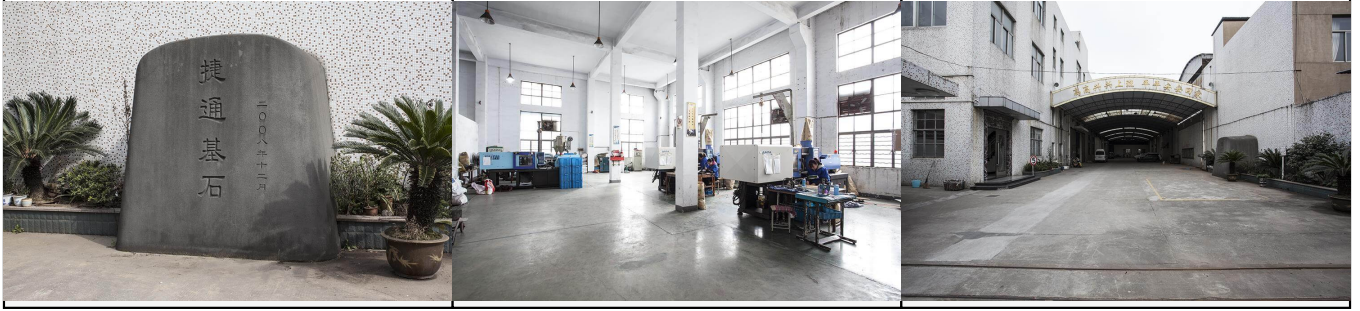

Product link : <https://www.jietongswitch.com/sub-miniature-rocker-switch-smrs-102-1-products/>