

Push Button Switch PBS-12A

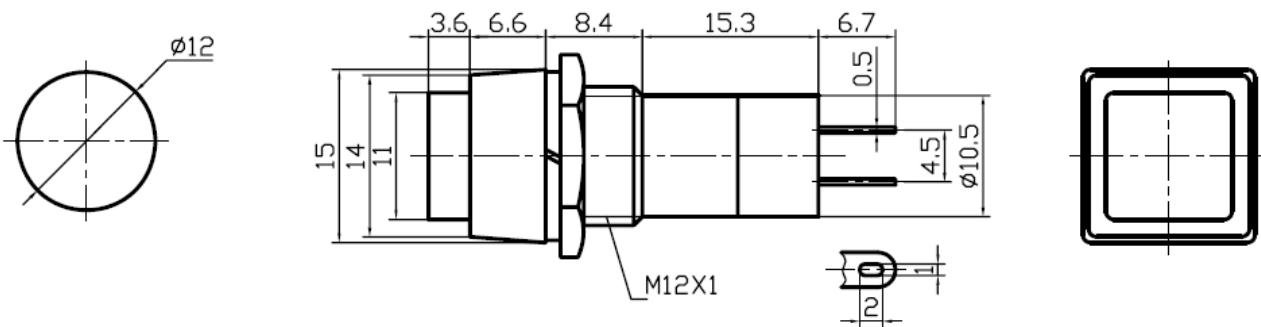

Specification

1. Product Name : PBS-12A,PBS-12B,PBS-12C
2. Rating : 3A 125VAC ; 1A 250VAC
3. Contact Resistance:20mΩ max
4. Insulation Resistance:500VDC 100MΩ min
5. Dielectric Strength:1000VAC 1Minute
6. Operating Temperature:-25°C~+85°C
7. Electrical Life:50000 Cycles
8. Push-button color:Red、 White、 Green、 Black、 Orange、 Yellow、 Blue
9. Circuitry trait:ON-OFF,OFF-(ON),ON-(OFF) ()Indicates Momentary
10. Certification system : TUV、 UL、 IOS9001:2015、 CE、 ENECandOther

Product details and dimensions



Company profile

Ningbo Jietong Electronic is found in Ningbo, China. April,1994 and is specialized in providing excellent purductions and services to both domestic and overseas electrical clients.

The factory is located in Ningbo. Our products cover: rocker switch, toggle switch, push button switch and automobile switch.

We focus on providing qualified and reliable switches, cooperating closelywith our clients world wide, from where we accumulate precious experience bya variety of transactions. Yearly output is around 50 million.

We have been strictly implementing ISO 9001:2008 regulations in the whole production process. As a result, our products are compliant with RoHS standards and carry UL, , TuV, ENEC, CE, and KEMA,safety approvals

Jietong Electronic prides itself on providing the widest and broadest range of quality branded products at an affordable price. Backed by Jieong Electronic renowned professional service and technical support, customers can be sure that their product requirements will be satisfied whatever the request. All customers receive a first class service whatever the size of their order helping them to run their business more efficiently.

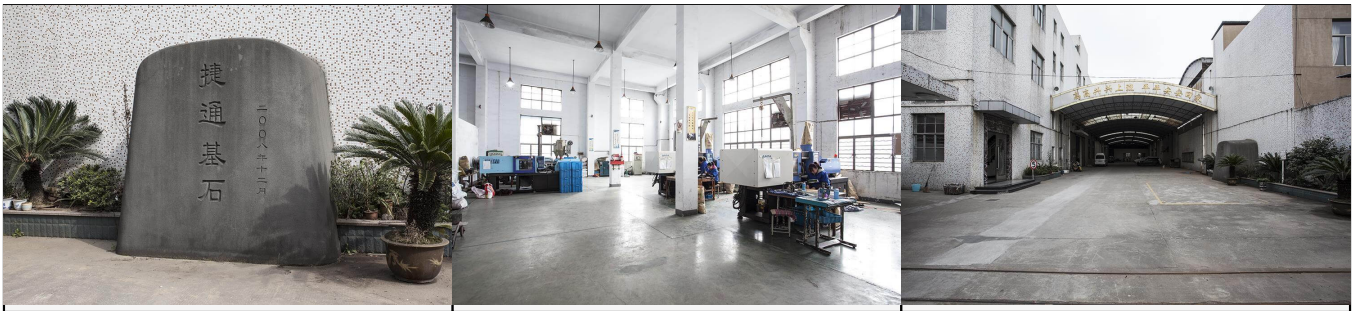

Product link : <https://www.jietongswitch.com/push-button-switch-pbs-12a-products/>