

REV.	DESCRIPTION	DRAWN	CHECKED	APPROVED
A	NEW RELEASE	YCH 12/13/08	~	

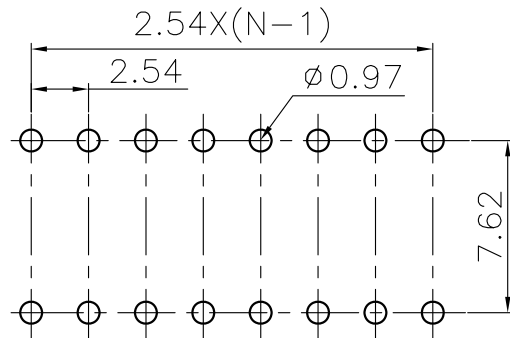
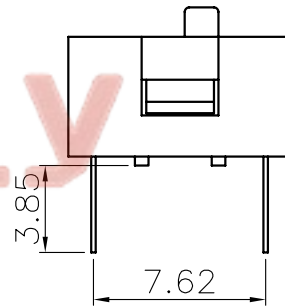
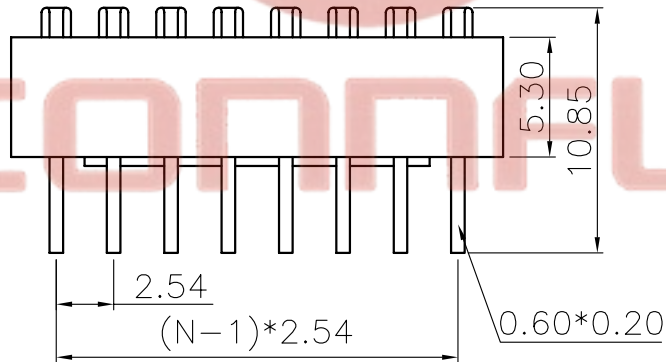
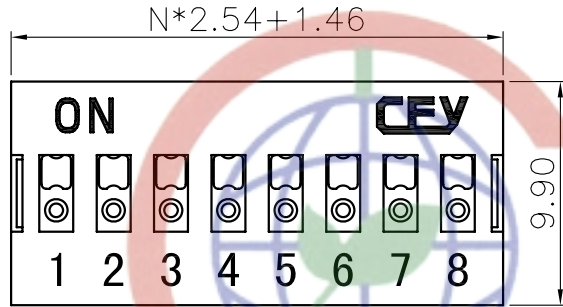

RECOMMEND PCB LAYOUT
(TOLERANCE=±0.05)

NOTES:

- 1.MECHANICAL
 - 1.1 Operation Force: 800g Max
 - 1.2 Stroke: 1.90mm
 - 1.3 Operation Temperature: -25°C~+80°C
 - 1.4 Storage Temperature: -45°C~+90°C
- 2.MATERIALS
 - 2.1 Base: Engineering Plastics,Black
 - 2.2 Cover: Engineering Plastics,Red or Blue
 - 2.3 Button: Engineering Plastics,White
 - 2.4 Terminal: Alloy Copper, Gold plating
- 3.ELECTRICAL
 - 3.1 Electrical Life: 2000 operations cycles per switch
 - 3.2 Non-Switching Rating: 100mA,50VDC
 - 3.3 Switching rating: 25mA,24VDC
 - 3.4 Contact resistance: 50mΩ Max. at initial; 100mΩ Max. after life test.
 - 3.5 Insulation Resistance: 100MΩ,500VDC
 - 3.6 Dielectric Strength: 500VAC/1 minute
 - 3.7 Circuit: Single pole single throw
4. PRODUCT NUMBER CODE:

DS1040 - X X X
 X Housing Type
 N: Regular
 X Housing color
 R: Red
 B: Blue
 K: Black
 N: Brown
 X Positions

- 01: 1pin 07: 7pin
- 02: 2pin 08: 8pin
- 03: 3pin 09: 9pin
- 04: 4pin 10: 10pin
- 05: 5pin 11: 11pin
- 06: 6pin 12: 12pin

GENERAL TOLERANCE		ANGLE TOLERANCE		PROJECTION	TITLE
X.	±0.60	X.	±5°	mm	DIP SWITCH
.X	±0.38	.X	±3°		
.XX	±0.25	.XX	±2°		
DRAWING TYPE		CUSTOMER		SHEET SIZE	SERIES
SCALE		1:1 SHEET 1 OF 1		A4	DS1040
DRAWING NO.		C-DS1040-XXN			

 晨翔电子有限公司
CONNFLY CONNFLY ELECTRONIC CO. LTD

Tel:86-574-6350878
 Fax:86-574-6351081
 E-mail:sale@zhenqi.com.cn
 Http://www.connfly.com.cn

REV.	DESCRIPTION	DRAWN	CHECKED	APPROVED
A	NEW RELEASE	YCH 12/13/08	~	

NOTES:

- 1.MECHANICAL
 - 1.1 Operation Force: 800g Max
 - 1.2 Stroke: 1.90mm
 - 1.3 Operation Temperature: -25°C~+80°C
 - 1.4 Storage Temperature: -45°C~+90°C
- 2.MATERIALS
 - 2.1 Base: Engineering Plastics,Black
 - 2.2 Cover: Engineering Plastics,Red or Blue
 - 2.3 Button: Engineering Plastics,White
 - 2.4 Terminal: Alloy Copper, Gold plating
- 3.ELECTRICAL
 - 3.1 Electrical Life: 2000 operations cycles per switch
 - 3.2 Non-Switching Rating: 100mA,50VDC
 - 3.3 Switching rating: 25mA,24VDC
 - 3.4 Contact resistance: 50mΩ Max. at initial; 100mΩ Max. after life test.
 - 3.5 Insulation Resistance: 100MΩ,500VDC
 - 3.6 Dielectric Strength: 500VAC/1 minute
 - 3.7 Circuit: Single pole single throw
4. PRODUCT NUMBER CODE:

DS1040 - X X X

- X Housing Type
- T: Piano
- X Housing color
- R: Red
- B: Blue
- K: Black
- N: Brown
- X Positions

02: 2pin 07: 7pin
 03: 3pin 08: 8pin
 04: 4pin 09: 9pin
 05: 5pin 10: 10pin
 06: 6pin 11: 11pin
 12: 12pin

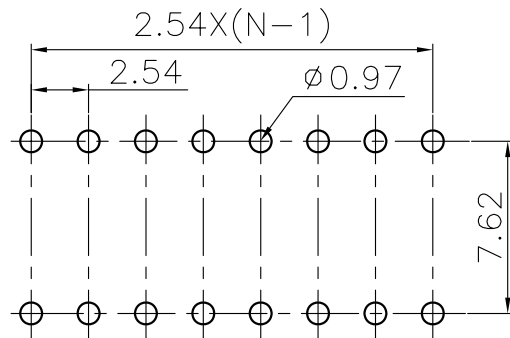
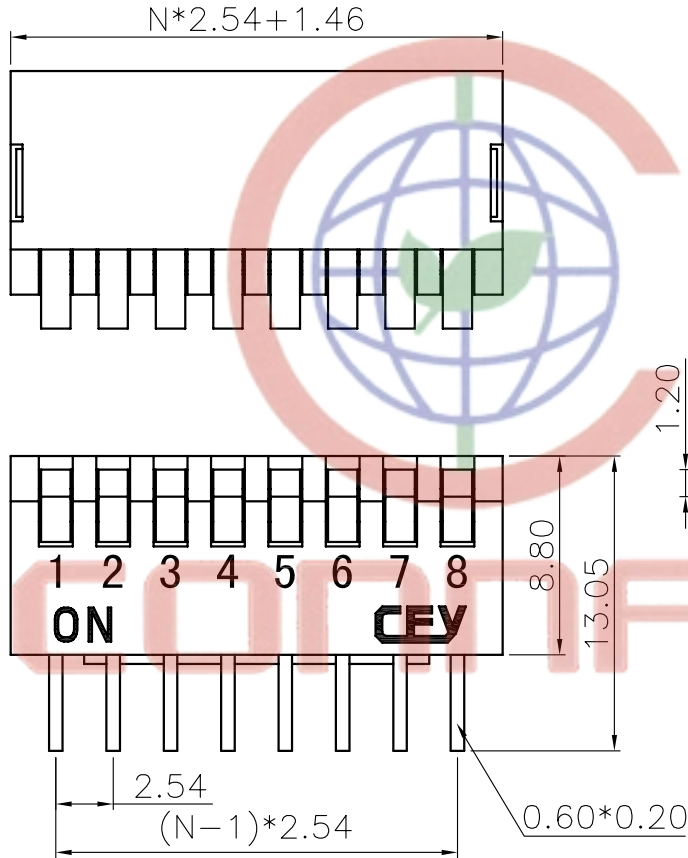

RECOMMEND PCB LAYOUT
 (TOLERANCE=±0.05)

GENERAL TOLERANCE		ANGLE TOLERANCE	
X.	±0.60	X.	±5°
.X	±0.38	.X	±3°
.XX	±0.25	.XX	±2°

PROJECTION	TITLE
UNITS	mm
SHEET SIZE	A4
SERIES	DS1040

DRAWING TYPE	CUSTOMER
SCALE	1:1 SHEET 1 OF 1
DRAWING NO.	C-DS1040-XXT



晨翔电子有限公司
CONNFLY CONNFLY ELECTRONIC CO. LTD

Tel:86-574-63508787
 Fax:86-574-6351081
 E-mail:sale@zhenqing.com.cn
 Http://www.connfly.com.cn

REV.	DESCRIPTION	DRAWN	CHECKED	APPROVED
A	NEW RELEASE	YCH 12/13/08	~	

NOTES:

- 1.MECHANICAL
 - 1.1 Operation Force: 1000g Max
 - 1.2 Stroke: 1.90mm
 - 1.3 Operation Temperature: -20°C~+85°C
 - 1.4 Storage Temperature: -40°C~+85°C
- 2.MATERIALS
 - 2.1 Base: Engineering Plastics,Black
 - 2.2 Cover: Engineering Plastics,Red or Blue
 - 2.3 Button: Engineering Plastics,White
 - 2.4 Terminal: Alloy Copper, Gold plating
- 3.ELECTRICAL
 - 3.1 Electrical Life: 2000 operations cycles per switch
 - 3.2 Non-Switching Rating: 100mA,50VDC
 - 3.3 Switching rating: 25mA,24VDC
 - 3.4 Contact resistance: 50mΩ Max. at initial; 100mΩ Max. after life test.
 - 3.5 Insulation Resistance: 100MΩ,500VDC
 - 3.6 Dielectric Strength: 500VAC/1 minute
 - 3.7 Circuit: Single pole single throw
4. PRODUCT NUMBER CODE:

DS1040 - X X X

- X Housing Type
- T: Piano
- X Housing color
- R: Red
- B: Blue
- K: Black
- N: Brown
- X Positions
- 01: 1pin

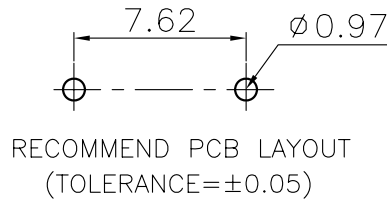
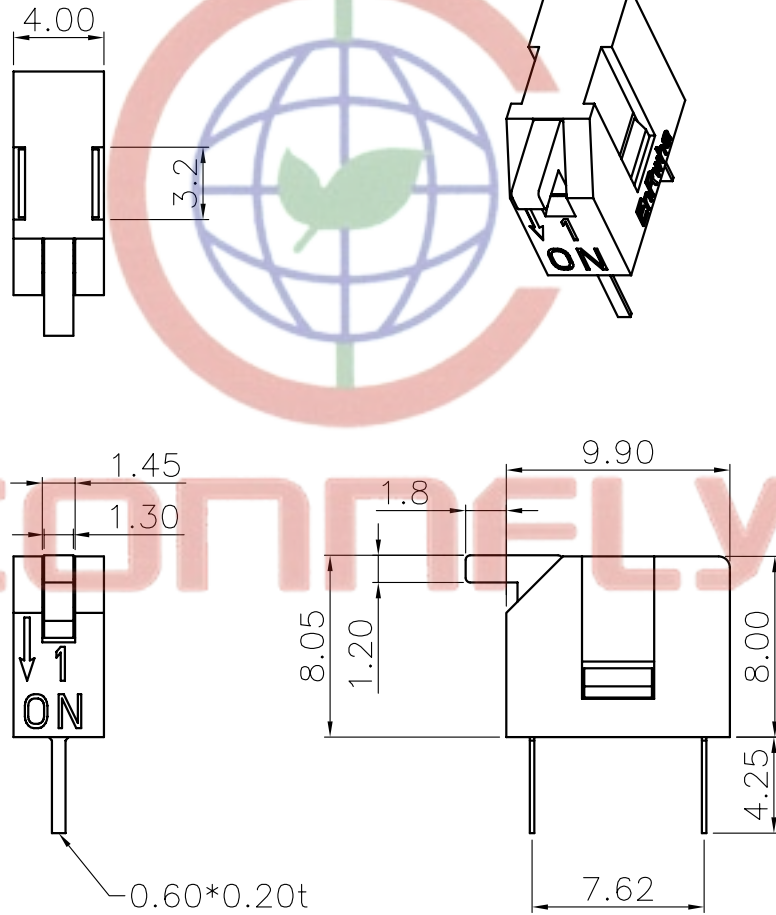

Tel:86-574-6350878
 Fax:86-574-6351081
 E-mail:sale@zhenqin.com.cn
 Http://www.connfly.com

GENERAL TOLERANCE		ANGLE TOLERANCE		PROJECTION		TITLE	
X.	±0.60	X.	±5°	UNITS	mm	DIP SWITCH	
.X	±0.38	.X	±3°	SHEET SIZE	A4	SERIES	DS1040
.XX	±0.25	.XX	±2°	晨翔电子有限公司 CONNFLY CONNFLY ELECTRONIC CO. LTD			
DRAWING TYPE		CUSTOMER					
SCALE	1:1	SHEET	1 OF 1				
DRAWING NO.		C-DS1040-1XT					