

The information provided herein is from CONNELY Electronic Co., Ltd. and is confidential. Any disclosure to a party other than the recipient is prohibited. The intellectual properties and its rights contained herein, including but not limited to, trademarks, patents, copyrights, trade secrets, and technical know-how, are owned exclusively by CONNELY or its affiliates. Unauthorized use or reproduction of any part of this document is strictly prohibited. CONNELY may enforce its intellectual property rights at its own discretion, failures or delays to exercise such rights does not constitute a waiver of such rights.

| REV. | DESCRIPTION | DRAWN | CHECKED | APPROVED |
|------|----------------|---------------|---------|---------------|
| A | NEW RELEASE | YCH 06/27/08' | | LJC 06/27/08' |
| D | DRAWING UPDATE | JLZ 04/28/20' | | |
| | | | | |

Female Terminal

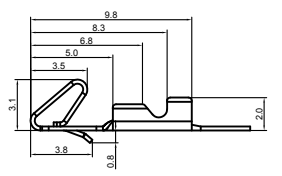

Female Terminal

| Wire Range | |
|--------------------------------|-------|
| Section Area (mm) ² | AWG# |
| 0.09~0.34 | 28~22 |

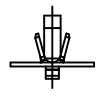

Female Housing

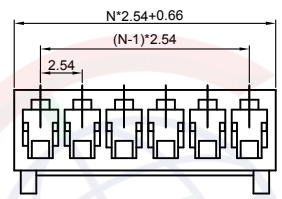
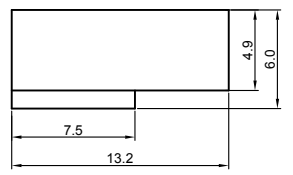

Male Right Angle

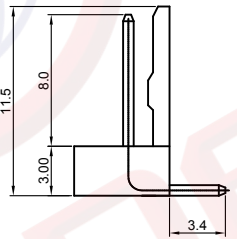
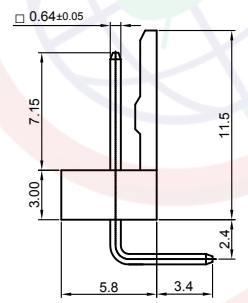
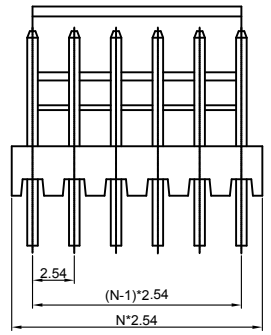

Type A

Type B

Male V/T type

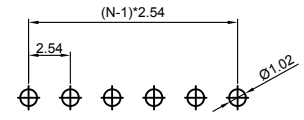
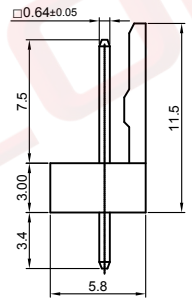
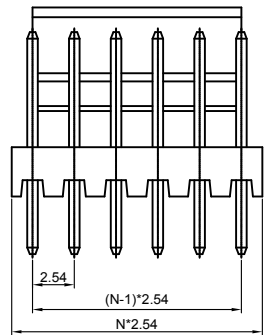

Recommend PCB Layout (Tolerance=±0.05)

N=Number Of Contacts

Notes:

- Electrical Characteristics:
 - Contact Resistance: 30mΩ Max.
 - Dielectric Withstanding Voltage: 600V AC(rms) For 1 Minute.
 - Insulation Resistance: 1000MΩ Min.
 - Current Rating:3A.
- Environment Characteristics:
 - Temperature: -25°C~+85°C.
- Materials:
 - Contact Material: Copper Alloy.
 - Contact Plating: Tin Plating Over Nickel.
 - Insulator Materials: Nylon.
- Product Number Code:

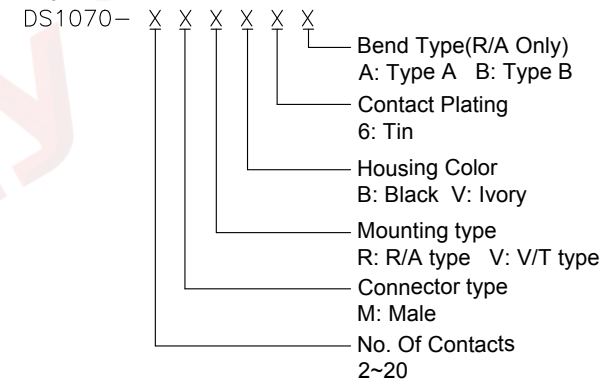

Female Housing:

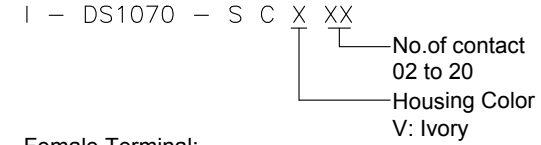

Female Terminal:



| GENERAL TOLERANCE | | ANGLE TOLERANCE | | PROJECTION | | TITLE |
|-------------------|-------|-------------------|-------|------------|----|----------------------------------|
| X. | ±0.60 | X. | ±5° | | | 2.54mm Wafer & Housing 2510 Type |
| .X | ±0.38 | .X | ±3° | | | |
| .XX | ±0.25 | .XX | ±2° | | | |
| DRAWING TYPE | | CUSTOMER | | UNITS | mm | |
| SCALE | | 1:1 | SHEET | 1 OF 1 | | |
| DRAWING NO. | | C-DS1070-XXXXXX-D | | SHEET SIZE | A4 | SERIES DS1070 SERIES |

晨翔电子有限公司
 CONNELY CONNELY ELECTRONIC CO. LTD