

The information provided herein is from CONNELY Electronic Co., Ltd. and is confidential. Any disclosure to a party other than the recipient is prohibited. The intellectual properties and its rights contained herein, including but not limited to, trademarks, patents, copyrights, trade secrets, and technical know-how, are owned exclusively by CONNELY or its affiliates. Unauthorized use or reproduction of any part of this document, in any form or by any means, without the prior written permission of CONNELY is strictly prohibited. CONNELY may enforce its intellectual property rights at its own discretion, failures or delays to exercise such rights does not constitute a waiver of such rights.

REV.	DESCRIPTION	DRAWN	CHECKED	APPROVED
A	NEW RELEASE	YCH 06/27/08'		LJC 06/27/08'
D	DRAWING UPDATE	JLZ 04/28/20'		

**Female Terminal**

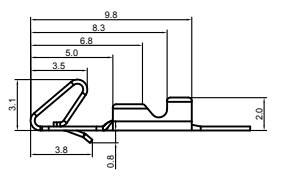

**Female Terminal**

Wire Range	
Section Area (mm) <sup>2</sup>	AWG#
0.09~0.34	28~22

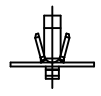

**Female Housing**

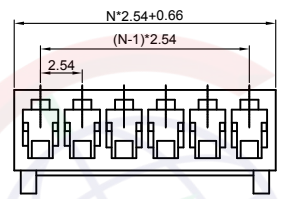
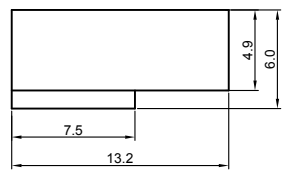

**Male Right Angle**

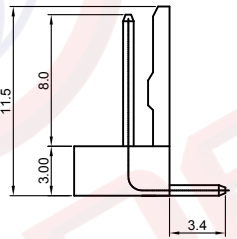
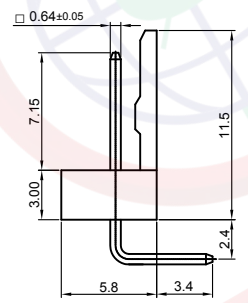
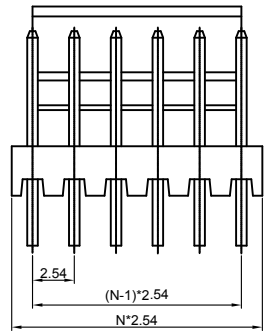

Type A

Type B

**Male V/T type**

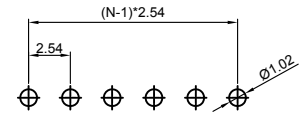
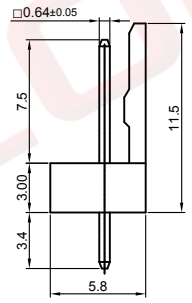
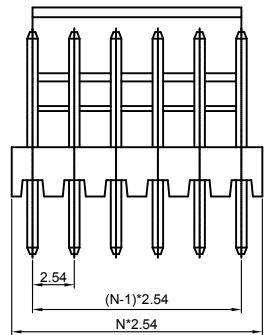

Recommend PCB Layout (Tolerance=±0.05)

N=Number Of Contacts

**Notes:**

- Electrical Characteristics:
  - Contact Resistance: 30mΩ Max.
  - Dielectric Withstanding Voltage: 600V AC(rms) For 1 Minute.
  - Insulation Resistance: 1000MΩ Min.
  - Current Rating: 3A.
- Environment Characteristics:
  - Temperature: -25°C~+85°C.
- Materials:
  - Contact Material: Copper Alloy.
  - Contact Plating: Tin Plating Over Nickel.
  - Insulator Materials: Nylon.
- Product Number Code:

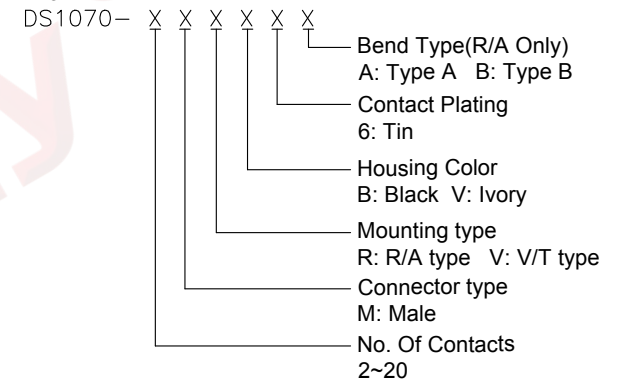

**Female Housing:**

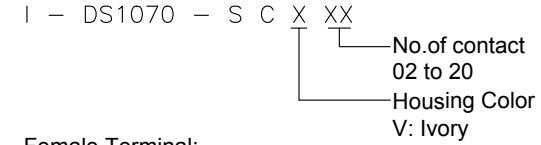

**Female Terminal:**



GENERAL TOLERANCE		ANGLE TOLERANCE		PROJECTION		TITLE	2.54mm Wafer & Housing 2510 Type		
X.	±0.60	X.	±5°	UNITS	mm	SHEET	DS1070 SERIES		
.X	±0.38	.X	±3°	SHEET SIZE	A4	SERIES	DS1070 SERIES		
.XX	±0.25	.XX	±2°						
DRAWING TYPE		CUSTOMER			<b>晨翔电子有限公司</b> CONNELY ELECTRONIC CO., LTD				
SCALE		1:1							
DRAWING NO.		C-DS1070-XXXXXX-D							